



“Supporting Healthcare”

**KAAHA INDUSTRIES**

Manufacturer Of Dental & Surgical Instruments



**PLASTIC SURGERY  
INSTRUMENTS  
CATALOGUE**

*Friendly Specialist*  
**SERVICE**

[www.kaahaindustries.com](http://www.kaahaindustries.com)





**Epstein Abdominoplasty Retractor With Fiber Optic And SuctionTube, Straight Blade**

Size	With Light Guide & Suction	With Light Guide	Retractor Only	Suction Only
80 X 27 mm	<b>KI-02-01</b>	<b>KI-03-01</b>	<b>KI-04-01</b>	<b>KI-05-01</b>
110 X 27 mm	<b>KI-02-02</b>	<b>KI-03-02</b>	<b>KI-04-02</b>	<b>KI-05-02</b>
140 X 27 mm	<b>KI-02-03</b>	<b>KI-03-03</b>	<b>KI-04-03</b>	<b>KI-05-03</b>
160 X 27 mm	<b>KI-02-04</b>	<b>KI-03-04</b>	<b>KI-04-04</b>	<b>KI-05-04</b>
240 X 27 mm	<b>KI-02-05</b>	<b>KI-03-05</b>	<b>KI-04-05</b>	<b>KI-05-05</b>



**Epstein Abdominoplasty Retractor With Fiber Optic And SuctionTube, Curved Blade**

Size	With Light Guide & Suction	With Light Guide	Retractor Only	Suction Only
80 X 27 mm	<b>KI-06-01</b>	<b>KI-07-01</b>	<b>KI-08-01</b>	<b>KI-09-01</b>
110 X 27 mm	<b>KI-06-02</b>	<b>KI-07-02</b>	<b>KI-08-02</b>	<b>KI-09-02</b>
140 X 27 mm	<b>KI-06-03</b>	<b>KI-07-03</b>	<b>KI-08-03</b>	<b>KI-09-03</b>
160 X 27 mm	<b>KI-06-04</b>	<b>KI-07-04</b>	<b>KI-08-04</b>	<b>KI-09-04</b>
240 X 27 mm	<b>KI-06-05</b>	<b>KI-07-05</b>	<b>KI-08-05</b>	<b>KI-09-05</b>



## Haynes Breast Retractor, Slotted Blade With Teeth With Fiber Optic Light Guide

Size	With Light Guide	Retractor Only
90 X 32 mm	KI-10-01	KI-11-01
140 X 32 mm	KI-10-02	KI-11-02



## FERRIERA STYLE BREAST RETRACTOR

Size	With Light Guide & Suction	With Light Guide	Retractor Only	Suction Only
70 X 16 mm	KI-12-01	KI-13-01	KI-14-01	KI-15-01
80 X 16 mm	KI-12-02	KI-13-02	KI-14-02	KI-15-02
90 X 27 mm	KI-12-03	KI-13-03	KI-14-03	KI-15-03
110 X 25 mm	KI-12-04	KI-13-04	KI-14-04	KI-15-04
120 X 25 mm	KI-12-05	KI-13-05	KI-14-05	KI-15-05
130 X 16 mm	KI-12-06	KI-13-06	KI-14-06	KI-15-06
130 X 25 mm	KI-12-07	KI-13-07	KI-14-07	KI-15-07
150 X 25 mm	KI-12-08	KI-13-08	KI-14-08	KI-15-08
150 X 30 mm	KI-12-09	KI-13-09	KI-14-09	KI-15-09
150 X 36 mm	KI-12-10	KI-13-10	KI-14-10	KI-15-10
180 X 16 mm	KI-12-11	KI-13-11	KI-14-11	KI-15-11
180 X 25 mm	KI-12-12	KI-13-12	KI-14-12	KI-15-12
190 X 25 mm	KI-12-13	KI-13-13	KI-14-13	KI-15-13
190 X 36 mm	KI-12-14	KI-13-14	KI-14-14	KI-15-14
220 X 27 mm	KI-12-15	KI-13-15	KI-14-15	KI-15-15



**Ferriera Style Breast Fiber Optic Retractor, With  
 Double Handle and Smooth End**

Size	With Light Guide & Suction	With Light Guide	Retractor Only	Suction Only
70 X 16 mm	<b>KI-16-01</b>	<b>KI-17-01</b>	<b>KI-18-01</b>	<b>KI-19-01</b>
80 X 16 mm	<b>KI-16-02</b>	<b>KI-17-02</b>	<b>KI-18-02</b>	<b>KI-19-02</b>
90 X 27 mm	<b>KI-16-03</b>	<b>KI-17-03</b>	<b>KI-18-03</b>	<b>KI-19-03</b>
110 X 25 mm	<b>KI-16-04</b>	<b>KI-17-04</b>	<b>KI-18-04</b>	<b>KI-19-04</b>
120 X 25 mm	<b>KI-16-05</b>	<b>KI-17-05</b>	<b>KI-18-05</b>	<b>KI-19-05</b>
130 X 16 mm	<b>KI-16-06</b>	<b>KI-17-06</b>	<b>KI-18-06</b>	<b>KI-19-06</b>
130 X 25 mm	<b>KI-16-07</b>	<b>KI-17-07</b>	<b>KI-18-07</b>	<b>KI-19-07</b>
150 X 25 mm	<b>KI-16-08</b>	<b>KI-17-08</b>	<b>KI-18-08</b>	<b>KI-19-08</b>
150 X 30 mm	<b>KI-16-09</b>	<b>KI-17-09</b>	<b>KI-18-09</b>	<b>KI-19-09</b>
150 X 36 mm	<b>KI-16-10</b>	<b>KI-17-10</b>	<b>KI-18-10</b>	<b>KI-19-10</b>
180 X 16 mm	<b>KI-16-11</b>	<b>KI-17-11</b>	<b>KI-18-11</b>	<b>KI-19-11</b>
180 X 25 mm	<b>KI-16-12</b>	<b>KI-17-12</b>	<b>KI-18-12</b>	<b>KI-19-12</b>
190 X 25 mm	<b>KI-16-13</b>	<b>KI-17-13</b>	<b>KI-18-13</b>	<b>KI-19-13</b>
190 X 36 mm	<b>KI-16-14</b>	<b>KI-17-14</b>	<b>KI-18-14</b>	<b>KI-19-14</b>
220 X 27 mm	<b>KI-16-15</b>	<b>KI-17-15</b>	<b>KI-18-15</b>	<b>KI-19-15</b>

## Tebbetts Fibre Optic Breast Retractor

With fibre optic illumination and suction

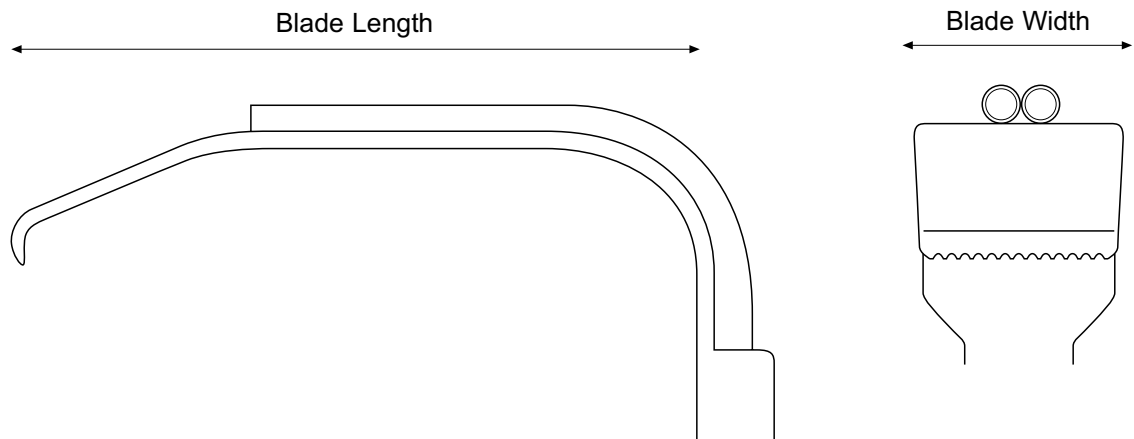

### Tebbetts Fibre Optic Breast Retractor

Size	With Light Guide & Suction	With Light Guide	Retractor Only	Suction Only
70 X 16 mm	<b>KI-20-01</b>	<b>KI-21-01</b>	<b>KI-22-01</b>	<b>KI-23-01</b>
80 X 16 mm	<b>KI-20-02</b>	<b>KI-21-02</b>	<b>KI-22-02</b>	<b>KI-23-02</b>
90 X 27 mm	<b>KI-20-03</b>	<b>KI-21-03</b>	<b>KI-22-03</b>	<b>KI-23-03</b>
110 X 25 mm	<b>KI-20-04</b>	<b>KI-21-04</b>	<b>KI-22-04</b>	<b>KI-23-04</b>
120 X 25 mm	<b>KI-20-05</b>	<b>KI-21-05</b>	<b>KI-22-05</b>	<b>KI-23-05</b>
130 X 16 mm	<b>KI-20-06</b>	<b>KI-21-06</b>	<b>KI-22-06</b>	<b>KI-23-06</b>
130 X 25 mm	<b>KI-20-07</b>	<b>KI-21-07</b>	<b>KI-22-07</b>	<b>KI-23-07</b>
150 X 25 mm	<b>KI-20-08</b>	<b>KI-21-08</b>	<b>KI-22-08</b>	<b>KI-23-08</b>
150 X 30 mm	<b>KI-20-09</b>	<b>KI-21-09</b>	<b>KI-22-09</b>	<b>KI-23-09</b>
150 X 36 mm	<b>KI-20-10</b>	<b>KI-21-10</b>	<b>KI-22-10</b>	<b>KI-23-10</b>
180 X 16 mm	<b>KI-20-11</b>	<b>KI-21-11</b>	<b>KI-22-11</b>	<b>KI-23-11</b>
180 X 25 mm	<b>KI-20-12</b>	<b>KI-21-12</b>	<b>KI-22-12</b>	<b>KI-23-12</b>
190 X 25 mm	<b>KI-20-13</b>	<b>KI-21-13</b>	<b>KI-22-13</b>	<b>KI-23-13</b>
190 X 36 mm	<b>KI-20-14</b>	<b>KI-21-14</b>	<b>KI-22-14</b>	<b>KI-23-14</b>
220 X 27 mm	<b>KI-20-15</b>	<b>KI-21-15</b>	<b>KI-22-15</b>	<b>KI-23-15</b>



**TEBBETTS RETRACTOR**, With Double Handle and Teeth at tip

Size	With Light Guide & Suction	With Light Guide	Retractor Only	Suction Only
70 X 16 mm	KI-24-01	KI-25-01	KI-26-01	KI-27-01
80 X 16 mm	KI-24-02	KI-25-02	KI-26-02	KI-27-02
90 X 27 mm	KI-24-03	KI-25-03	KI-26-03	KI-27-03
110 X 25 mm	KI-24-04	KI-25-04	KI-26-04	KI-27-04
120 X 25 mm	KI-24-05	KI-25-05	KI-26-05	KI-27-05
130 X 16 mm	KI-24-06	KI-25-06	KI-26-06	KI-27-06
130 X 25 mm	KI-24-07	KI-25-07	KI-26-07	KI-27-07
150 X 25 mm	KI-24-08	KI-25-08	KI-26-08	KI-27-08
150 X 30 mm	KI-24-09	KI-25-09	KI-26-09	KI-27-09
150 X 36 mm	KI-24-10	KI-25-10	KI-26-10	KI-27-10
180 X 16 mm	KI-24-11	KI-25-11	KI-26-11	KI-27-11
180 X 25 mm	KI-24-12	KI-25-12	KI-26-12	KI-27-12
190 X 25 mm	KI-24-13	KI-25-13	KI-26-13	KI-27-13
190 X 36 mm	KI-24-14	KI-25-14	KI-26-14	KI-27-14
220 X 27 mm	KI-24-15	KI-25-15	KI-26-15	KI-27-15

## TEBBETTS RETRACTOR, Insulated Blade with Teeth

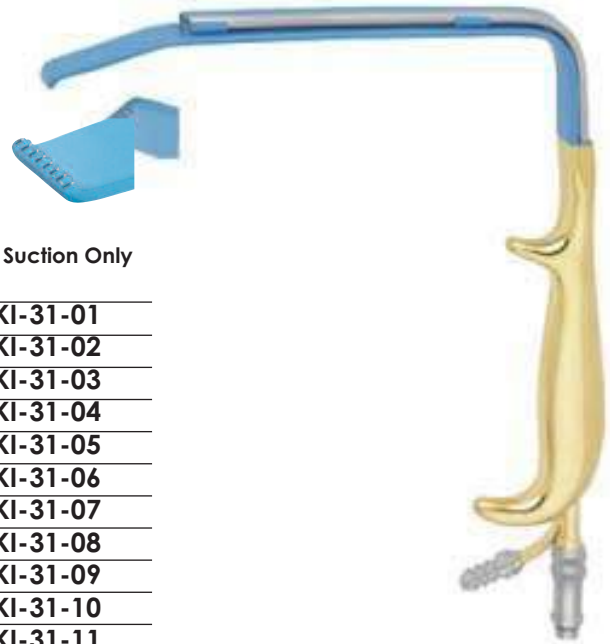

Size	With Light Guide & Suction	With Light Guide	Retractor Only	Suction Only
70 X 16 mm	KI-28-01	KI-29-01	KI-30-01	KI-31-01
80 X 16 mm	KI-28-02	KI-29-02	KI-30-02	KI-31-02
90 X 27 mm	KI-28-03	KI-29-03	KI-30-03	KI-31-03
110 X 25 mm	KI-28-04	KI-29-04	KI-30-04	KI-31-04
120 X 25 mm	KI-28-05	KI-29-05	KI-30-05	KI-31-05
130 X 16 mm	KI-28-06	KI-29-06	KI-30-06	KI-31-06
130 X 25 mm	KI-28-07	KI-29-07	KI-30-07	KI-31-07
150 X 25 mm	KI-28-08	KI-29-08	KI-30-08	KI-31-08
150 X 30 mm	KI-28-09	KI-29-09	KI-30-09	KI-31-09
150 X 36 mm	KI-28-10	KI-29-10	KI-30-10	KI-31-10
180 X 16 mm	KI-28-11	KI-29-11	KI-30-11	KI-31-11
180 X 25 mm	KI-28-12	KI-29-12	KI-30-12	KI-31-12
190 X 25 mm	KI-28-13	KI-29-13	KI-30-13	KI-31-13
190 X 36 mm	KI-28-14	KI-29-14	KI-30-14	KI-31-14
220 X 27 mm	KI-28-15	KI-29-15	KI-30-15	KI-31-15

## Ferriera Style Breast Fiber Optic Retractor, Insulated Blade With Smooth End

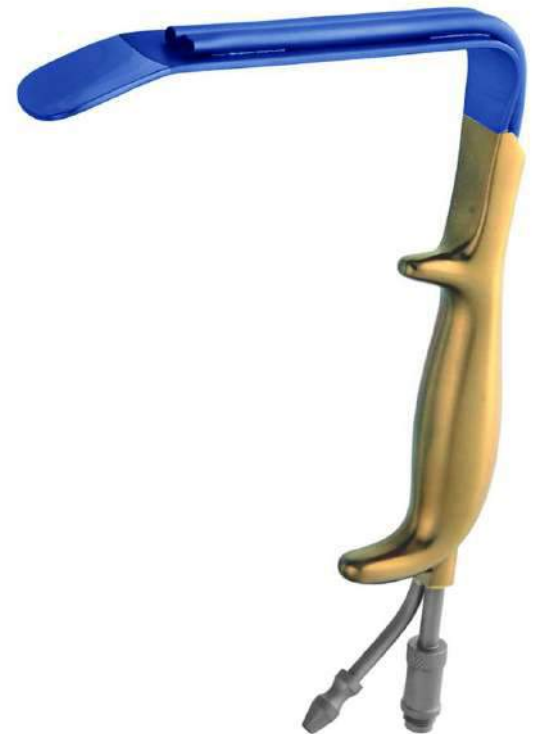

Size	With Light Guide & Suction	With Light Guide	Retractor Only	Suction Only
70 X 16 mm	KI-32-01	KI-33-01	KI-34-01	KI-35-01
80 X 16 mm	KI-32-02	KI-33-02	KI-34-02	KI-35-02
90 X 27 mm	KI-32-03	KI-33-03	KI-34-03	KI-35-03
110 X 25 mm	KI-32-04	KI-33-04	KI-34-04	KI-35-04
120 X 25 mm	KI-32-05	KI-33-05	KI-34-05	KI-35-05
130 X 16 mm	KI-32-06	KI-33-06	KI-34-06	KI-35-06
130 X 25 mm	KI-32-07	KI-33-07	KI-34-07	KI-35-07
150 X 25 mm	KI-32-08	KI-33-08	KI-34-08	KI-35-08
150 X 30 mm	KI-32-09	KI-33-09	KI-34-09	KI-35-09
150 X 36 mm	KI-32-10	KI-33-10	KI-34-10	KI-35-10
180 X 16 mm	KI-32-11	KI-33-11	KI-34-11	KI-35-11
180 X 25 mm	KI-32-12	KI-33-12	KI-34-12	KI-35-12
190 X 25 mm	KI-32-13	KI-33-13	KI-34-13	KI-35-13
190 X 36 mm	KI-32-14	KI-33-14	KI-34-14	KI-35-14
220 X 27 mm	KI-32-15	KI-33-15	KI-34-15	KI-35-15



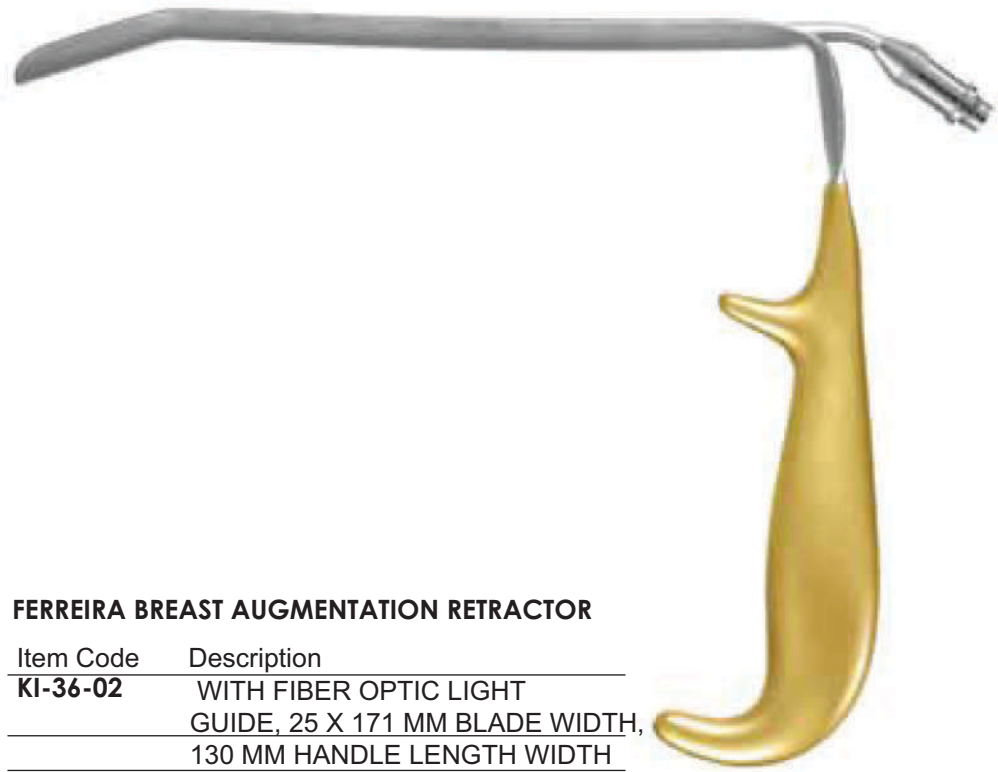

### FERREIRA BREAST AUGMENTATION RETRACTOR

Item Code	Description
<b>KI-36-02</b>	WITH FIBER OPTIC LIGHT GUIDE, 25 X 171 MM BLADE WIDTH, 130 MM HANDLE LENGTH WIDTH



### Sculpo Breast Retractors

Item Code	Description
<b>KI-37-02</b>	180 X 25mm, Blade Size, With 5mm Endoscopic Scope Sheath
<b>KI-38-02</b>	180 X 25mm, Blade Size, With 10mm Endoscopic Scope Sheath



## Ring Breast Retractor

with fiber optic illumination and irrigation tube

Description

KI-39-01



## Ring Breast Retractor

with fiber optic illumination and irrigation tube, Insulated

Description

KI-40-01



### BIGGS MAMMAPLASTY RETRACTOR

Item Code	Description
<b>KI-41-01</b>	WITH FIBER OPTIC LIGHT GUIDE 5.0 CM BLADE WIDTH, 20 CM LENGTH

### BIGGS MAMMAPLASTY RETRACTOR

Item Code	Description
<b>KI-42-01</b>	WITH FIBER OPTIC LIGHT GUIDE, NARROW, 3.0 CM BLADE WIDTH, 15 CM LENGTH





## BIGGS MAMMAPLASTY RETRACTORS

Item Code	Description
<b>KI-43-01</b>	30MM, WITH FIBER OPTIC LIGHT GUIDE
<b>KI-43-02</b>	50MM, WITH FIBER OPTIC LIGHT GUIDE
<b>KI-43-03</b>	30MM, WITH FIBER OPTIC LIGHT GUIDE AND SUCTION
<b>KI-43-04</b>	50MM, WITH FIBER OPTIC LIGHT GUIDE AND SUCTION



## Miller Wave Retractor

Item Code	Description
<b>KI-44-01</b>	WITHOUT FIBER OPTIC LIGHT GUIDE
<b>KI-44-02</b>	WITH FIBER OPTIC LIGHT GUIDE
<b>KI-44-03</b>	WITH FIBER OPTIC LIGHT GUIDE AND SUCTION

## Fibre Optic Light Lead

<i>Code</i>	<i>Length</i>	<i>Diameter</i>
<b>KI-45-01</b>	225cm	4.0mm Ø
<b>KI-45-02</b>	250cm	4.0mm Ø
<b>KI-45-03</b>	300cm	4.0mm Ø
<b>KI-45-04</b>	400cm	4.0mm Ø



## Adaptors for Light Lead

Lightsource Fittings



Retractor Fitting



## Wireless LED Light Source For Fiber Optic Retractor ( Great LED White Light )

KI-46-01



**Emory Endoscopic Retractor, With Locking Mechanism**  
**1 X 7 Inch Blades, For 10mm Scope**

KI-49-01



**Harrington Wide Retractor With Fiber**  
**Optics Illumination, 32cm**

KI-50-01



**Aufricht Retractor With Fiber Optic  
Illumination 20cm, Fixed**  
KI-51-01



**Aufricht Retractor With Fiber Optic  
Illumination 20cm**  
KI-52-01





**BIGGS face lift retractor, 50 mm, Retractor Only, Length (23cm)  
KI-53-01**

**BIGGS face lift retractor, 50 mm, With Fiber Optic Guide, Length (23cm)  
KI-54-01**

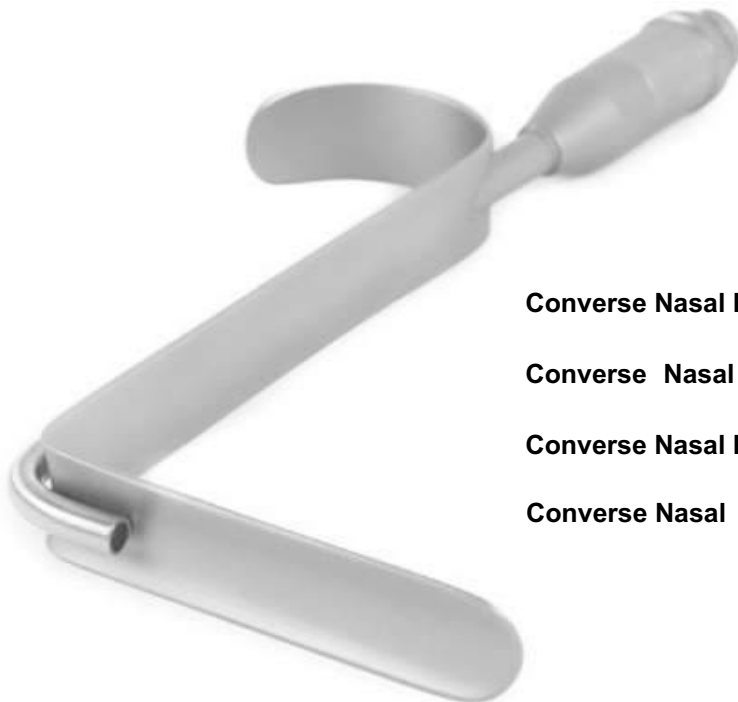

**Converse Nasal Retractor With Fiber Optic 20mm x 10mm Wide  
KI-55-01**

**Converse Nasal Retractor With Fiber Optic 30mm x 12mm Wide  
KI-56-01**

**Converse Nasal Retractor With Fiber Optic 40mm x 12mm Wide  
KI-57-01**

**Converse Nasal Retractor With Fiber Optic 50mm x 12mm Wide  
KI-58-01**



**Weider Breast And Facial Retractor With Fiber Optic Light Guide 14cm**

**KI-59-01**

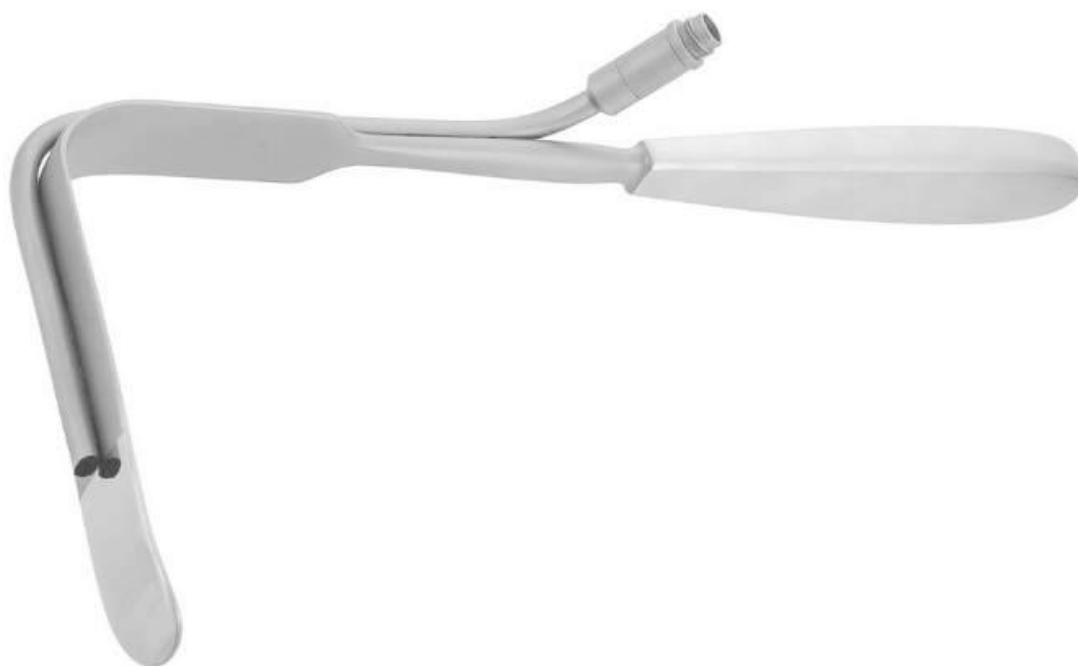

**Heaney Simon Retractor With Fiber Optic Guide Light 130mm x 25mm Blade Width**

**KI-60-01**



Cottle **Nasal Speculum 14CM,**  
WITH FIBER OPTIC LIGHT GUIDE

Item Code	Description
<b>KI-61-40</b>	40MM WIDE
<b>KI-61-55</b>	55MM WIDE
<b>KI-61-75</b>	75MM WIDE
<b>KI-61-90</b>	90MM WIDE,



Killian **Nasal Speculum 14CM,**  
WITH FIBER OPTIC LIGHT GUIDE

Item Code	Description
<b>KI-62-40</b>	40MM WIDE
<b>KI-62-55</b>	55MM WIDE
<b>KI-62-75</b>	75MM WIDE
<b>KI-62-90</b>	90MM WIDE,



Maliniac Nasal Retractor 9mm x 45mm Blade Size, With Fiber Optic Guide Light

**KI-63-01**

Maliniac Nasal Retractor 11mm x 44mm Blade Size, With Fiber Optic Guide Light

**KI-64-01**

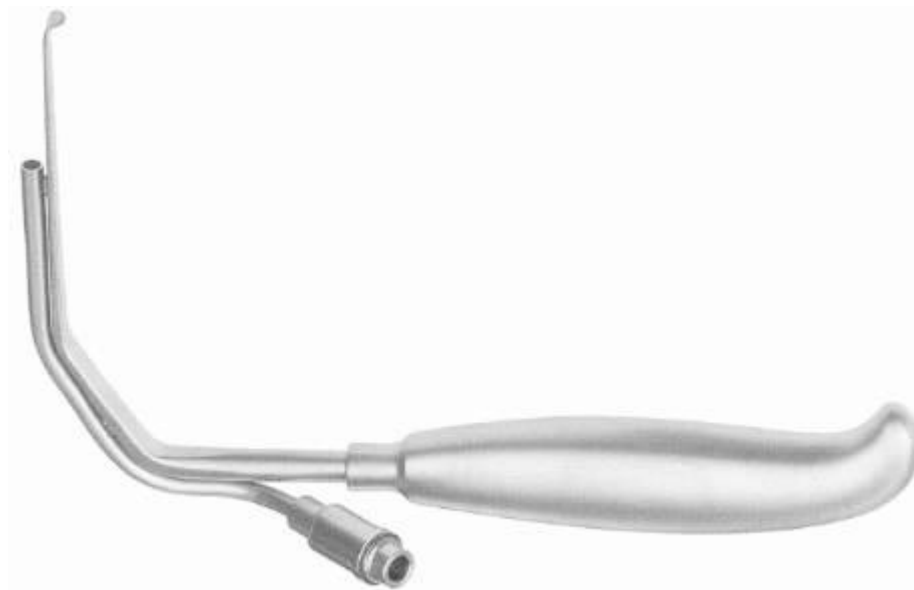

**Walter Alar and Nasal Retractor, 18.5cm**

**KI-65-01**



Deaver Retractor With Fiber Optic Illumination 20cm 16mm Wide

**KI-66-01**

Deaver Retractor With Fiber Optic Illumination 20cm 25mm Wide

**KI-67-01**



Freeman Flap Retractor 20cm 12mm Blade Wide, With Fiber Optic Guide Light

**KI-68-01**

Freeman Flap Retractor 20cm 25mm Blade Wide, With Fiber Optic Guide Light

**KI-69-01**



KI-70.01  
28 cm / 11"

***Mammoplast Breast Retractor***

Self retaining ratchet  
Adjustable to hold breast during surgery



## BREAST RETRACTOR

Item Code	Description
<b>KI-71.01</b>	DOUBLE ENDED, (31 CM), BLADES 22MM X 55MM AND 38MM X 70MM
<b>KI-72.02</b>	DOUBLE ENDED, (24 CM), BLADES 22MM X 55MM AND 38MM X 70MM



## BREAST RETRACTOR INSULATED

Item Code	Description
<b>KI-73.01</b>	DOUBLE ENDED, (31 CM), BLADES 22MM X 55MM AND 38MM X 70MM
<b>KI-74.02</b>	DOUBLE ENDED, (24 CM), BLADES 22MM X 55MM AND 38MM X 70MM



### BREAST RETRACTOR

Item Code	Description
<b>KI-75.01</b>	DOUBLE ENDED, (31 CM), BLADES 22MM X 55MM AND 38MM X 70MM
<b>KI-76.02</b>	DOUBLE ENDED, (24 CM), BLADES 22MM X 55MM AND 38MM X 70MM



### BREAST RETRACTOR INSULATED

Item Code	Description
<b>KI-77.01</b>	DOUBLE ENDED, (31 CM), BLADES 22MM X 55MM AND 38MM X 70MM
<b>KI-78.02</b>	DOUBLE ENDED, (24 CM), BLADES 22MM X 55MM AND 38MM X 70MM





### BIGGS MAMMAPLASTY RETRACTOR,

Item Code	Description
<b>KI-79.01</b>	3 CM BLADE WIDTH, NARROW, (171 MM) LENGTH



### BIGGS MAMMAPLASTY RETRACTOR

Item Code	Description
<b>KI-80.01</b>	50 MM WIDTH, STANDARD, 20 CM LENGTH



### MARX BREAST RETRACTOR

Item Code	Description
<b>KI-81.01</b>	27CM, 125 X 30MM
<b>KI-82.02</b>	27CM, 140 X 30MM

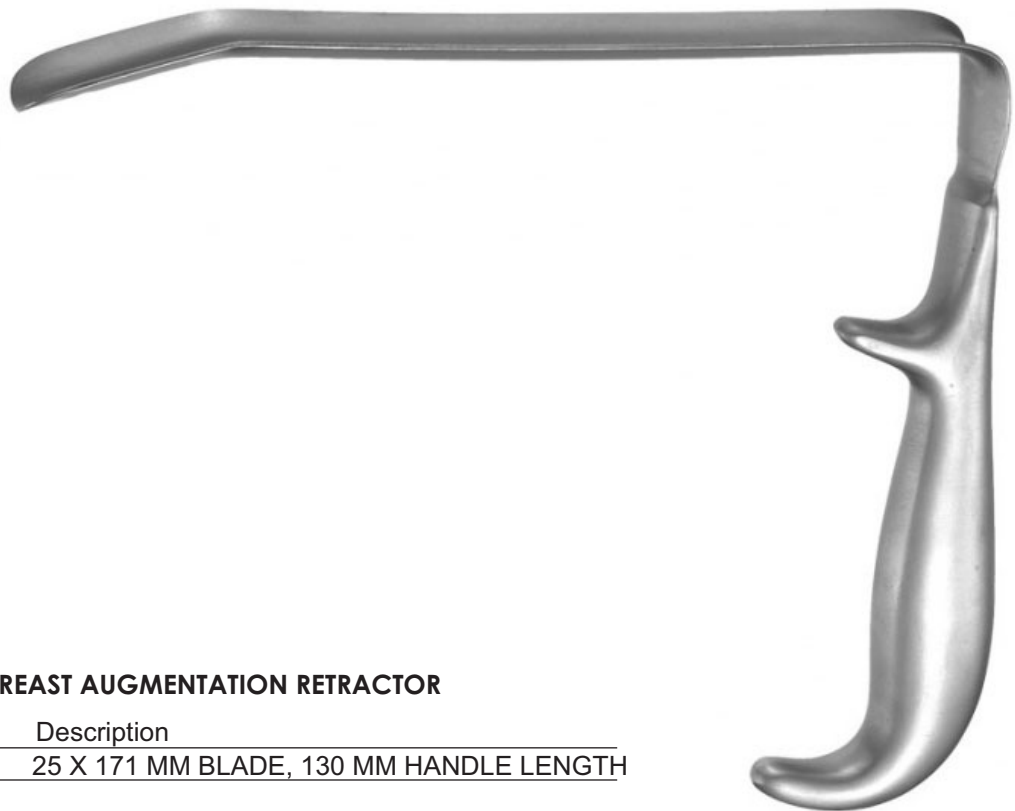

### FERREIRA BREAST AUGMENTATION RETRACTOR

Item Code	Description
<b>KI-83.01</b>	25 X 171 MM BLADE, 130 MM HANDLE LENGTH



## WIEDER BREAST AND FACIAL RETRACTOR / TONGUE DEKISSOR

Item Code	Description
<b>KI-84.01</b>	SERRATED, (14 CM), 28MM
<b>KI-85.02</b>	SERRATED, (14 CM), 38MM
<b>KI-86.03</b>	SERRATED, (15 CM), 45MM



**MACCOLLUM DINGMAN BREAST DISSECTOR**

Item Code	Description
<b>KI-90.01</b>	31.5 CM
<b>KI-91.02</b>	41 CM



**MACCOLLUM DINGMAN SUBMAMMARY DISSECTOR**

Item Code	Description
<b>KI-92.01</b>	30 CM



**MACCOLLUM DINGMAN BREAST DISSECTOR**

Item Code	Description
<b>KI-93.01</b>	1½" (38 MM) WIDTH, 17½" (432 MM) LENGTH



**BREAST DISSECTOR**

Item Code	Description
<b>KI-94.01</b>	SPATULATED BLADE, 33CM
<b>KI-95.02</b>	SPATULATED BLADE, 42CM



**BREAST DISSECTOR**

Item Code	Description
<b>KI-96.01</b>	OVAL SPATULATED BLADE, 33CM
<b>KI-97.02</b>	OVAL SPATULATED BLADE, 42CM



**BREAST DISSECTOR**

Item Code	Description
<b>KI-98.01</b>	ANGULATED BLADE, 33CM
<b>KI-99.02</b>	ANGULATED BLADE, 42CM



**REYNOLDS TRANSAUXILLARY BREAST DISSECTOR**

Item Code	Description
<b>KI-100.01</b>	FENESTRATED, 33CM
<b>KI-101.02</b>	FENESTRATED, 40CM



**SILVERSTEIN BREAST DISSECTOR**

Item Code	Description
<b>KI-102.01</b>	14" (356 MM) LENGTH



**SPATULA BREAST RETRACTOR / DISSECTOR**

Item Code	Description
<b>KI-103.01</b>	SERRATED, 12½", SEMI MALLEABLE



**LOCKWOOD Underminer Dissector**

Item Code	Description
<b>KI-104.01</b>	38cm, Length, 3cm Lift



**MCINNIS POLYCURETTE BREAST INSTRUMENT**

Item Code	Description
<b>KI-105.01</b>	11¾" (300 MM) WIDTH, 12½" (318 MM) LENGTH



**JACOBS TRANSAXILLARY DISSECTOR**

Item Code	Description
<b>KI-106.01</b>	CURVED SHAFT CHISEL EDGE 17" (432 mm) WIDTH ½" (13mm)



**WIESLANDER TRANSAXILLARY BREAST DISSECTOR**

Item Code	Description
<b>KI-107.01</b>	LENGTH 18 1/8" (460mm) WIDTH 1" (25mm)
<b>KI-108.02</b>	LENGTH 17" (432mm) WIDTH 1-3/8" (35mm)



**REYNOLDS TRANSAXILLARY BREAST DISSECTOR**

Item Code	Description
<b>KI-109.01</b>	15 ¾" (400mm) 1½" (38mm)



**TROCAR BREAST TUBE**

Item Code	Description
<b>KI-110.01</b>	14" (356 MM), LARGE, 17.3 MM ID, 19.0 MM OD
<b>KI-111.02</b>	13 ½" (343MM), SMALL, 14 MM ID, 16 MM OD



### SOLZ ATRAUMATIC BREAST DISSECTOR

Item Code	Description
KI-112.01	34CM
KI-113.02	37CM



### SOLZ BREAST HOOK DISSECTOR

Item Code	Description
KI-114.01	SET OF 2, LEFT AND RIGHT, 36CM



### BREAST SPATULA

Item Code	Description
KI-116.01	WITH HANDLE 31.5 CM, 25MM X 18 CM BLADE, SERRATED TIP, SEMI MALLABLE



### Breast And Facial Spreader

Item Code	Description
<b>KI-117.01</b>	LARGE, 11½" (292 MM) LENGTH, 5¾" (146 MM) BLADE
<b>KI-118.02</b>	SMALL, 8¾" (222 MM) LENGTH, 3¼" (83 MM) BLADE



### ICONOCLAST

Item Code	Description
<b>KI-119.01</b>	LARGE, 11½" (292 MM) LENGTH, 5¾" (146 MM) BLADE
<b>KI-120.02</b>	SMALL, 8¾" (222 MM) LENGTH, 3¼" (83 MM) BLADE





**FRONTOTEMPORAL DISSECTOR**

Item Code	Description
<b>KI-121.01</b>	9" (22.5 CM), 5MM TIP, SLIGHTLY CURVED
<b>KI-122.02</b>	9" (23 CM), 7MM TIP, SLIGHTLY CURVED
<b>KI-123.03</b>	9" (23 CM), 10MM TIP, SLIGHTLY CURVED



**FLAP DISSECTOR**

Item Code	Description
<b>KI-124.01</b>	9½" (23.5 CM), 5MM TIP, STRAIGHT



**TEMPORAL T DISSECTOR**

Item Code	Description
<b>KI-125.01</b>	9½" (23.5 CM), 12MM TIP, STRAIGHT



**FRONTOGLABELLAR DISSECTOR**

Item Code	Description
<b>KI-126.01</b>	10½" (26.5 CM), 7MM TIP, S SHAPED

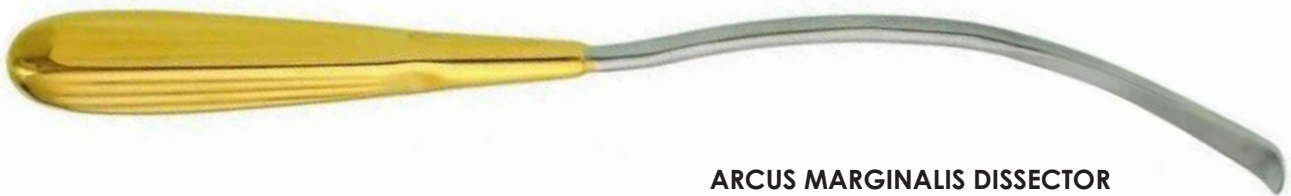

**ARCUS MARGINALIS DISSECTOR**

Item Code	Description
<b>KI-127.01</b>	9 3/4" (24 CM), 10MM TIP, S SHAPED



**FREEMAN AREOLA MARKER**

- Ø = 34mm X 36mm **KI-90.34**
- Ø = 38mm X 42mm **KI-91.38**
- Ø = 42mm X 45mm **KI-92.42**
- Ø = 45mm X 50mm **KI-93.45**



**GROSSMANN AREOLA MARKER**  
**FOUR-RING AREOLA MARKER**  
 Aluminium Anodized

- KI-94.00**  
 Ø = 40 mm / Ø = 4 mm / Ø = 48 mm / 52mm



**FREEMAN AREOLA MARKER/Cutter**

- Ø = 34 mm **KI-94.34**
- Ø = 36 mm **KI-95.36**
- Ø = 38 mm **KI-96.38**
- Ø = 42 mm **KI-97.42**
- Ø = 45 mm **KI-98.45**
- Ø = 50 mm **KI-99.50**



**SOLZ AREOLA MARKER**

- Ø = 36 mm **KI -10.36**
- Ø = 40 mm **KI -11.40**
- Ø = 42 mm **KI -12.42**
- Ø = 45 mm **KI -13.45**

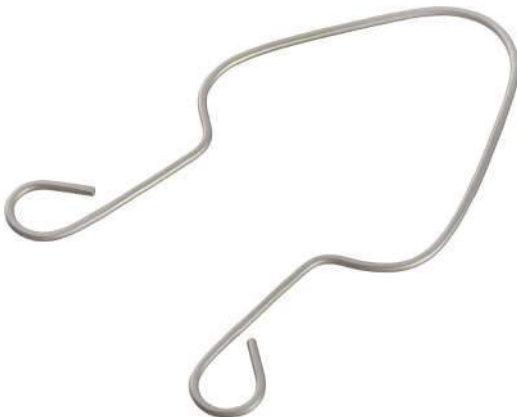

**KI-15.14** **Small**  
 14cm / 5 1/2"

**KI-16.16** **Large**  
 16cm / 6 1/4"



**MCKISOCK KEYHOLE PATTERN**

- Ø = 38 mm **KI-17.38**
- Ø = 42 mm **KI-18.42**
- Ø = 45 mm **KI-19.45**



**Walden Breast Marker 70mm, with 7cm**

KI-20.00

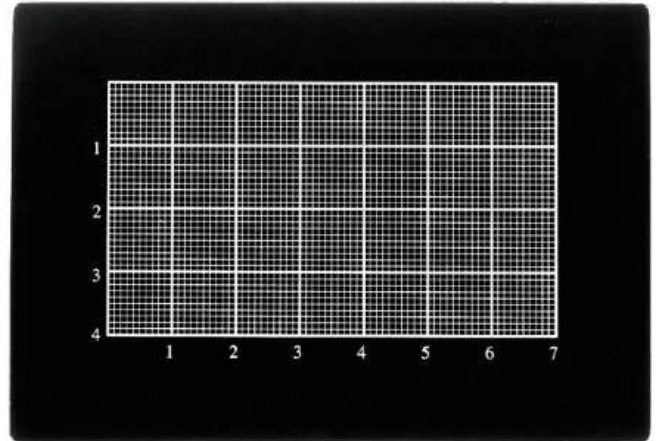

**Sheen Grid Reverse, Autoclavable**

KI-21.00



**Castroviejo Caliper, 7cm  
Measuring Range 20mm**

KI-22.00



**Castroviejo Caliper, 9cm  
Measuring Range 40mm**

KI-23.00



CASTROVIEJO EPKER  
**KI-24.42**  
 18 cm / 7 1/8"



CASTROVIEJO EPKER  
**KI-25.43**  
 18 cm / 7 1/8"



GUBISCH  
**KI-26.02**  
 Pen

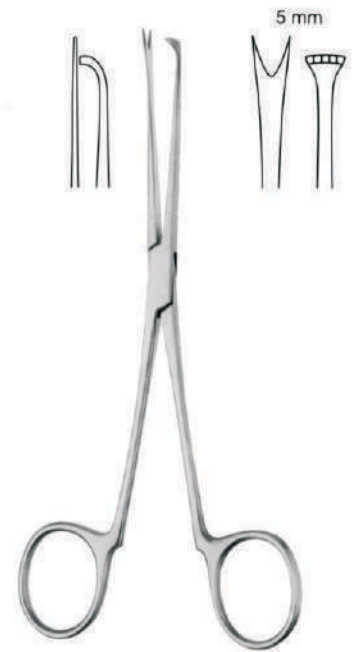

PITANGUY  
**KI-27.30**  
 16 cm / 6 1/4"



MARTEN FLAP MARKER  
**KI-28.14**  
 14.5 cm / 5 3/4"



D ASSUMPCAO ABDOMINAL FLAP  
 MARKER **KI-29.16**  
 10mm Width, 16cm



DeMartel Scalp Flap Demarcator  
**KI-30.30**  
 15 cm



**Thorpe Caliper, 80mm Measuring Range, 11cm**  
KI-31.30

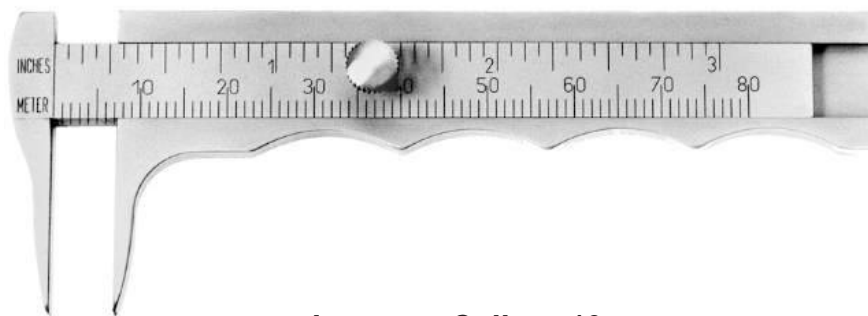

**Jameson Caliper 10cm**  
KI-32.30



**Ruler, Stainless Steel Graduation in Millimeter and Inches**

**KI-33-15**  
15 cm / 6"

**KI-34-20**  
20 cm / 8"

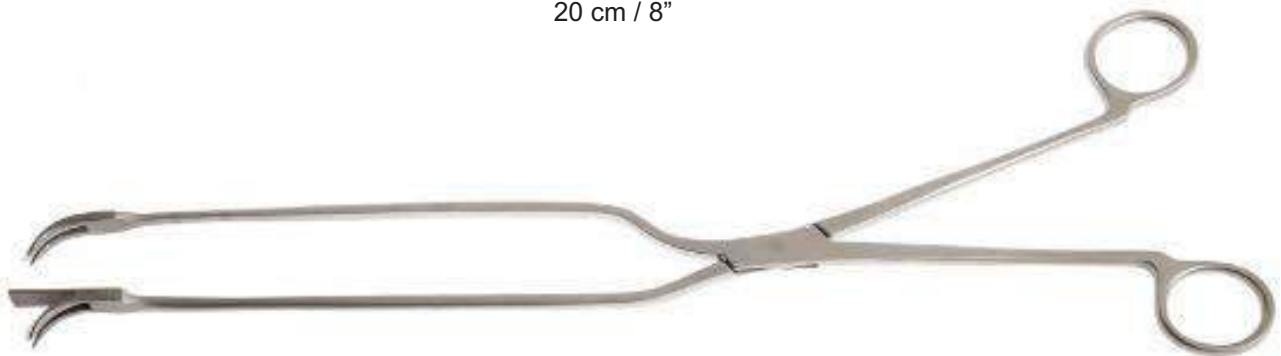

**LOCKWOOD ABDOMINAL FLAP DEMARCATOR**

**KI-35.32**  
11mm Width, 32cm



**KI-36-10**  
24 cm / 9½"



**JOSEPH**  
**KI-37-47**  
17 cm / 6¾"



**JOSEPH**

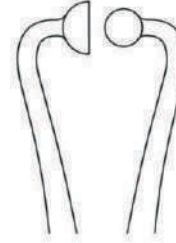

**KI-30.12**  
12 cm / 4¾"

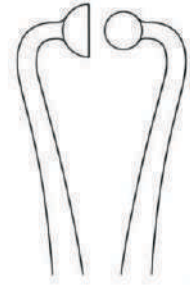

**KI-30.14**  
14.5 cm / 5¾"

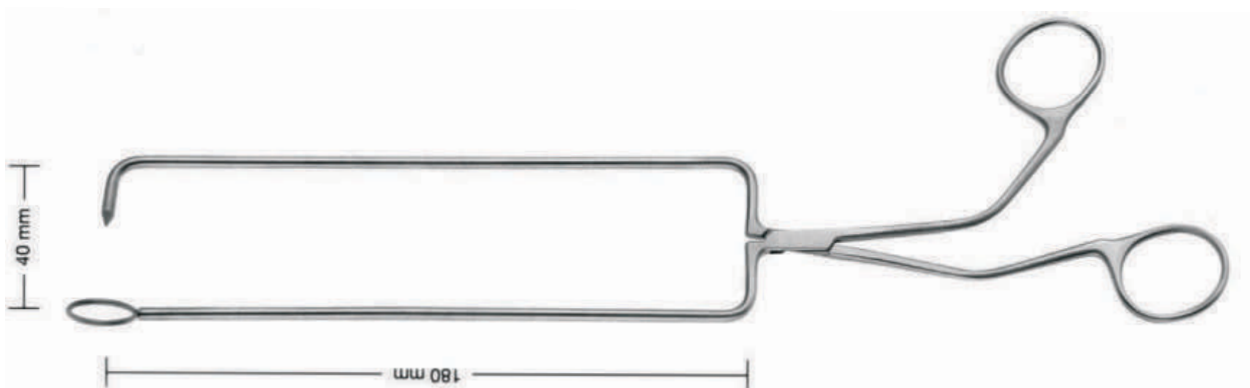

**SOLZ Navel Marker**  
**KI-40.53**

# SUCTION TUBES



"Supporting Healthcare"  
**KAAHA INDUSTRIES**  
 Manufacturer Of Dental & Surgical Instruments

6 mm



10 mm



6 mm



8 mm



POOLE  
**KI-54.18** – ø 6 mm  
**KI-55-30** – ø 10mm  
 22 cm / 8 3/4"



POOLE  
**KI-56.18** – ø 6 mm  
**KI-57-23** – ø 8 mm  
 22 cm / 8 3/4"



**KI-58.01** – 10 Fr (3.3mm)  
**KI-59.02** – 12 Fr (4.0mm)

*Frazier Suction Tube Insulated,  
 With Finger Cut Off, Angled*



YANKAUER  
**KI-60.00**  
 28 cm / 11"



FRAZIER

12.5 cm / 5"	18 cm / 7"		12.5 cm / 5"	18 cm / 7"
<b>KI-61.06</b>	<b>KI-65.52</b>	Charr 6	<b>KI-69.36</b>	<b>KI-73.86</b>
<b>KI-62.08</b>	<b>KI-66.58</b>	Charr 8	<b>KI-70.38</b>	<b>KI-74.88</b>
<b>KI-63.10</b>	<b>KI-67.60</b>	Charr 10	<b>KI-71.40</b>	<b>KI-75.90</b>
<b>KI-64.12</b>	<b>KI-68.62</b>	Charr 12	<b>KI-72.42</b>	<b>KI-76.92</b>

# SCISSORS



"Supporting Healthcare"  
**KAAHA INDUSTRIES**  
 Manufacturer Of Dental & Surgical Instruments



standard  
 supercut  
 TC  
 supercut plus

IRIS



9cm/3 1/2"  
**KI-40.09**



10.5cm/4 1/4"  
**KI-41.10**  
**KI-42.110**



11.5cm/4 1/2"  
**KI-43.11**  
**KI-44.111**  
**KI-45.61**  
**KI-46.161**



12.5cm/5"  
**KI-47.12**



supercut  
 TC  
 supercut plus

IRIS



straight  
 11.5 cm / 4 1/2"  
**KI-48.171**  
**KI-49.71**  
**KI-50.171**



curved  
 11.5 cm / 4 1/2"  
**KI-51.171**  
**KI-52.71**  
**KI-53.171**



standard  
 supercut

MICRO IRIS



straight  
 9 cm / 3 1/2"  
**KI-54.30**



curved  
 9 cm / 3 1/2"  
**KI-55.30**  
**KI-56.130**



standard  
 supercut  
 TC  
 supercut plus

IRIS



9 cm / 3 1/2"  
**KI-57.09**



10.5 cm / 4 1/8"  
**KI-58.10**  
**KI-59.110**



11.5 cm / 4 1/2"  
**KI-60.11**  
**KI-61.111**  
**KI-62.61**  
**KI-63.1**



12.5 cm / 5"  
**KI-64.12**  
**KI-65.112**



# SCISSORS



"Supporting Healthcare"  
**KAAHA INDUSTRIES**  
 Manufacturer Of Dental & Surgical Instruments



KNAPP

standard  
 supercut

12 cm / 4¾"  
**KI-66.32**  
**KI-67.132**



12 cm / 4¾"  
**KI-68.32**  
**KI-69.132**



12 cm / 4¾"  
**KI-70.52**



12 cm / 4¾"  
**KI-71.52**



KNAPP

10 cm / 4"  
 standard

**KI-72.70**



10 cm / 4"  
**KI-73.70**



standard

9.5cm / 5"  
**KI-74.90**



standard  
 supercut  
 TC

12.5cm / 5"  
**KI-75.42**  
**KI-76.142**  
**KI-77.62**



12.5cm / 5"  
**KI-78.43**  
**KI-79.143**  
**KI-80.63**



# SCISSORS



"Supporting Healthcare"  
**KAAHA INDUSTRIES**  
 Manufacturer Of Dental & Surgical Instruments



STEVENS

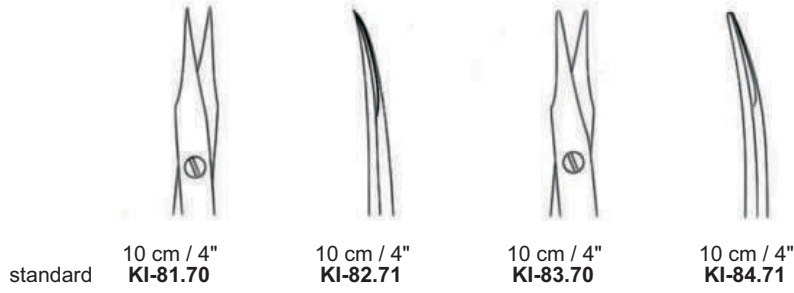

standard 10 cm / 4" KI-81.70 10 cm / 4" KI-82.71 10 cm / 4" KI-83.70 10 cm / 4" KI-84.71



STEVENS

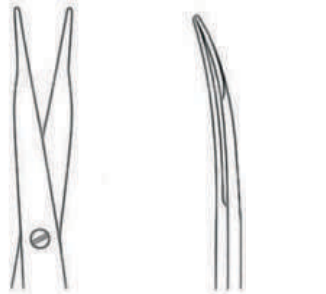

standard supercut 11.5 cm / 4 1/2" KI-85.12 KI-86.112 11.5 cm / 4 1/2" KI-87.13 KI-88.113



STEVENS

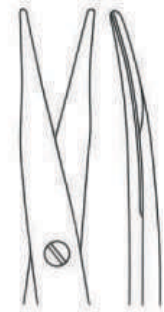

standard supercut 13 cm / 5 1/8" KI-89.15 KI-90.115



LEXER BABY

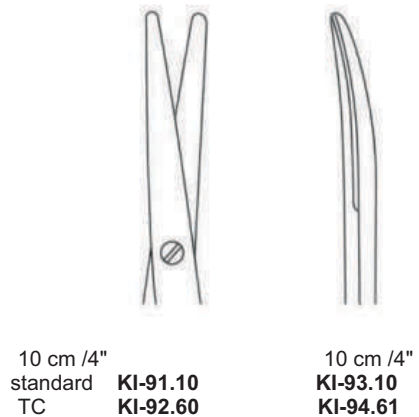

10 cm / 4" standard TC KI-91.10 KI-92.60 10 cm / 4" KI-93.10 KI-94.61



KNAPP

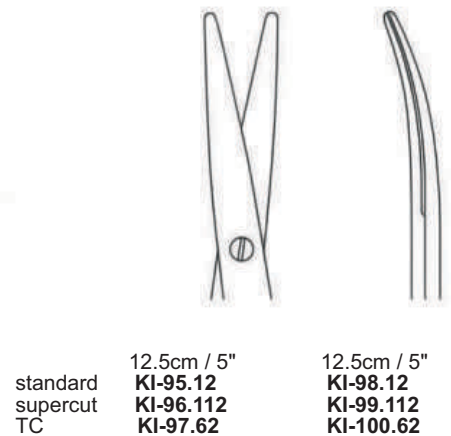

standard supercut TC 12.5cm / 5" KI-95.12 KI-96.112 KI-97.62 12.5cm / 5" KI-98.12 KI-99.112 KI-100.62

# SCISSORS



"Supporting Healthcare"  
**KAAHA INDUSTRIES**  
 Manufacturer Of Dental & Surgical Instruments



KELLY

standard  
 supercut  
 TC  
 supercut plus



16 cm / 6 1/4"  
**KI-101.16**  
**KI-102.116**  
**KI-103.66**  
**KI-104.166**



16 cm / 6 1/4"  
**KI-105.16**  
**KI-106.116**  
**KI-107.66**  
**KI-108.166**



16 cm / 6 1/4"  
 supercut **KI-109.116**



16 cm / 6 1/4"  
**KI-110.116**



BRUSER KELLY



standard  
 TC

11.5cm / 4 1/2"  
**KI-111.131**  
**KI-112.61**



11.5cm / 4 1/2"  
**KI-113.132**  
**KI-114.62**



SIEGERT



13 cm / 5 1/8"  
**KI-115.13**  
**KI-116.113**  
**KI-117.63**  
**KI-118.163**



15 cm / 6"  
**KI-119.15**  
**KI-120.115**  
**KI-121.65**  
**KI-122.165**



18 cm / 7 1/8"  
**KI-123.18**  
**KI-124.118**  
**KI-125.68**  
**KI-126.168**



20 cm / 8"  
**KI-127.20**



RAGNELL (KILNER)

standard  
 supercut  
 TC  
 supercut plus

# SCISSORS



"Supporting Healthcare"  
**KAAHA INDUSTRIES**  
 Manufacturer Of Dental & Surgical Instruments



GREENBERG KI



supercut  
 supercut plus  
 11.5 cm / 4½"  
**KI-128.122**  
**KI-129.122**



standard  
 supercut



11 cm / 4 3/8"  
**KI-130.11**  
**KI-131.111**



11 cm / 4 3/8"  
**KI-132.12**  
**KI-133.112**



JABELEY



standard  
 supercut  
 13 cm / 5 1/8"  
**KI-134.13**  
**KI-135.113**



13 cm / 5 1/8"  
**KI-136.14**  
**KI-137.114**



JOSEPH

standard  
 supercut



15cm / 6"  
**KI-138.14**  
**KI-139.114**



15cm / 6"  
**KI-140.14**  
**KI-141.114**

# SCISSORS



"Supporting Healthcare"  
**KAAHA INDUSTRIES**  
 Manufacturer Of Dental & Surgical Instruments



JAMESON

standard



15cm / 6"  
**KI-142.117**



18 cm / 7 1/8"  
**KI-143.118**



REYNOLDS (JAMESON)

standard



12 cm / 4 3/4"  
**KI-144.12**  
 blunt



14 cm / 5 1/2"  
**KI-145.14**  
 blunt



16 cm / 6 1/4"  
**KI-146.16**  
 blunt



18 cm / 7 1/8"  
**KI-147.18**  
 blunt



REYNOLDS (JAMESON)

standard  
 supercut



12 cm / 4 3/4"  
**KI-148.12**  
**KI-149.112**  
 blunt



14 cm / 5 1/2"  
**KI-150.14**



16 cm / 6 1/4"  
**KI-151.16**  
**KI-152.116**  
 blunt



18 cm / 7 1/8"  
**KI-153.18**  
**KI-154.118**  
 blunt

# SCISSORS



"Supporting Healthcare"  
**KAAHA INDUSTRIES**  
 Manufacturer Of Dental & Surgical Instruments



PECK JOSEPH

supercut

14 cm / 5½"  
**KI-155.134**

14 cm / 5½"  
**KI-156.134**

14 cm / 5½"  
**KI-157.144**

14 cm / 5½"  
**KI-158.144**



"slim"

standard  
 supercut  
 TC  
 supercut plus

14 cm / 5½"  
**KI-159.14**  
**KI-160.114**  
**KI-161.64**  
**KI-162.164**

18 cm / 7 1/8"  
**KI-163.18**

20 cm / 8"  
**KI-164.20**



"slim"

standard  
 supercut  
 TC  
 supercut plus

14 cm / 5½"  
**KI-165.14**  
**KI-166.114**  
**KI-167.64**  
**KI-168.164**

18 cm / 7 1/8"  
**KI-169.18**  
**KI-170.118**

20 cm / 8"  
**KI-171.20**



# SCISSORS



"Supporting Healthcare"  
**KAAHA INDUSTRIES**  
Manufacturer Of Dental & Surgical Instruments

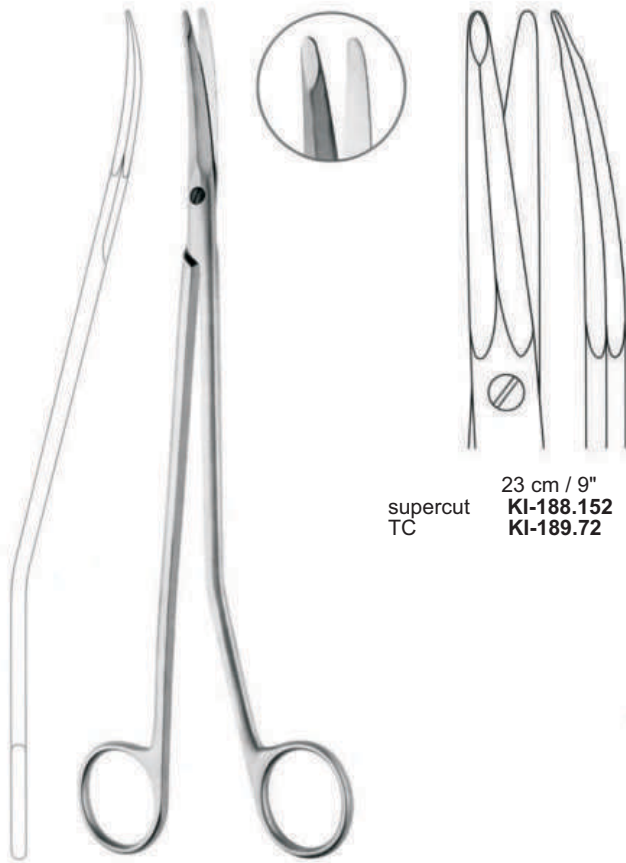

supercut  
TC  
23 cm / 9"  
**KI-188.152**  
**KI-189.72**

GORNEY-FREEMAN

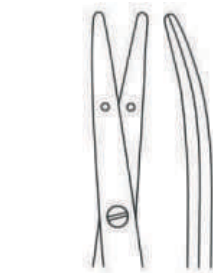

standard  
12 cm / 4¾"  
**KI-190.01**

GORNEY-FREEMAN



KAYE



supercut  
TC  
15 cm / 6"  
**KI-191.115**

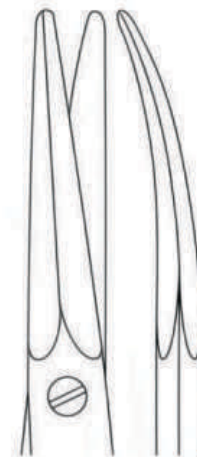

17cm / 6¾"  
**KI-192.117**  
**KI-193.37**



# SCISSORS



"Supporting Healthcare"  
**KAAHA INDUSTRIES**  
Manufacturer Of Dental & Surgical Instruments



KAYE

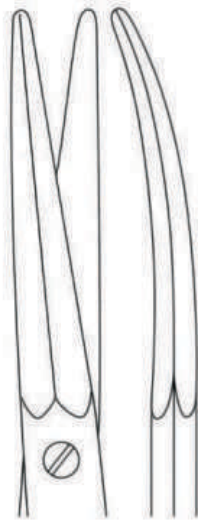

supercut  
TC  
19 cm / 7 1/2"  
KI-194.119  
KI-195.39



23 cm / 9"  
KI-196.123  
KI-197.43



KAYE



supercut  
11.5 cm / 4 1/2"  
KI-198.132



SOLZ

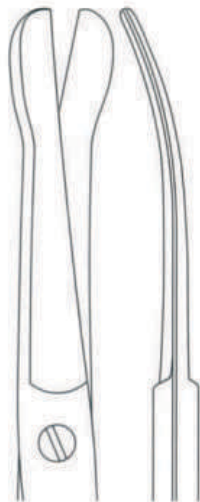

supercut  
20 cm / 8"  
KI-199.220



SOLZ

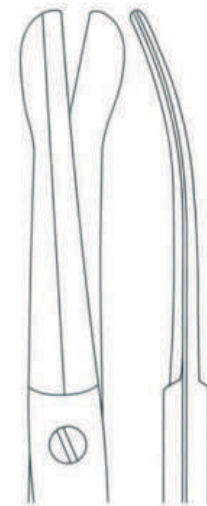

supercut  
20 cm / 8"  
KI-200.230



O'BRIEN



standard  
9 cm / 3½"  
KI-201.09



UNIVERSAL  
KI-202.12  
12 cm / 4¾"



RHINOPLASTY FINE SCISSORS



TC  
14.5cm / 5¾"  
KI-203.84



18 cm / 7¼"  
KI-204.88



23 cm / 9"  
KI-205.93

# SCISSORS



"Supporting Healthcare"  
**KAAHA INDUSTRIES**  
 Manufacturer Of Dental & Surgical Instruments



FOMON

standard  
 supercut  
 supercut plus



13 cm / 5 1/8"  
**KI-206.13**  
**KI-207.113**  
**KI-208.163**



WALTER

supercut



14 cm / 5 1/2"  
**KI-209.14**

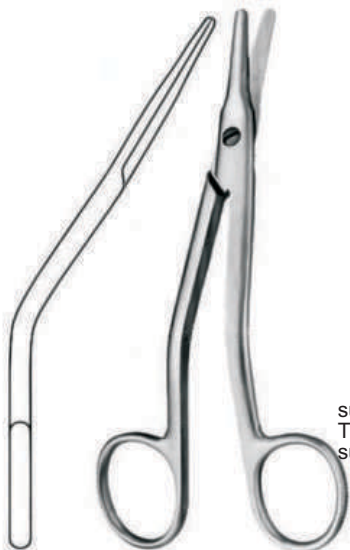

WALTER COTTLE

supercut  
 TC  
 supercut plus



16 cm / 6 1/4"  
**KI-210.16**  
**KI-211.77**  
**KI-212.177**



COTTLE

standard  
 supercut  
 TC  
 supercut plus

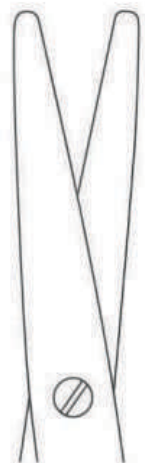

16cm / 6 1/4"  
**KI-213.16**  
**KI-214.116**  
**KI-215.36**  
**KI-216.136**

# SCISSORS



"Supporting Healthcare"  
**KAAHA INDUSTRIES**  
 Manufacturer Of Dental & Surgical Instruments



GIUNTA

TC

13.5 cm / 5 3/8"  
**KI-217.63**



CONVERSE

standard

13.5 cm / 5 3/8"  
**KI-218.13**



COTTLE MASING

10 cm / 4"  
 standard

**KI-219.10**



10 cm / 4"  
**KI-220.10**



COTTLE

standard

11.5 cm / 4 1/4"  
**KI-221.12**



CINELLI

standard

11 cm / 4 3/8"  
**KI-222.11**

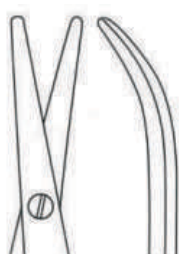

FOMON

standard

12.5 cm / 5"  
**KI-223.43**





DEAN

standard  
supercut

17 cm / 6<sup>3</sup>/<sub>4</sub>"  
**KI-224.17**  
**KI-225.117**



HEYMANN

standard  
20 cm / 8"



HEYMANN

standard  
supercut

17 cm / 6<sup>3</sup>/<sub>4</sub>"  
**KI-227.17**

17 cm / 6<sup>3</sup>/<sub>4</sub>"  
**KI-228.21**

18 cm / 7 1/8"  
**KI-229.122**



# SCISSORS



"Supporting Healthcare"  
**KAAHA INDUSTRIES**  
 Manufacturer Of Dental & Surgical Instruments



FOX

standard  
 supercut  
 TC  
 supercut plus



13 cm / 5 1/8"  
**KI-230.13**  
**KI-231.113**  
**KI-232.63**  
**KI-233.163**



13 cm / 5 1/8"  
**KI-234.13**  
**KI-235.113**  
**KI-236.63**  
**KI-237.163**



SPENCER

standard  
 TC

9 cm / 3 1/2"  
**KI-238.09**



10.5 cm / 4 1/8"  
**KI-239.10**  
**KI-240.60**



12 cm / 4 3/4"  
**KI-241.12**  
**KI-242.62**



LITTAUER



standard  
 13 cm / 5 1/8"  
**KI-243.13**



KELLY



standard  
 15 cm / 6"  
**KI-244.35**

# SCISSORS



"Supporting Healthcare"  
**KAAHA INDUSTRIES**  
 Manufacturer Of Dental & Surgical Instruments



MCINDOE



standard 19 cm / 7½"  
**KI-245.18**



AUFRICHT

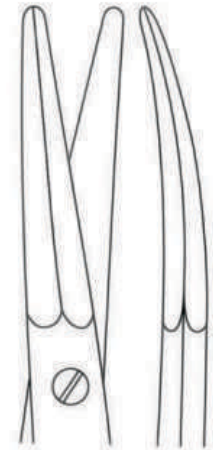

standard  
 supercut  
 TC  
 supercut plus

14 cm / 5½"  
**KI-246.34**  
**KI-247.134**  
**KI-248.64**  
**KI-249.164**



FOMON



standard 12.5 cm / 5"  
**KI-250.43**



FANOUS



standard  
 supercut

13 cm / 5 1/8"  
**KI-251.14**  
**KI-252.114**

# SCISSORS



"Supporting Healthcare"  
**KAAHA INDUSTRIES**  
Manufacturer Of Dental & Surgical Instruments

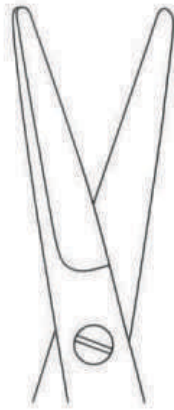
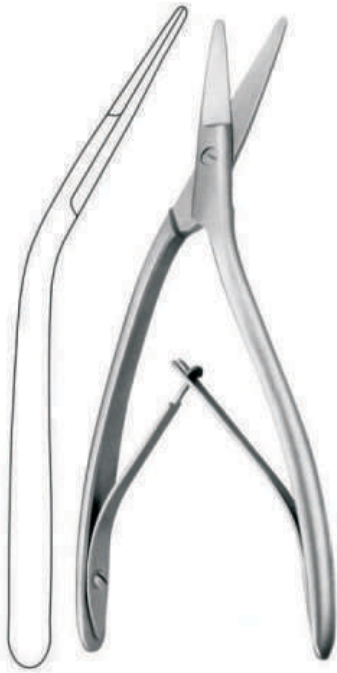

**COTTLE**  
**KI-253.19**  
18 cm / 7 1/8"

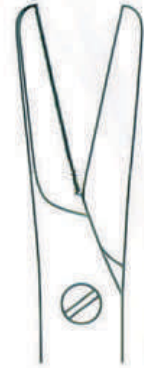
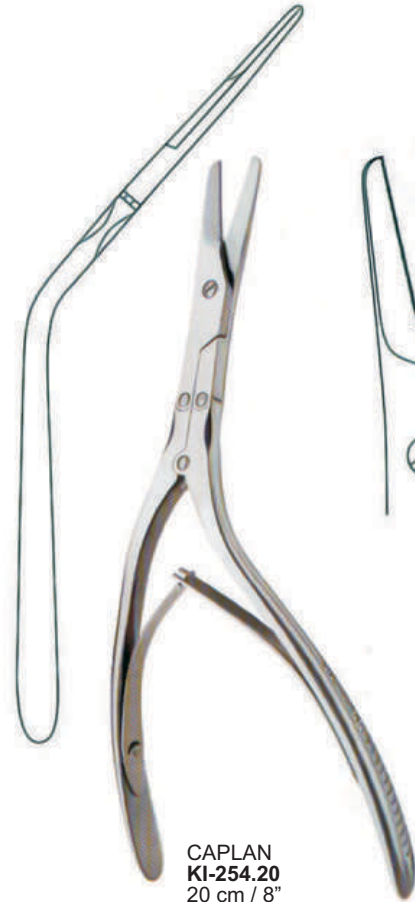

**CAPLAN**  
**KI-254.20**  
20 cm / 8"



21cm / 8 1/4"  
**KI-255.31**



21cm / 8 1/4"  
**KI-256.32**



21cm / 8 1/4"  
**KI-257.33**

**OBWEGESER**



# SCISSORS



"Supporting Healthcare"  
**KAAHA INDUSTRIES**  
Manufacturer Of Dental & Surgical Instruments

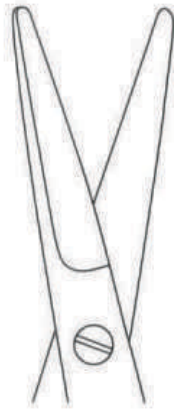

COTTLE  
KI-253.19  
18 cm / 7 1/8"

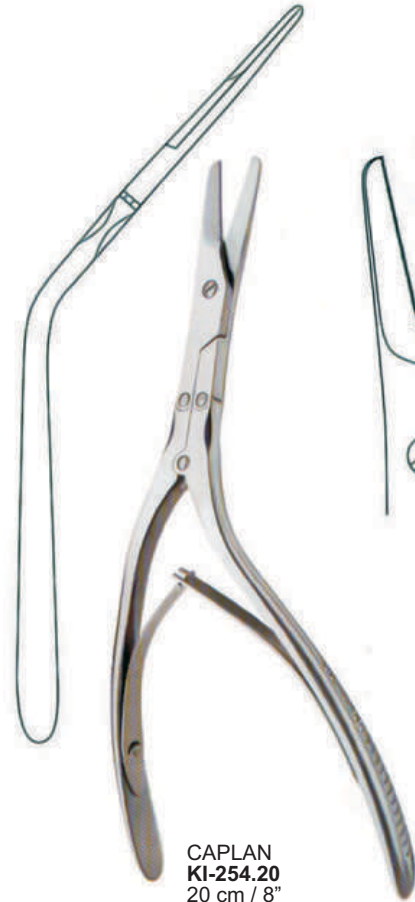

CAPLAN  
KI-254.20  
20 cm / 8"



21cm / 8 1/4"  
KI-255.31



21cm / 8 1/4"  
KI-256.32



21cm / 8 1/4"  
KI-257.33

OBWEGESER

# SCISSORS



"Supporting Healthcare"  
**KAAHA INDUSTRIES**  
 Manufacturer Of Dental & Surgical Instruments



MAYO LEXER

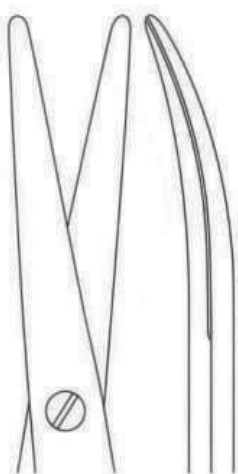

supercut  
 TC  
 supercut plus

16.5 cm / 6½"  
**KI-282.187**  
**KI-283.97**  
**KI-284.197**



LEXER



standard  
 supercut  
 TC  
 supercut plus

16 cm / 6¼"  
**KI-285.86**  
**KI-286.116**  
**KI-287.96**  
**KI-288.196**

16 cm / 6¼"  
**KI-289.17**  
**KI-290.117**  
**KI-291.96**  
**KI-292.16**



BABY METZENBAUM

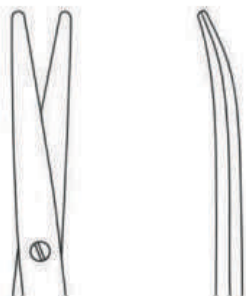

standard  
 supercut  
 TC  
 supercut plus

11.5 cm / 4½"  
**KI-296.11**  
**KI-297.111**  
**KI-298.61**  
**KI-299.161**

11.5 cm / 4½"  
**KI-300.11**  
**KI-301.111**  
**KI-302.61**  
**KI-303.161**



**KI-293.30**  
 16 cm

**KI-294.30**  
 18 cm

**KI-295.30**  
 23 cm

**Trepstat Facial Flap Dissector Scissors**  
**T.C. insert**

# SCISSORS



"Supporting Healthcare"  
**KAAHA INDUSTRIES**  
 Manufacturer Of Dental & Surgical Instruments



METZENBAUM

standard  
 supercut  
 TC  
 supercut plus



14 cm / 5½"  
**KI-304.14**  
**KI-305.114**  
**KI-306.64**  
**KI-307.164**



18 cm / 7 1/8"  
**KI-308.18**  
**KI-309.118**  
**KI-310.68**  
**KI-311.168**



20 cm / 8"  
**KI-312.20**  
**KI-313.120**  
**KI-314.70**  
**KI-315.170**



BABY METZENBAUM

standard  
 supercut  
 TC  
 supercut plus



14 cm / 5½"  
**KI-316.14**  
**KI-317.114**  
**KI-318.64**  
**KI-319.164**



15 cm / 6"  
**KI-320.15**  
**KI-321.115**  
**KI-322.68**  
**KI-323.168**



18 cm / 7 1/8"  
**KI-324.18**  
**KI-325.118**  
**KI-326.70**  
**KI-327.170**



20 cm / 8"  
**KI-328.20**  
**KI-329.120**



MINI METZENBAUM

9 cm / 3½"  
 supercut **KI-330.109**



9 cm / 3½"  
**KI-331.109**



NELSON METZENBAUM

standard  
 supercut  
 TC  
 supercut plus



23 cm / 9"  
**KI-332.23**  
**KI-333.123**  
**KI-334.73**  
**KI-335.173**



26 cm / 10¼"  
**KI-336.26**  
**KI-337.126**



30 cm / 11¾"  
**KI-338.30**  
**KI-339.130**

# SCISSORS



"Supporting Healthcare"  
**KAAHA INDUSTRIES**  
 Manufacturer Of Dental & Surgical Instruments



NELSON METZENBAUM

standard  
 supercut  
 TC  
 supercut plus

23 cm / 9"  
**KI-340.23**  
**KI-341.123**  
**KI-342.73**  
**KI-343.173**

26 cm / 10¼"  
**KI-344.26**  
**KI-345.126**  
**KI-346.76**  
**KI-347.176**

30 cm / 11¾"  
**KI-348.30**  
**KI-349.130**  
**KI-350.80**  
**KI-351.180**



METZENBAUM slim

standard  
 supercut  
 TC  
 supercut plus

14 cm / 5½"  
**KI-352.14**  
**KI-353.114**  
**KI-354.64**  
**KI-355.164**

18 cm / 7 1/8"  
**KI-356.18**  
**KI-357.118**  
**KI-358.68**  
**KI-359.168**

20 cm / 8"  
**KI-360.20**  
**KI-361.120**  
**KI-362.70**  
**KI-363.170**

23 cm / 9"  
**KI-364.23**  
**KI-365.123**  
**KI-366.73**  
**KI-367.173**



# SCISSORS



"Supporting Healthcare"  
**KAAHA INDUSTRIES**  
 Manufacturer Of Dental & Surgical Instruments



METZENBAUM

supercut  
 TC  
 supercut plus



18 cm / 7 1/8"  
**KI-390.168**  
**KI-391.78**  
**KI-392.178**



20 cm / 8"  
**KI-393.170**  
**KI-394.80**  
**KI-395.180**

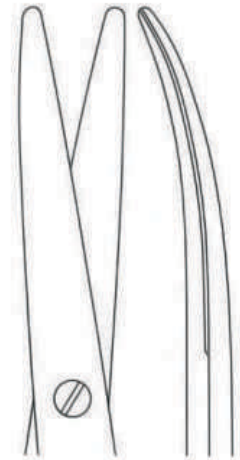

23 cm / 9"  
**KI-396.173**  
**KI-397.83**  
**KI-398.183**



METZENBAUM FREEMAN

supercut



18 cm / 7 1/8"  
**KI-399.168**

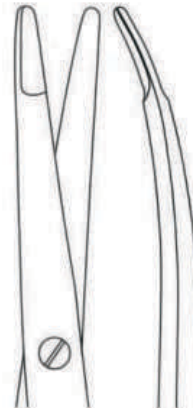

20 cm / 8"  
**KI-400.170**

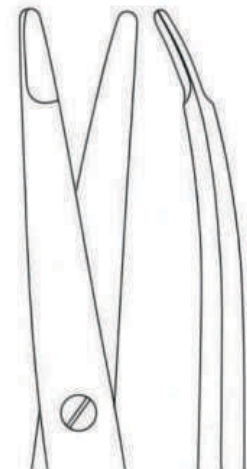

23 cm / 9"  
**KI-401.173**

# SCISSORS



"Supporting Healthcare"  
**KAAHA INDUSTRIES**  
 Manufacturer Of Dental & Surgical Instruments



standard

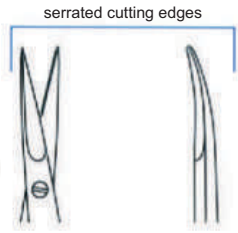

15 cm / 6"  
**KI-402.22**

15 cm / 6"  
**KI-403.23**

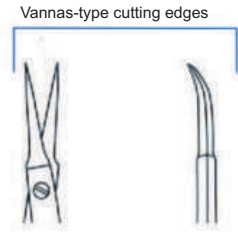

15 cm / 6"  
**KI-404.30**

15 cm / 6"  
**KI-405.31**

micro 2000



micro 2000

15 cm / 6"  
 standard  
 supercut



**KI-406.20**  
**KI-407.120**



15 cm / 6"  
**KI-408.21**  
**KI-409.121**

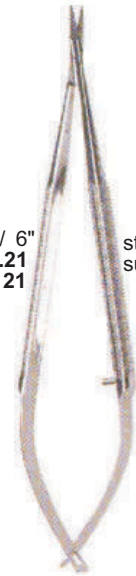

standard  
 supercut



15 cm / 6"  
**KI-410.74**  
**KI-411.174**



15 cm / 6"  
**KI-412.75**

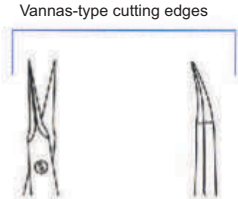

15 cm / 6"  
**KI-413.76**



15 cm / 6"  
**KI-414.77**

Round handle



standard



18 cm / 7¼"  
**KI-415.20**



18 cm / 7¼"  
**KI-416.21**



18 cm / 7¼"  
**KI-417.25**



18 cm / 7¼"  
**KI-418.26**



standard

23 cm / 9"  
**KI-419.02**



Round handle



# SCISSORS



"Supporting Healthcare"  
**KAAHA INDUSTRIES**  
 Manufacturer Of Dental & Surgical Instruments



standard

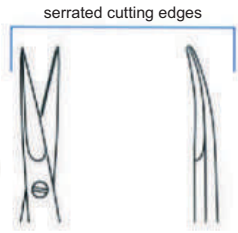

serrated cutting edges

15 cm / 6"  
**KI-402.22**

15 cm / 6"  
**KI-403.23**

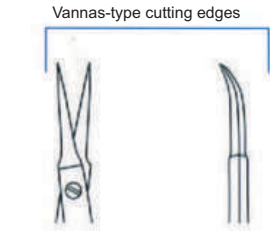

Vannas-type cutting edges

15 cm / 6"  
**KI-404.30**

15 cm / 6"  
**KI-405.31**

micro 2000



micro 2000

15 cm / 6"  
 standard  
 supercut



**KI-406.20**  
**KI-407.120**



15 cm / 6"  
**KI-408.21**  
**KI-409.121**

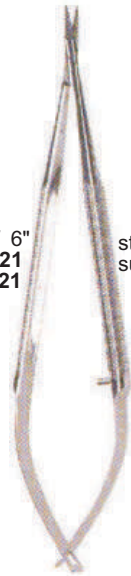

standard  
 supercut



15 cm / 6"  
**KI-410.74**  
**KI-411.174**



15 cm / 6"  
**KI-412.75**

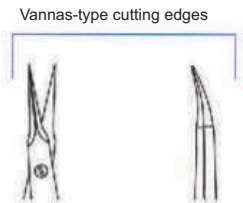

Vannas-type cutting edges

15 cm / 6"  
**KI-413.76**

15 cm / 6"  
**KI-414.77**

Round handle



standard 23 cm / 9"  
**KI-419.02**



standard



18 cm / 7¼"  
**KI-415.20**



18 cm / 7¼"  
**KI-416.21**



45°

18 cm / 7¼"  
**KI-417.25**



45°

18 cm / 7¼"  
**KI-418.26**



Round handle





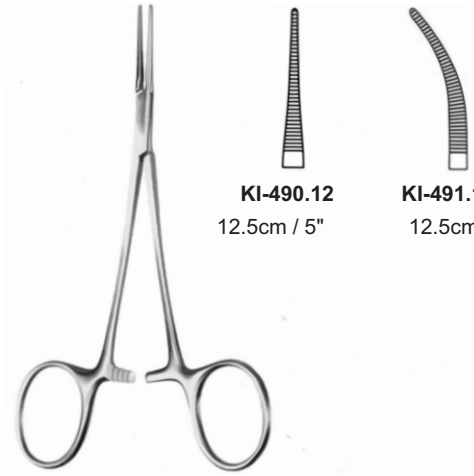

**KI-490.12**  
12.5cm / 5"

**KI-491.12**  
12.5cm / 5"

**MICRO MOSQUITO FORCECKI**

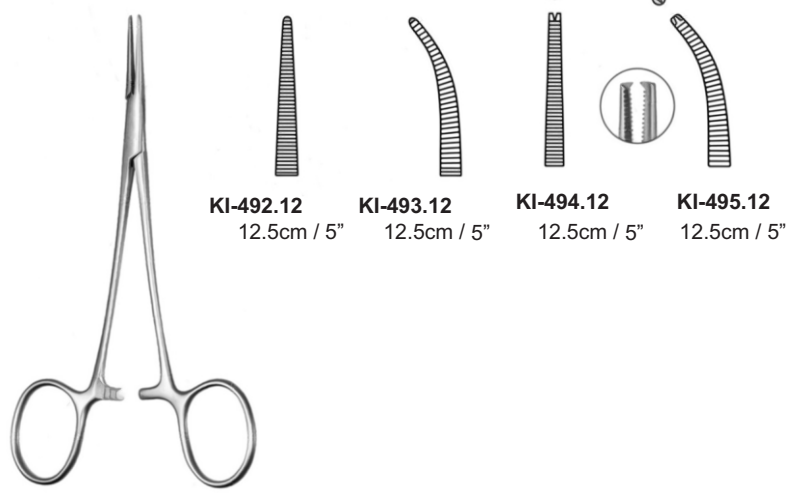

**KI-492.12**  
12.5cm / 5"

**KI-493.12**  
12.5cm / 5"

**KI-494.12**  
12.5cm / 5"

**KI-495.12**  
12.5cm / 5"

**HALSTED MOSQUITO FORCECKI**

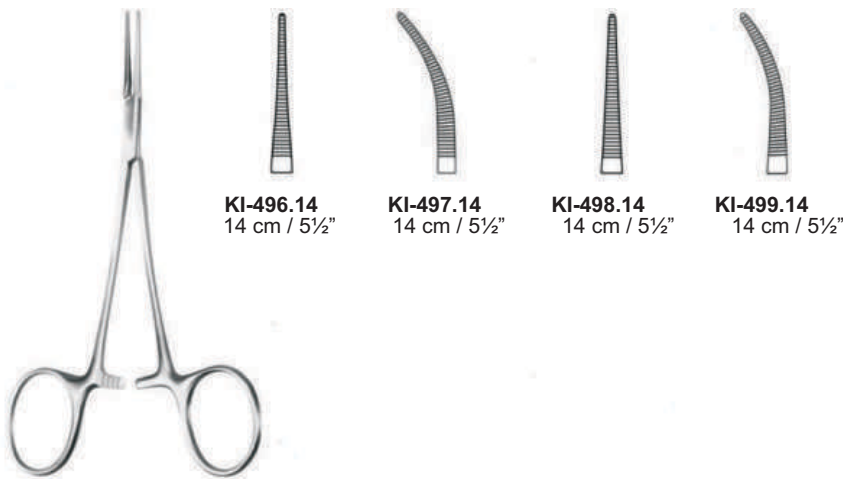

**KI-496.14**  
14 cm / 5½"

**KI-497.14**  
14 cm / 5½"

**KI-498.14**  
14 cm / 5½"

**KI-499.14**  
14 cm / 5½"

**MICRO MOSQUITO FORCECKI**

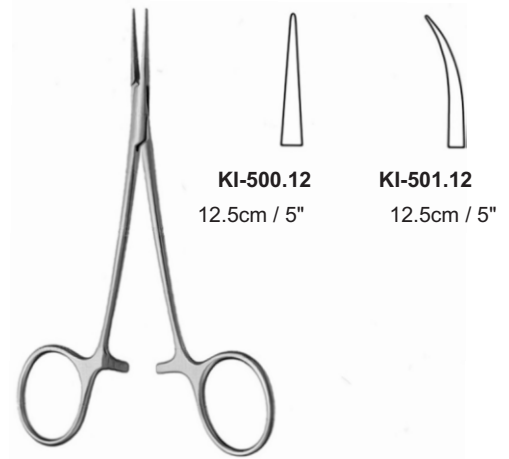

**KI-500.12**  
12.5cm / 5"

**KI-501.12**  
12.5cm / 5"

**MICRO JACOBSON FORCECKI**



DIETHRICH

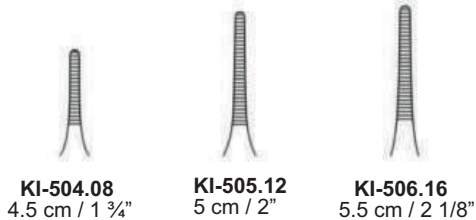

DIETHRICH

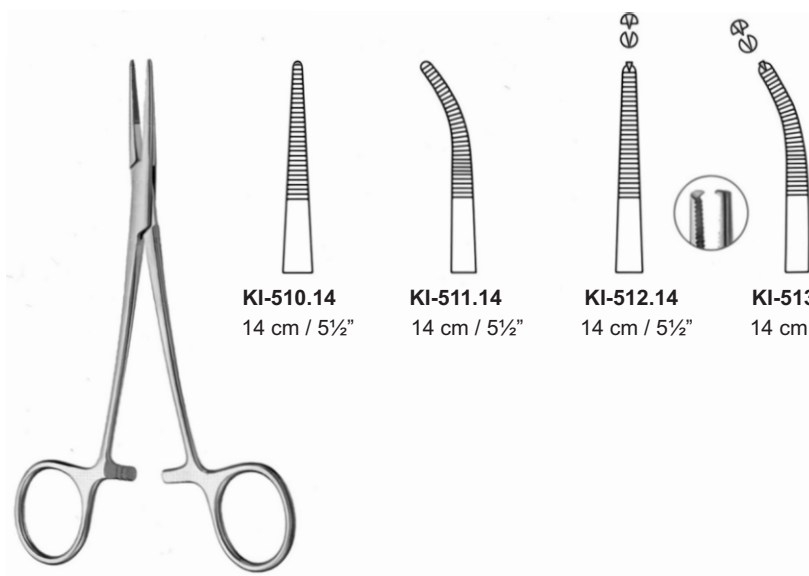
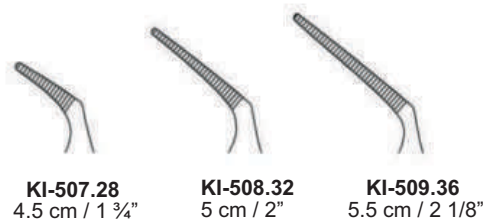

PROVIDENCE HOSPITAL FORCECKI, 14cm/5 1/2"

Atraumatic Serration



**KI-514.12**  
12.5cm / 5"



**KI-515.12**  
12.5cm / 5"

5 x 6



**KI-521-16**  
15 cm/ 6"

**KI-522-19**  
19 cm/ 7 1/2"

**KI-523-23**  
23 cm/ 9"



**Allis Tissue Grasping Forceps**

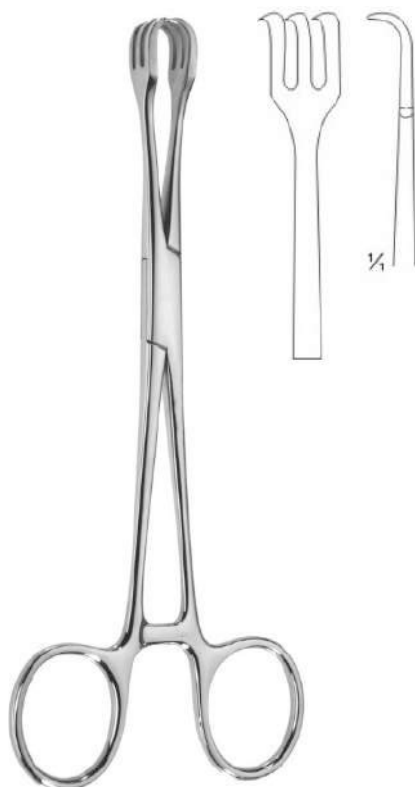

1/4

**Lahey Traction Forceps, 16cm**

**KI-516.16**



**CRILE**  
14,0 cm, 5 1/2"



**KI-524-14**



**KI-525-14**

1 x 2



**KI-526-14**

1 x 2



**KI-527-14**

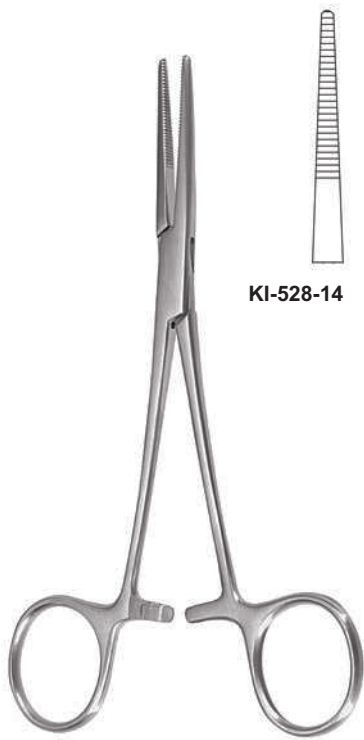

KI-528-14

**KELLY**  
 14,0 cm, 5½"



KI-528-114



**Gross Dressing Forceps With Box & Lock, 20cm**  
 KI-517.20



**ROCHESTER-PEAN**

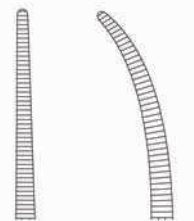

14,0 cm, 5½"	<b>KI-529-14</b>	<b>KI-537-14</b>
16,0 cm, 6¼"	<b>KI-530-16</b>	<b>KI-538-16</b>
18,0 cm, 7"	<b>KI-531-18</b>	<b>KI-539-18</b>
20,0 cm, 8"	<b>KI-532-20</b>	<b>KI-540-20</b>
22,0 cm, 8⅝"	<b>KI-533-22</b>	<b>KI-541-22</b>
24,0 cm, 9½"	<b>KI-534-24</b>	<b>KI-542-24</b>
26,0 cm, 10¼"	<b>KI-535-26</b>	<b>KI-535-26</b>

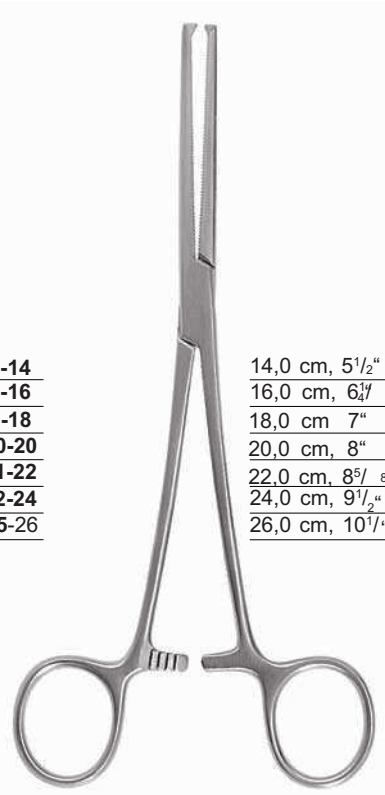

**KOCHER-OCHSNER**

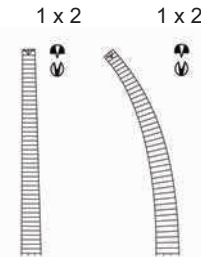

14,0 cm, 5½"	<b>KI-545-14</b>	<b>KI-552-14</b>
16,0 cm, 6¼"	<b>KI-546-16</b>	<b>KI-553-16</b>
18,0 cm, 7"	<b>KI-547-18</b>	<b>KI-554-18</b>
20,0 cm, 8"	<b>KI-548-20</b>	<b>KI-555-20</b>
22,0 cm, 8⅝"	<b>KI-549-22</b>	<b>KI-556-22</b>
24,0 cm, 9½"	<b>KI-550-24</b>	<b>KI-557-24</b>
26,0 cm, 10¼"	<b>KI-551-26</b>	<b>KI-558-26</b>



**BACKHAUS**

- 9,0 cm, 3 1/2" **KI-800-09**
- 11,0 cm, 4 3/8" **KI-801-11**
- 13,0 cm, 5" **KI-802-13**
- 15,0 cm, 6" **KI-803-15**



Edna Lorna  
Towel Clamp

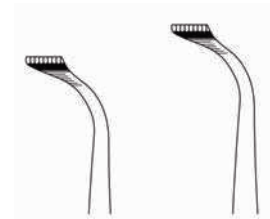

10,0 cm, 4" **KI-804-10**      13,0 cm, 5" **KI-805-13**

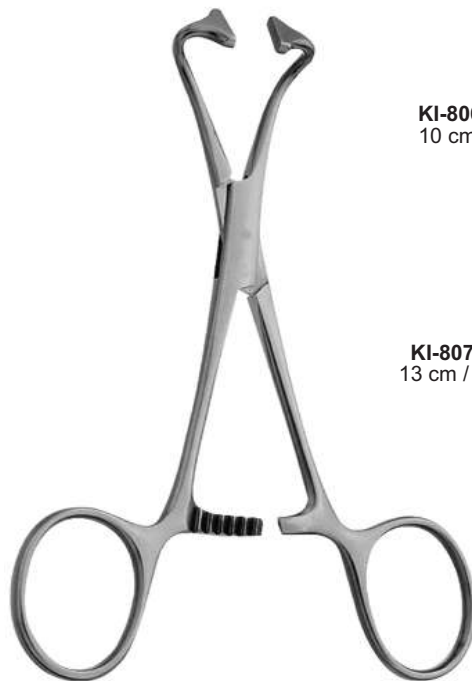

Non-Perforating Towel  
Clamp Forceps

**KI-806.10**  
10 cm / 4"

**KI-807.13**  
13 cm / 5 1/8"



Jones Towel Clamp,  
Cross Action

**KI-808.09**  
10 cm / 4"

# NEEDLE HOLDERS



"Supporting Healthcare"  
**KAAHA INDUSTRIES**  
Manufacturer Of Dental & Surgical Instruments



**COLLIER**  
**KI-09.13**  
13 cm / 5 1/8"

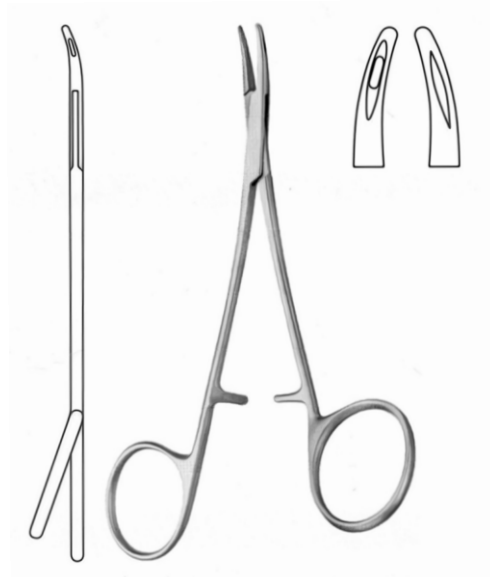

**CONVERSE**  
**KI-10.15**  
15 cm / 6"

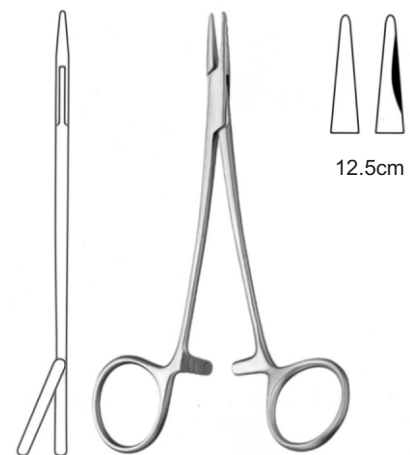

12.5cm

**KI-11.13**



12.5cm

**WRIGHT (DERF)**  
**KI-12.12**



12.5cm

**HALSEY**  
**KI-13.13**

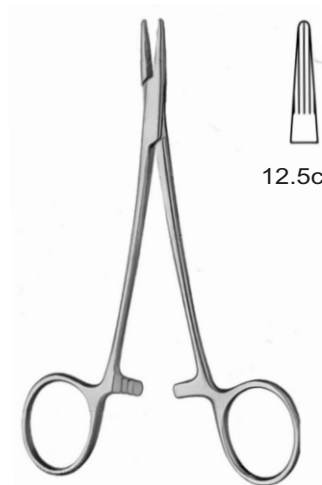

12.5cm

**DERF CONVERSE**  
**KI-14.82**



CRILE WOOD



**KI-15.15**  
15 cm / 6"



**KI-16.18**  
18 cm / 7 1/8"



**KI-17.20**  
20 cm / 8"



**KI-18.23**  
23 cm / 9"



**KI-20.15**  
15 cm / 6"



**KI-20.18**  
18 cm / 7 1/8"



**KI-20.20**  
20 cm / 8"



**KI-20.24**  
24 cm / 9 1/2"



**KI-20.30**  
30 cm / 11 3/4"

# NEEDLE HOLDERS



"Supporting Healthcare"  
**KAAHA INDUSTRIES**  
 Manufacturer Of Dental & Surgical Instruments



SENNING  
 KI-21.17

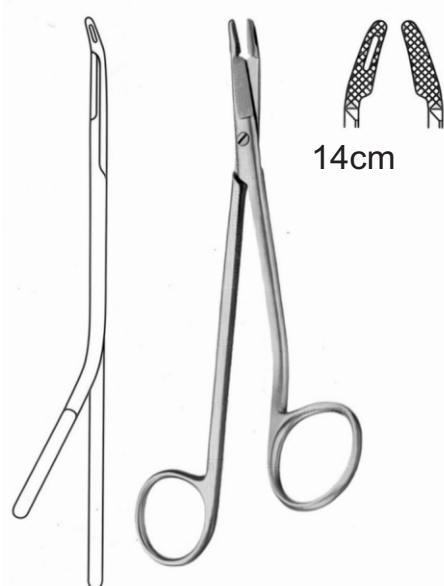

GILLIES SLIM  
 KI-22.14

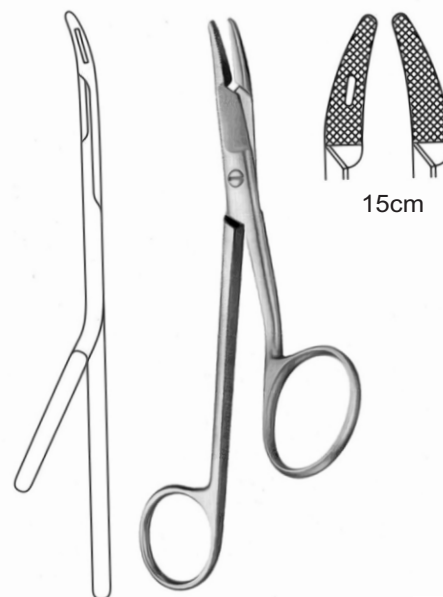

GILLIES  
 KI-23.15

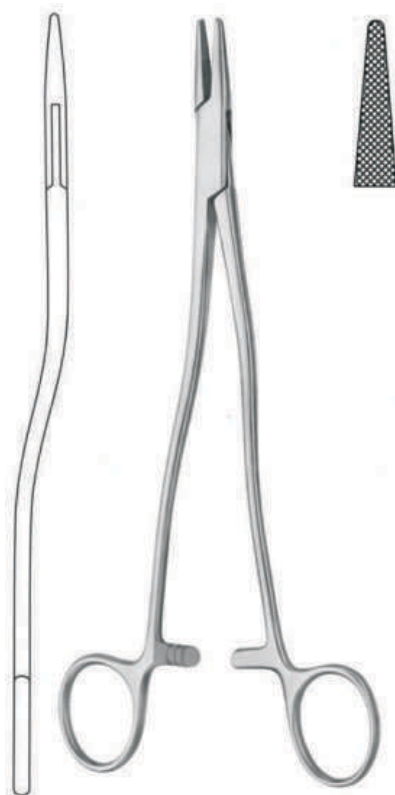

THOMSON WALKER  
 (BOZEMANN)  
 KI-24.20  
 20 cm / 8"



OLSEN-HEGAR  
 17,0 cm, 6<sup>3</sup>/<sub>4</sub>  
 KI-300.17

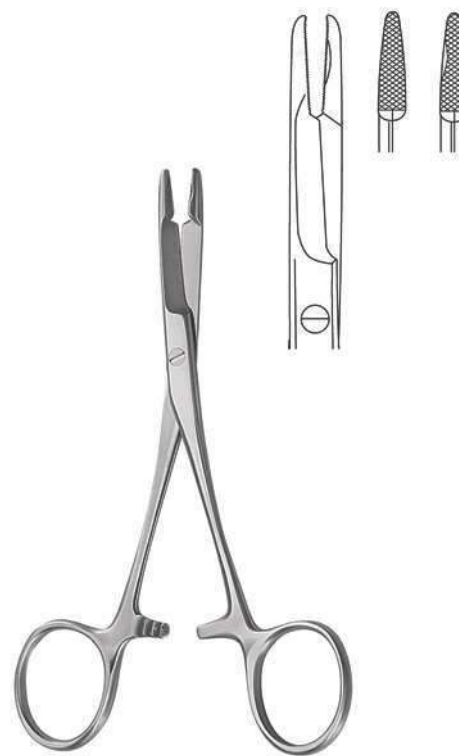

OLSEN-HEGAR  
 14,0 cm, 5<sup>1</sup>/<sub>2</sub>  
 KI-301.14



# NEEDLE HOLDERS



"Supporting Healthcare"  
**KAAHA INDUSTRIES**  
 Manufacturer Of Dental & Surgical Instruments



**KI-25-14**  
 14,0 cm, 5½"



**KI-26-17**  
 17,0 cm, 6¾"



**KI-27-20**  
 20,0 cm, 8"



**KI-28-10**



**KI-29-10**



MATHIEU-KOCHER

BARRAQUER-TROUTMAN  
 10,0 cm, 4"



**KI-30-10**



**KI-31-10**



BARRAQUER



**BARRAQUER**  
 13,5 cm, 5⅜"  
**KI-32-13**



**GOMEL**  
 14,0 cm, 5½"  
**KI-33-14**

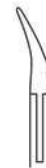

# NEEDLE HOLDERS



"Supporting Healthcare"  
**KAAHA INDUSTRIES**  
 Manufacturer Of Dental & Surgical Instruments



KI -34-18      KI -35-18

ohne Sperre  
 without ratchet  
 sin cremallera  
 senza cremagliera

18,5 cm, 7<sup>1</sup>/<sub>4</sub>"



KI -36-18      KI -37-18

mit Sperre  
 with ratchet  
 con cremallera  
 con cremagliera

18,5 cm, 7<sup>1</sup>/<sub>4</sub>"

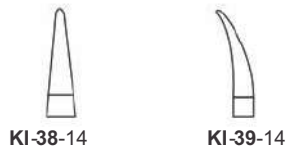

KI -38-14      KI -39-14

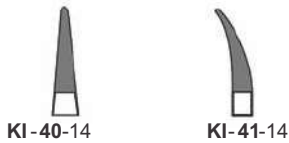

KI -40-14      KI -41-14

mit Sperre  
 with ratchet  
 con cremallera  
 con cremagliera

CASTROVIEJO  
 14,5 cm, 5<sup>3</sup>/<sub>4</sub>"

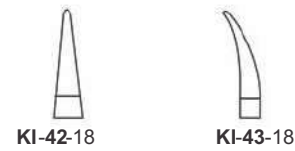

KI -42-18      KI -43-18

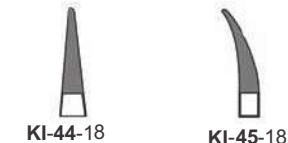

KI -44-18      KI -45-18

mit Sperre  
 with ratchet  
 con cremallera  
 con cremagliera

CASTROVIEJO  
 18,0 cm, 7"

0,4 mm



gerade, ohne Sperre  
 straight, without ratchet  
 recta, sin cremallera  
 retta, senza cremagliera

14,0 cm, 5 1/2"  
**KI-46-14**

0,4 mm



gebogen, ohne Sperre  
 curved, without ratchet  
 curva, sin cremallera  
 curva, senza cremagliera

14,0 cm, 5 1/2"  
**KI-47-14**

0,4 mm



14,0 cm, 5 1/2"  
**KI-48-14**

0,5 mm



gebogen, ohne Sperre  
 curved, without ratchet  
 curva, sin cremallera  
 curva, senza cremagliera

Ø 10 mm

14,0 cm, 5 1/2"  
**KI-49-14**

0,5 mm



gebogen, ohne Sperre  
 curved, without ratchet  
 curva, sin cremallera  
 curva, senza cremagliera

Ø 10 mm

14,0 cm, 5 1/2"  
**KI-50-14**

0,4 mm



gebogen, ohne Sperre  
 curved, without ratchet  
 curva, sin cremallera  
 curva, senza cremagliera

Ø 8 mm

13,0 cm, 5"  
**KI-51-13**

0,4 mm



gebogen, ohne Sperre  
 curved, without ratchet  
 curva, sin cremallera  
 curva, senza cremagliera

Ø 8 mm

13,0 cm, 5"  
**KI-52-13**

# NEEDLE HOLDERS



"Supporting Healthcare"  
**KAAHA INDUSTRIES**  
 Manufacturer Of Dental & Surgical Instruments

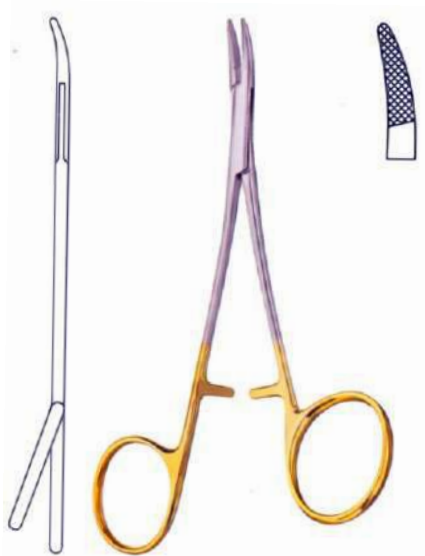

CONVERSE  
**KI-53.65**  
 15 cm / 6"



**KI-54.61**  
 11.5 cm / 4½"

NAGATA

**KI-55.63**  
 13 cm / 5 1/8"



NEIVERT  
**KI-56.62**

12.5cm



GUBISCH  
**KI-57.61**

12.5cm



HALSEY  
**KI-58.63**

13cm



HEGAR-BAUMGARTNER

**KI-59-12**  
 12,5 cm, 5"

**KI-60-14**  
 14,0 cm, 5½"

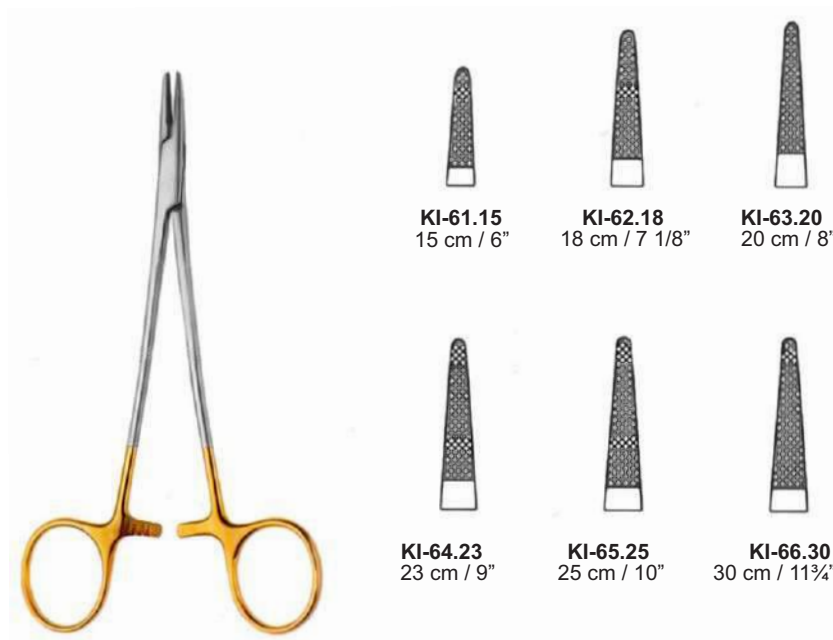

CRILE WOOD

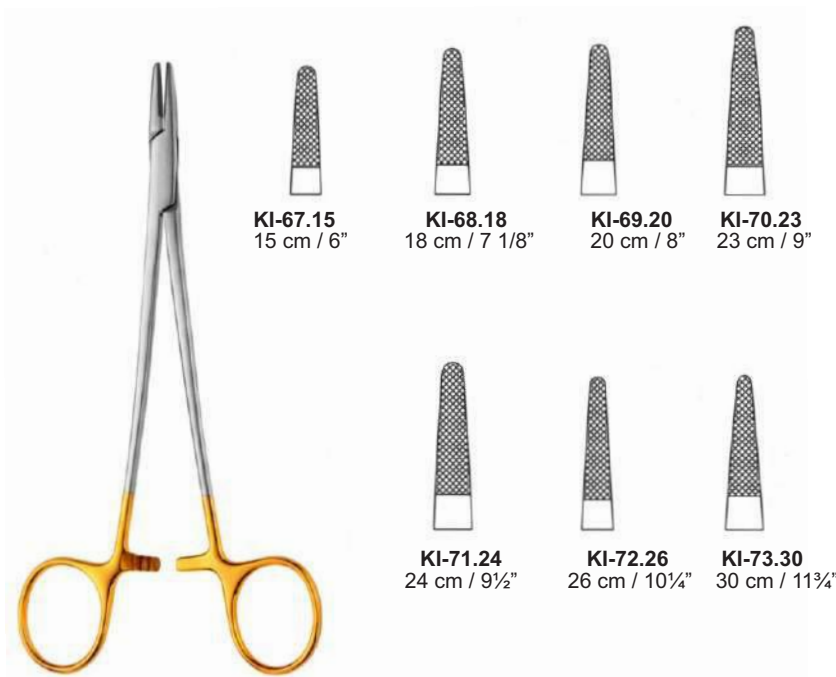

MAYO HEGAR

# NEEDLE HOLDERS



"Supporting Healthcare"  
**KAAHA INDUSTRIES**  
 Manufacturer Of Dental & Surgical Instruments

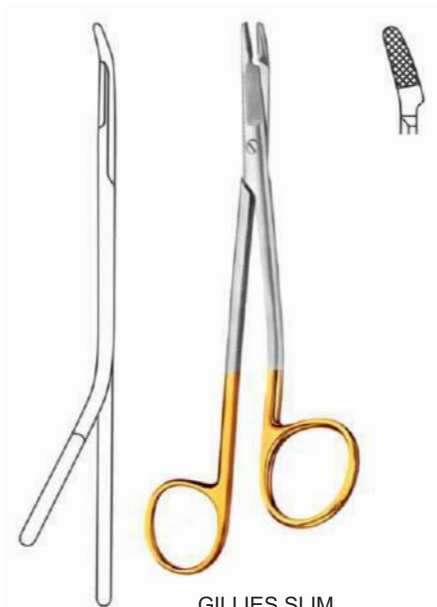

GILLIES SLIM  
 KI-74.15

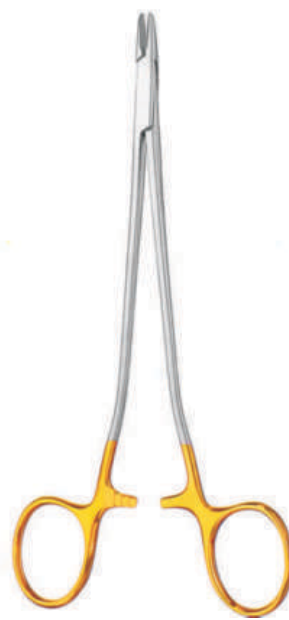

SENNING  
 KI-75.17



KI-76.15  
 15 cm / 6"

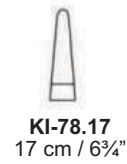

KI-78.17  
 17 cm / 6¾"



KI-77.16  
 15 cm / 6"



KI-79.18  
 17 cm / 6¾"

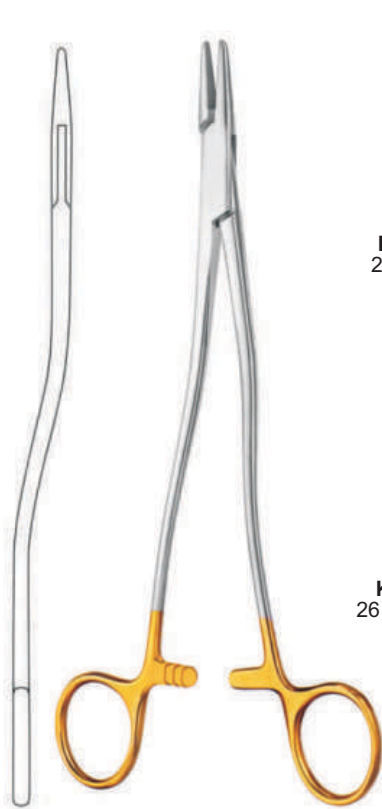

BOZEMANN  
 (WERTHEIM)

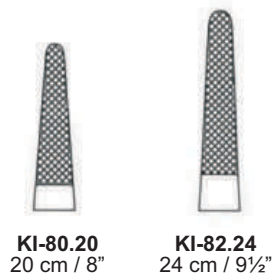

KI-80.20  
 20 cm / 8"

KI-82.24  
 24 cm / 9½"

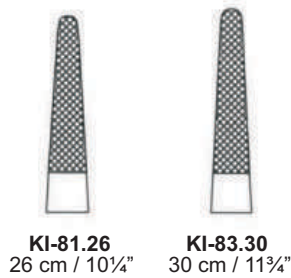

KI-81.26  
 26 cm / 10¼"

KI-83.30  
 30 cm / 11¼"



GILLIES  
 KI-84.16  
 15.5 cm / 6 1/8"

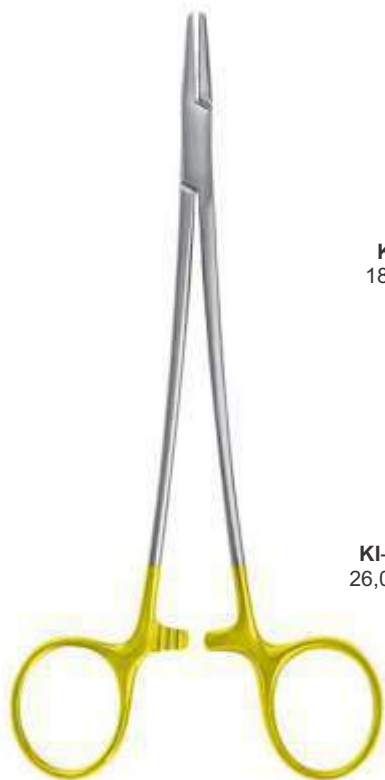

DE BAKEY



**KI-85-18**  
18,0 cm, 7"



**KI-86-20**  
20,0 cm, 8"



**KI-87-23**  
23,0 cm, 9"



**KI-88-26**  
26,0 cm, 10<sup>1</sup>/<sub>4</sub>"



**KI-89-31**  
31,0 cm, 12<sup>1</sup>/<sub>4</sub>"



**KI-90-37**  
37,0 cm, 14<sup>1</sup>/<sub>2</sub>"

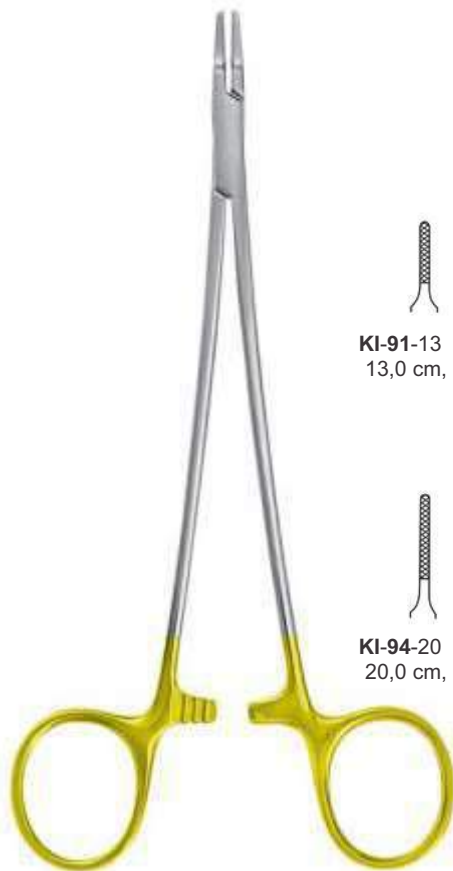

RYDER-VASCULAR



**KI-91-13**  
13,0 cm, 5"



**KI-92-15**  
15,0 cm, 6"



**KI-93-18**  
18,0 cm, 7"



**KI-94-20**  
20,0 cm, 8"



**KI-95-23**  
23,0 cm, 9"

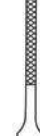

**KI-96-26**  
26,0 cm, 10<sup>1</sup>/<sub>4</sub>"



MATHIEU



**KI-97-14**  
14,0 cm, 5 $\frac{1}{2}$ "



**KI-98-17**  
17,0 cm, 6 $\frac{3}{4}$ "



**KI-99-20**  
20,0 cm, 8"



LICHTENBERG



**KI-100-17**  
17,0 cm, 6 $\frac{3}{4}$ "



**KI-101-20**  
20,0 cm, 8"



# NEEDLE HOLDERS



"Supporting Healthcare"  
**KAHA INDUSTRIES**  
Manufacturer Of Dental & Surgical Instruments



**Microvascular**

**KI-102.15**  
15 cm / 6"

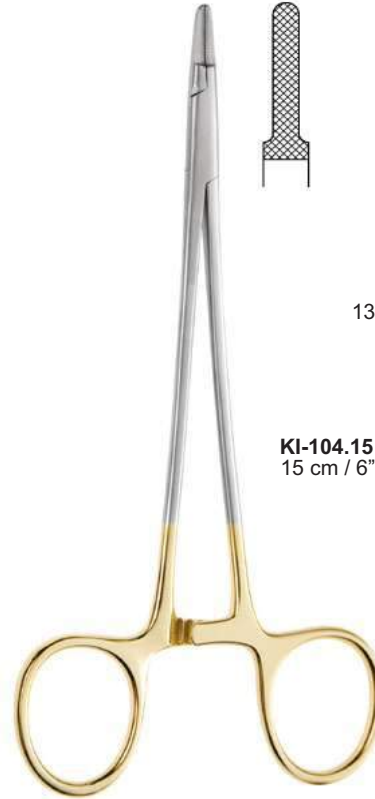

**Ryder T.C.**

**KI-103.13**  
13 cm / 5 1/8"

**KI-104.15**  
15 cm / 6"

**KI-105.18**  
18 cm / 7 1/8"



**BAUMGARTNER, T/C**

**KI-106-64**  
14 cm / 5 1/2"

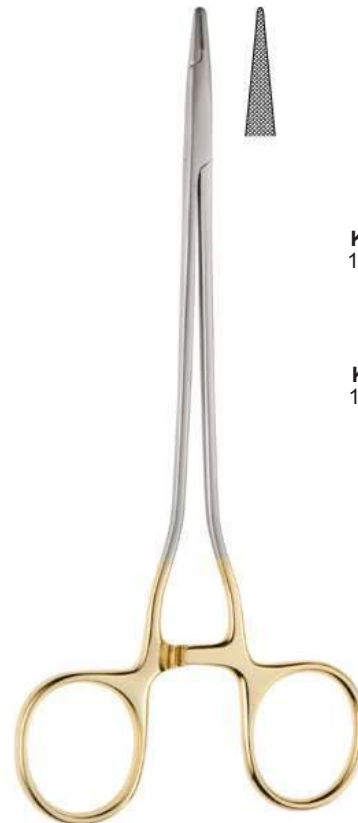

**Tebbetts T.C.**

**KI-107.14**  
14 cm / 5 1/2"

**KI-108.17**  
17 cm / 6 3/4"



Wire Twisting , T/C  
**KI-109-14**  
14 cm / 5½"



**KI-110.20**  
20 cm / 8"

**KI-111.24**  
24 cm / 9½"

**KI-112.26**  
26 cm / 10¼"

**KI-113.30**  
30 cm / 11¾"

Wertheim T.C. Needle Holder, S-Shape



Tebbetts Intranasal T.C. Needle Holder, Bayonet

**KI-114.20**  
20 cm / 8"

# NEEDLE HOLDERS



"Supporting Healthcare"  
**KAAHA INDUSTRIES**  
 Manufacturer Of Dental & Surgical Instruments



KI-115-14



KI-116-14



KI-117-14



KI-118-14

mit Sperre  
 with ratchet  
 con cremallera  
 con cremagliera

CASTROVIEJO  
 14,5 cm, 5<sup>3</sup>/<sub>4</sub>"



KI-119-18



KI-120-18



KI-121-18



KI-122-18

mit Sperre  
 with ratchet  
 con cremallera  
 con cremagliera

CASTROVIEJO  
 18,0 cm, 7"



KI-123-14



KI-124-14



KI-125-14



KI-126-14

mit Sperre  
 with ratchet  
 con cremallera  
 con cremagliera

BARRAQUER  
 14,5 cm, 5<sup>3</sup>/<sub>4</sub>"



HEPP SCHEIDEL  
 18,0 cm, 7"  
 KI-127-18



ADSON  
 12,0 cm, 4<sup>3</sup>/<sub>4</sub>" **KI-200-12**  
 15,0 cm, 6" **KI-201-15**



MICRO-ADSON  
 12,0 cm, 4<sup>3</sup>/<sub>4</sub>" **KI-202-12**  
 15,0 cm, 6" **KI-203-15**



STILLE  
 15,0 cm, 6"  
**KI-204-15**



TAYLOR  
 17,5 cm, 6<sup>5</sup>/<sub>8</sub>"  
**KI-206-17**



TAYLOR  
 17,5 cm, 6<sup>5</sup>/<sub>8</sub>"  
**KI-207-17**



TAYLOR  
 18,5 cm, 7<sup>1</sup>/<sub>4</sub>"  
**KI-208-18**



GERALD  
 18,0 cm, 7"  
**KI-209-18**



**GERALD**  
 18,0 cm, 7"  
**KI-210-18**



**POTTS-SMITH**  
 18,0 cm, 7" **KI-211-18**  
 21,0 cm, 8<sup>1</sup>/<sub>4</sub>" **KI-212-21**  
 25,0 cm, 10" **KI-213-25**



**POTTS-SMITH**  
 18,0 cm, 7" **KI-214-18**  
 21,0 cm, 8<sup>1</sup>/<sub>4</sub>" **KI-215-21**  
 25,0 cm, 10" **KI-216-25**



englische Modelle  
 english patterns  
 modelos ingleses  
 modelli inglese

13,0 cm, 5" **KI-217-13**  
 14,5 cm, 5<sup>3</sup>/<sub>4</sub>" **KI-218-14**  
 15,0 cm, 6" **KI-219-15**



**CUSHING**  
 17,5 cm, 6<sup>5</sup>/<sub>8</sub>"  
**KI-222-17**



**CUSHING**  
 17,5 cm, 6<sup>5</sup>/<sub>8</sub>"  
**KI-223-17**



**BROPHY**  
 20,0 cm, 8"  
**KI-224-20**



ADSON BROWN  
**KI-235.72**  
 12 cm / 4¾"



ADSON GRAEFE  
**KI-236.82**  
 12 cm / 4¾"



SEMKEN



**KI-237.12**  
 12 cm / 4¾"



**KI-238.22**  
 12 cm / 4¾"



**KI-239.15**  
 15 cm / 6"



**KI-240.25**  
 15 cm / 6"



SEMKEN



**KI-241.12**  
 12 cm / 4¾"



**KI-242.22**  
 12 cm / 4¾"



**KI-243.15**  
 15 cm / 6"



**KI-244.25**  
 15 cm / 6"



SEMKEN  
**KI-245.32**  
 12 cm / 4¾"



MCINDOE  
**KI-246.15**  
 15 cm / 6"



# Dressing & Tissue Forceps



"Supporting Healthcare"  
**KAAHA INDUSTRIES**  
 Manufacturer Of Dental & Surgical Instruments



**GILLIES**  
**KI-247.85**  
 15 cm / 6"



**KI-248.15**  
 15 cm / 6"



**WAUGH**



**KI-249.15**  
 15 cm / 6"



**WAUGH**



**KI-250.20**  
 20 cm / 8"



**KI-251.20**  
 20 cm / 8"



**KI-252.40**  
 20 cm / 8"



**DEBAKEY**  
**KI-253.15**  
 15 cm / 6"



**NELSON**



**KI-254.15**  
 15 cm / 6"



**KI-255.23**  
 23 cm / 9"



**WALTER**  
**KI-256.26**  
 16 cm / 6 1/4"



**WALTER**  
**KI-257.36**  
 16 cm / 6 1/4"

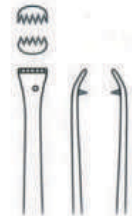



**GRUENWALD**  
**KI-258.16**  
 16 cm / 6¼"



**TROELTSCH (WILDE)**  
**KI-259.13**  
 13 cm / 5"

**Suturing Forceps**  
 Pinzas para sutura  
 Pinces à suture  
 Pinze per sutura

	0.3 mm	0.3 mm	0.3 mm	0.3 mm		0.6 mm
	<b>KI-260.50</b> 12 cm / 4¾"	<b>KI-263.51</b>	<b>KI-266.52</b>	<b>KI-269.53</b>		<b>KI-272.84</b> 23 cm / 9"
<b>KI-261.60</b> 15 cm / 6"	<b>KI-264.61</b>	<b>KI-267.62</b>	<b>KI-270.63</b>			
<b>KI-262.70</b> 18 cm / 7 1/8"	<b>KI-265.71</b>	<b>KI-268.72</b>	<b>KI-271.73</b>			





WALTER  
**KI-273.18**  
 8 cm / 3 1/8"



COTTLE  
**KI-274.15**  
 15 cm / 6"



FOX



**KI-275.13**  
 13 cm / 5 1/8"



**KI-276.15**  
 15 cm / 6"



FOX  
**KI-277.15**  
 15 cm / 6"



COTTLE  
**KI-278.15**  
 15 cm / 6"



CUSHING  
 17,5 cm, 6<sup>5</sup>/<sub>8</sub>"  
**KI-279-17**



CUSHING  
 17,5 cm, 6<sup>5</sup>/<sub>8</sub>"  
**KI-280-17**



**GERALD**  
 18,0 cm, 7"  
**KI-281-18**



**GERALD**  
 18,0 cm, 7"  
**KI-282-18**

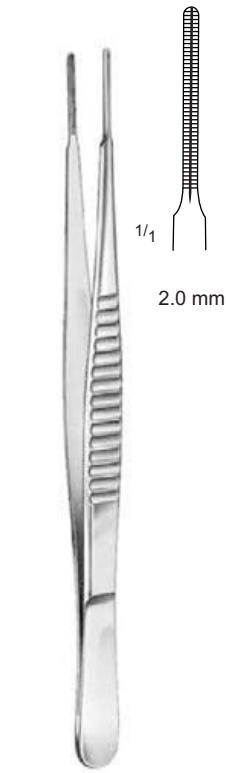

**COOLEY**  
**KI-283-16** – 16 cm / 6<sup>1</sup>/<sub>4</sub>"  
**KI-284-20** – 20 cm / 8"

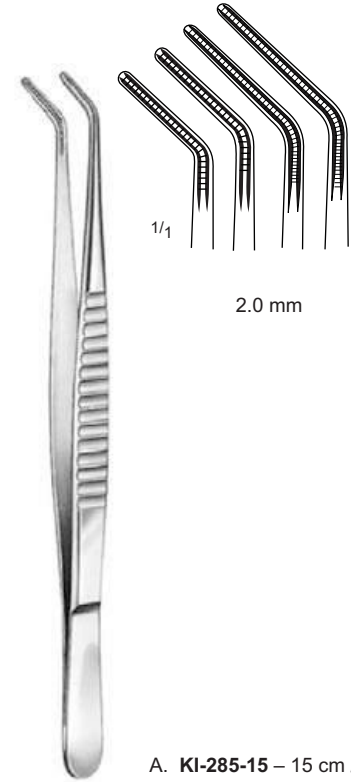

**A. KI-285-15** – 15 cm / 6"  
**B. KI-286-19** – 19 cm / 7<sup>3</sup>/<sub>4</sub>"  
**C. KI-287-24** – 24 cm / 9<sup>2</sup>/<sub>2</sub>"  
**D. KI-288-30** – 30 cm / 12"

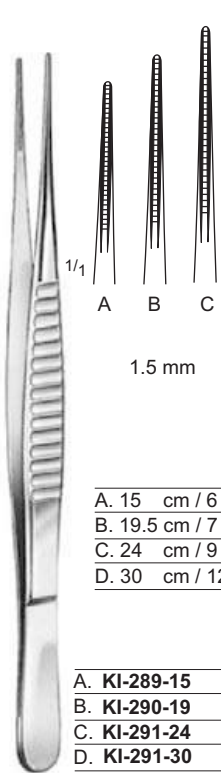

**A. 15 cm / 6"**  
**B. 19.5 cm / 7<sup>3</sup>/<sub>4</sub>"**  
**C. 24 cm / 9<sup>1</sup>/<sub>2</sub>"**  
**D. 30 cm / 12"**

**A. KI-289-15**  
**B. KI-290-19**  
**C. KI-291-24**  
**D. KI-291-30**

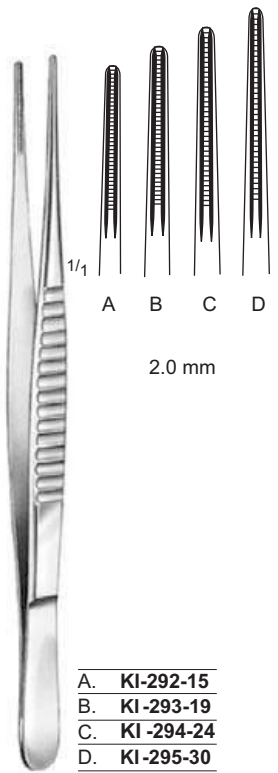

**A. KI-292-15**  
**B. KI-293-19**  
**C. KI-294-24**  
**D. KI-295-30**

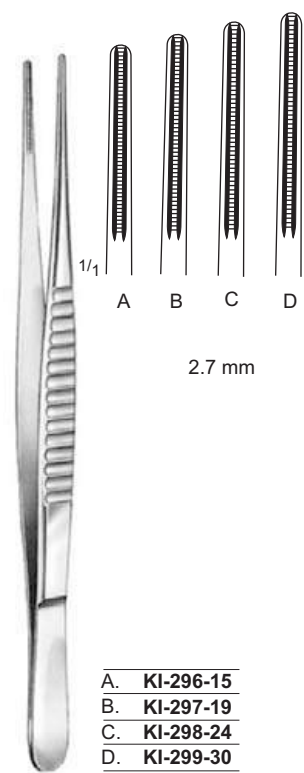

**A. KI-296-15**  
**B. KI-297-19**  
**C. KI-298-24**  
**D. KI-299-30**

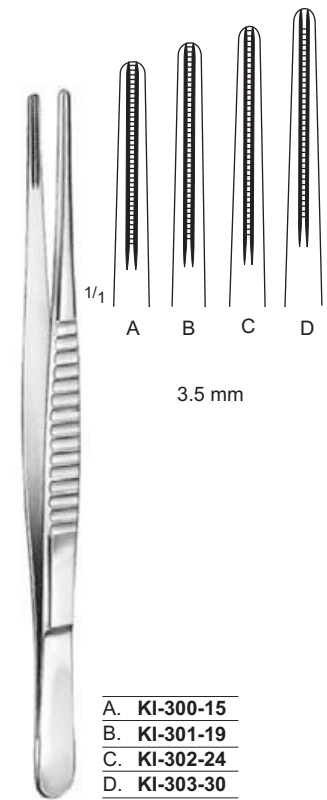

**A. KI-300-15**  
**B. KI-301-19**  
**C. KI-302-24**  
**D. KI-303-30**

# Dressing & Tissue Forceps



"Supporting Healthcare"  
**KAAHA INDUSTRIES**  
 Manufacturer Of Dental & Surgical Instruments



**ADSON**  
 17,5 cm, 6<sup>5</sup>/<sub>8</sub>"

12,0 cm, 4<sup>3</sup>/<sub>4</sub>"  
**KI-304-12**



12,0 cm, 4<sup>3</sup>/<sub>4</sub>"  
**KI-305-12**

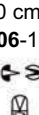
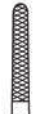

15,0 cm, 6"  
**KI-306-15**



15,0 cm, 6"  
**KI-306-115**

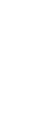

**CUSHING**  
 17,5 cm, 6<sup>5</sup>/<sub>8</sub>"

**KI-307-17**



**KI-308-17**



**BONNEY**  
 17,5 cm, 6<sup>5</sup>/<sub>8</sub>"  
**KI-313-17**



**GERALD**  
 17,0 cm, 6<sup>3</sup>/<sub>4</sub>"

**KI-309-17**



**KI-310-17**



**GILLIES**  
 15,0 cm, 6"  
**KI-311-15**



**MC INDOE**  
 15,0 cm, 6"  
**KI-312-15**





**VESSEL DILATOR**

Item Code	Description
<b>KI-400-001</b>	ANGLED, 11cm/ 4¼", 0.2mmØ



**VESSEL DILATOR**

Item Code	Description
<b>KI-401-002</b>	ANGLED, 11cm/ 4¼", 0.3mmØ



**VESSEL DILATOR**

Item Code	Description
<b>KI-402-003</b>	ANGLED, 13.5cm/ 5 3/8", 0.2mmØ



**VESSEL DILATOR**

Item Code	Description
<b>KI-403-004</b>	LONG ANGLED, 13.5cm/ 5 3/8", 0.2mmØ



**VESSEL DILATOR**

Item Code	Description
<b>KI-404-005</b>	LONG ANGLED, 18cm/ 7", .3mmØ



**VESSEL DILATOR**

Item Code	Description
<b>KI-405-006</b>	LONG ANGLED, 18cm/ 7", 0.2mmØ



**ROUND BODIED VESSEL DILATOR**

Item Code	Description
<b>KI-406-007</b>	15cm/ 6", 0.3mmØ, BALANCED FORCEKI



**ROUND BODIED VESSEL DILATOR**

Item Code	Description
<b>KI-407-008</b>	CURVED, 15cm/ 6", 0.2mmØ, BALANCED FORCEKI



**ROUND BODIED VESSEL DILATOR**

Item Code	Description
<b>KI-408-009</b>	18cm/ 7", 0.3mmØ, BALANCED FORCEKI



**ROUND BODIED VESSEL DILATOR**

Item Code	Description
<b>KI-409-010</b>	CURVED, 18cm/ 7", 0.3mmØ, BALANCED FORCEKI



**JEWELLERS FORCEKI**

Item Code	Description
<b>KI-410-011</b>	11cm/ 4¼", 0.3mmØ



**JEWELLERS FORCEKI**

Item Code	Description
<b>KI-411-012</b>	LONG, 15cm/ 6", 0.3mmØ



**JEWELLERS FORCEKI**

Item Code	Description
<b>KI-412-013</b>	12cm/ 4¾", 0.3mmØ



**JEWELLERS FORCEKI**

Item Code	Description
<b>KI-413-014</b>	13.5cm/ 5 3/8", 0.3mmØ



Pierse Forceps have a micro hole in the tips which securely grip tissue with minimal trauma



**PIERSE FORCEKI**

Item Code	Description
<b>KI-414-015</b>	12cm/ 4 3/4", 0.3mmØ



**MICRO ADSON FIXATION FORCEKI**

Item Code	Description
<b>KI-415-016</b>	12cm/ 4 3/4", 0. 5mmØ, 1X2 MICRO TEETH



**ROUND BODIED FORCEKI**

Item Code	Description
<b>KI-416-017</b>	15cm/ 6", STRAIGHT, WITH PLATFORM, 0.3mmØ



**ROUND BODIED FORCEKI**

Item Code	Description
<b>KI-417-018</b>	15cm/ 6", CURVED, WITH PLATFORM, 0.3mmØ



**ROUND BODIED FORCEKI**

Item Code	Description
<b>KI-418-019</b>	15cm/ 6", ANGLED, 0.2mmØ



**ROUND BODIED FORCEKI**

Item Code	Description
<b>KI-419-020</b>	18cm/ 7", STRAIGHT, 0.5mmØ

## “Pictures”

## “Dimentions”

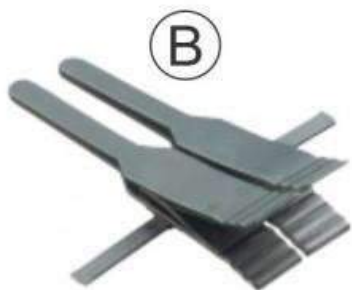
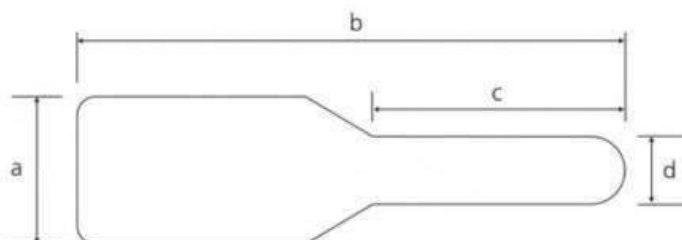
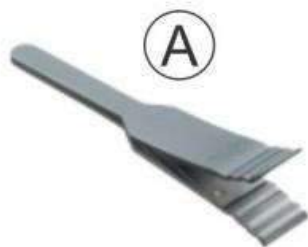

Serial Serie	a	b	c	d
RD	6.0	36	16	3.0
HD	4.0	24	10	2.2
B-3	3.5	16.6	7.5	1.7
B-2	3.0	11.3	5.5	1.5
B-1	2.2	8.0	3.8	1.1

Micro Vessel Clips, acc. to Acland, Clip Applying Forceps

KI-420.00



### Blondeel Scissors Round Handle

Item Code	Description
<b>KI-421.01</b>	15cm/ 6", 15mm LONG BLADES
<b>KI-422.02</b>	18cm/ 15mm LONG BLADES



### Double Action Micro Needle Holder, Round Bodied

Item Code	Description
<b>KI-423.01</b>	15cm/ 6", 0.4mm JAWS
<b>KI-424.02</b>	18cm/ 0.4mm JAWS



### FECHTNER CONJUNCTIVA FORCEPS

Item Code	Description
<b>KI-425.01</b>	10cm LONG



### Bishop harmon Iris Forceps

Item Code	Description
<b>KI-426.01</b>	0.3mm, Plain, 9cm LONG
<b>KI-426.02</b>	0.3mm, 1X2TH, 9cm LONG





### Putterman clamp, Stainless Steel

Item Code	Description
KI-427.01	10cm LONG



### Putterman Gladstone Transmarginal Clamp

Item Code	Description
KI-428.01	10cm LONG



### Castroviejo Suturing Forcep 1x2 Teeth, 0.9mm Tip

Item Code	Description
KI-429.01	11cm LONG



**Adson Coagulating Forceps,  
Serrated, Insulated**

**KI-500.12**  
12 cm / 4 <sup>3</sup>/<sub>4</sub>"



**Adson Insulated Bipolar,  
Forceps, Flat Plug, Non Stick**

**KI-501.12**  
12 cm / 1mm Tip



**Cushing Bayonett Insulated  
Bipolar Forceps, 2 Pins Plug,  
Non Stick**

**KI-502.18**  
18cm



**Cushing Bayonett Insulated  
Bipolar Forceps, Flat Plug  
Non Stick**

**KI-503.18**  
18cm/ 1mm  
Tip



**Jewelers Insulated Bipolar  
Forceps, 11.5cm, Flat Plug**

**KI-504.12**  
0.3mm-11.5cm

**KI-505.12**  
0.6mm-11.5cm



**Potts-Smith Insulated Bipolar  
Forceps, Straight, 2 Pins Plug  
Non Stick**

**KI-506.18**  
0.6mm-18cm

**KI-507.18**  
1.0mm-18cm

**KI-508.18**  
2.0mm-18cm



**KI-509.18**  
0.6mm-18cm

**KI-510.18**  
1.0mm-18cm

**KI-511.18**  
2.0mm-18cm

**Potts-Smith Insulated Bipolar  
Forceps, Straight, Flat Plug  
Non Stick**



**KI-512.15**  
0.6mm-15cm

**KI-513.15**  
1.0mm-15cm

**Semken Insulated Bipolar  
Forceps, Straight, 2 Pins Plug  
Non Stick**



**KI-514.15**  
0.6mm-15cm

**KI-515.15**  
1.0mm-15cm

**Semken Insulated Bipolar  
Forceps, Angled, 2 Pins Plug  
Non Stick**



**KI-1000.20**  
**Gerald (Straight), 1mm Tip,  
20cm Long, 2 Pins Plug  
Non Stick**



**Finger Switch Pencil, Reusable  
With 3 Meter Silicon Coated Cable**  
KI-516.00



**Silicon Coated Bipolar  
Cable, 2 Pins Plug  
3.0 Meters Length**  
KI-517.00



**Silicon Coated Bipolar  
Cable, Flat Plug  
3.0 Meters Length**  
KI-518.00

# Scalpel Handles



"Supporting Healthcare"  
**KAAHA INDUSTRIES**  
 Manufacturer Of Dental & Surgical Instruments



**KI-60.10**  
Fig. 10



**KI-61.11**  
Fig. 11



**KI-62.12**  
Fig. 12



**KI-63.32**  
Fig. 12d



**KI-64.15**  
Fig. 15



**KI-65.35**  
Fig. 15c



**KI-66.35**  
Fig. 15c



**KI-67.23**  
Fig. 23



**KI-68.03**  
No.3  
12.5 cm / 5"



**KI-69.07**  
No.7  
16.5 cm / 6½"



**KI-70.17**  
No.7K  
12 cm / 4¾"



**KI-71.13**  
No.3L  
21 cm / 8¼"



**KI-72.23**  
No.3LA  
20.5 cm / 8"



**KI-73.40**  
15.5 cm / 6 1/8"

# Scalpel Handles



"Supporting Healthcare"  
**KAAHA INDUSTRIES**  
Manufacturer Of Dental & Surgical Instruments



**KI-74.45**  
22.5 cm / 9"



**KI-75.53**  
27 cm / 10¾"



**KI-76.61**  
21 cm / 8¼"



**KI-77.63**  
15.5 cm / 6 1/8"



**KI-78.64**  
21 cm / 8¼"

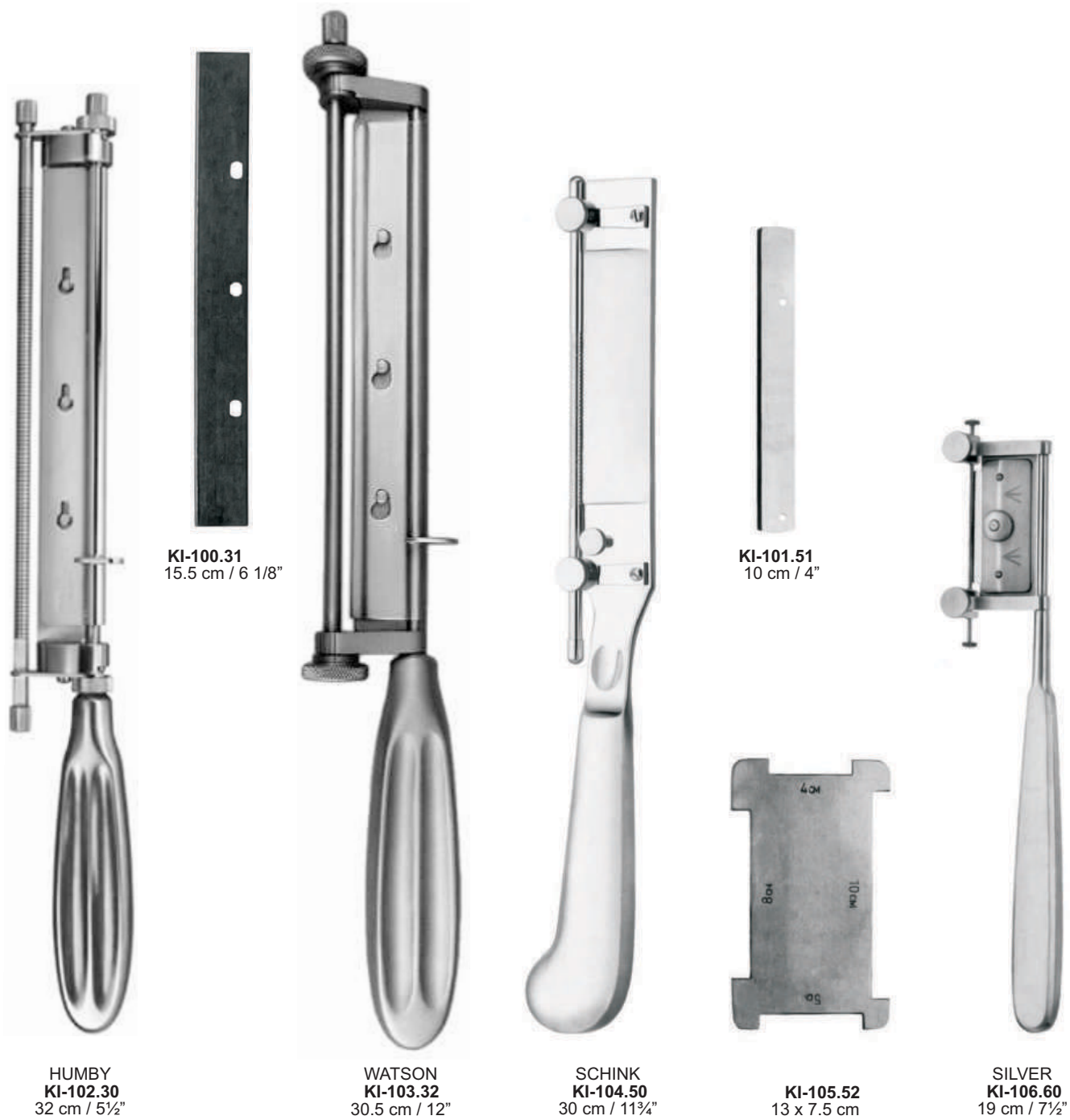

# MALLETS



"Supporting Healthcare"  
**KAAHA INDUSTRIES**  
 Manufacturer Of Dental & Surgical Instruments

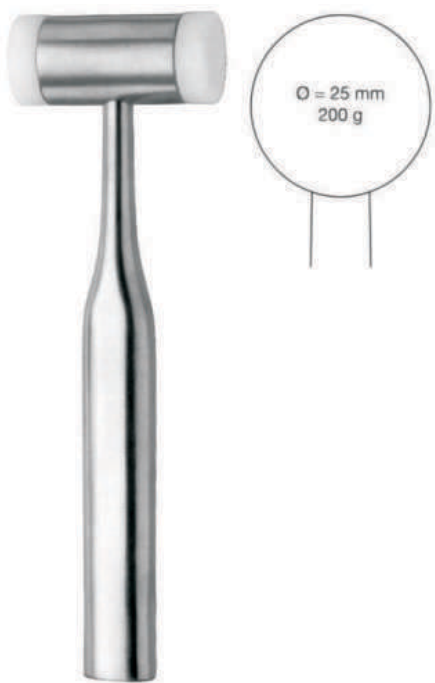

**KI-100.18**  
 18.5 cm / 7¼"



**COTTLE**  
**KI-101.40**  
 19 cm / 7½"

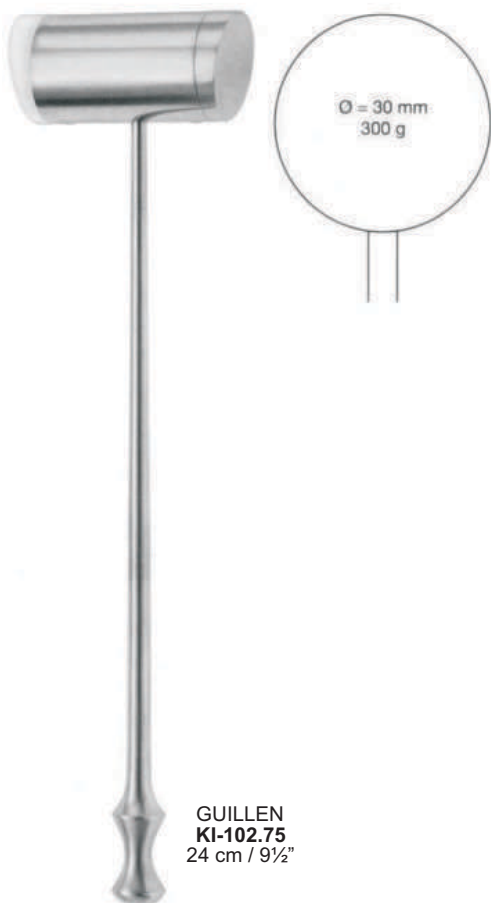

**GUILLEN**  
**KI-102.75**  
 24 cm / 9½"

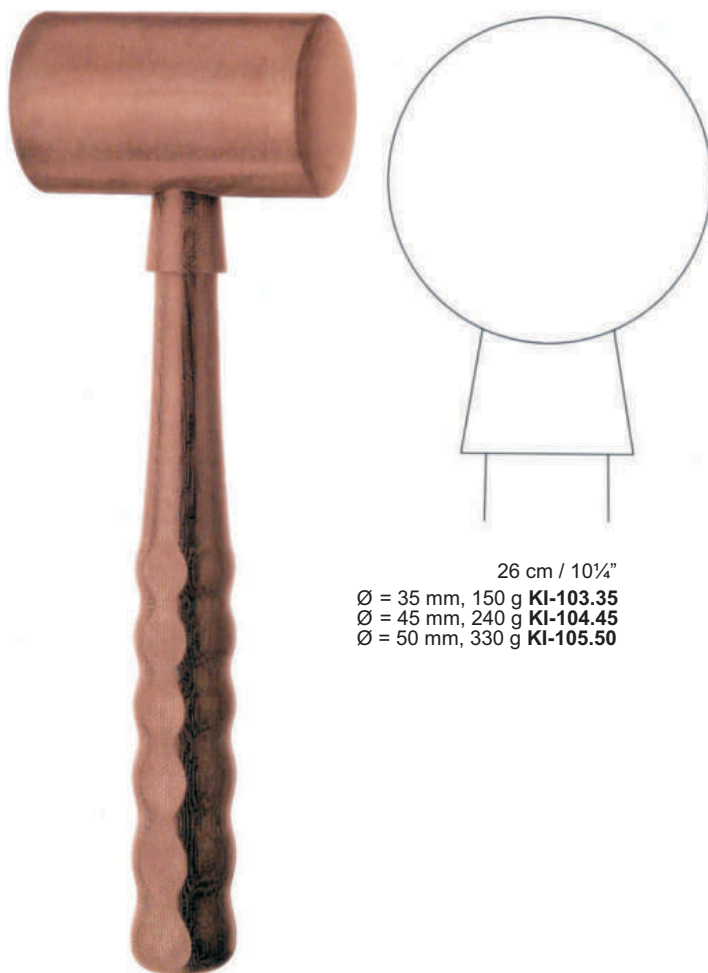

26 cm / 10¼"  
 Ø = 35 mm, 150 g **KI-103.35**  
 Ø = 45 mm, 240 g **KI-104.45**  
 Ø = 50 mm, 330 g **KI-105.50**



# MALLETS



"Supporting Healthcare"  
**KAAHA INDUSTRIES**  
 Manufacturer Of Dental & Surgical Instruments

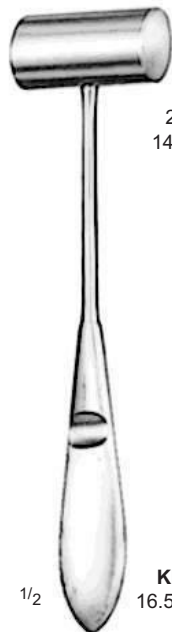

20 mm ø  
 140 g (5 oz)

1/2

**KI-106-16**  
 16.5 cm / 6 1/2"



40 mm ø  
 690 g  
 (1 1/2" lbs)

**KIK**  
**KI-107-20**  
 19.5 cm / 7 3/4"



30 mm & 42 mm ø  
 530 g 1lb. 3 oz)

1/2

**KI-108-24**  
 24 cm / 9 1/2"



**KI-109-01**  
 25m ø  
 120 g (4 1/4 oz)

**KI-110-02**  
 30m ø  
 180 g (6 1/4 oz)

**KI-111-03**  
 35m ø  
 260 g (9 1/4 oz)

1/2

**DOYEN**  
**KI-109-01 – KI-111-03**  
 21 cm / 8 1/4"



**Bergmann**  
**KI-114-23**  
 24 cm / 9"



30 mm ø  
 220 gm  
 (7 1/2 oz)

1/2

**COLLIN**  
**KI-115-20**  
 20 cm / 8"



### YANCOSKIE CORONAL LIFT RETRACTOR

Item Code	Description
<b>KI-200.21</b>	OFFSET 8½" (216mm) WIDTH 150mm.



### YANCOSKIE ABDOMINOPLASTY RET.

Item Code	Description
<b>KI-201.19</b>	OFFSET 7½" (190mm) WIDTH 150mm



### FREEMAN FACE LIFT RETRACTOR

Item Code	Description
<b>KI-202.01</b>	SMALL FINGER RING, 4" (102mm) WIDTH 21.8mm
<b>KI-203.02</b>	LARGE FINGER RING, 4¾" (121mm) WIDTH 25mm



**MAMMAPLASTY OR MASTECTOMY HOOK**

Item Code	Description
<b>KI-204.19</b>	EXTRA LARGE, SHARP, 7½" (191mm), 10mm



**FREEMAN SKIN HOOK, 4" (102mm)**

Item Code	Description
<b>KI-205.10</b>	SINGLE SHARP HOOK, 5mm
<b>KI-206.10</b>	DOUBLE SHARP HOOK, 5mm



**Anderson Bear Claw Retractor**

Item Code	Description
<b>KI-207.07</b>	THREE PRONG, 12CM
<b>KI-208.12</b>	FIVE PRONG, 12CM



**MILLARD THUMB SINGLE HOOK**

Item Code	Description
<b>KI-209.05</b>	STANDARD, 5mm



**MILLARD THUMB DOUBLE HOOK**

Item Code	Description
<b>KI-210.17</b>	STANDARD, 17mm



**FREEMAN FACE LIFT RETRACTOR**

Item Code	Description
<b>KI-211.18</b>	ADAMSON MODEL, 7”(178mm), 37mm



Item Code	Description
<b>KI-212.11</b>	<b>FREEMAN FLAP RAKE RETRACTOR</b> 4¼” (108mm), 1¼”(32mm)



**FREEMAN RAKE RETRACTOR**

Item Code	Description
<b>KI-213.10</b>	4” (100mm), WIDTH (22mm)
<b>KI-214.10</b>	4” (100mm), WIDTH (38mm)



**GORNEY RAKE RETRACTOR**

Item Code	Description
<b>KI-215.08</b>	3” (75mm), WIDTH (38mm)
<b>KI-216.11</b>	4¼” (108mm), WIDTH (38mm)



**SWIVEL DOUBLE HOOK/RETRACTOR**

Item Code	Description
<b>KI-217.09</b>	2 SHARP PRONG WITH SWIVEL RING 3½" (89mm), 10mm



**MARTINEZ-KILNER NASAL RETRACTOR**

Item Code	Description
<b>KI-218.11</b>	2 SHARP PRONGS WITH THUMB RING 4½" (114mm) 7.5mm



**SHEEN NASAL RETRACTOR**

Item Code	Description
<b>KI-219.17</b>	ANGLED, 6½" (165mm), 10mm



**SHEEN RETRACTOR**

Item Code	Description
<b>KI-220.16</b>	CURVED, 6¼" (159mm), 6.5mm



**RIBBON RETRACTOR**

Item Code	Description
<b>KI-221.17</b>	INFANT, 6¾" (171mm), 5/8" (16mm)
<b>KI-222.20</b>	PEDIATRIC, 8" (203mm), 5/8" (16mm)
<b>KI-223.20</b>	PEDIATRIC, 8" (203mm), 1" (25mm)

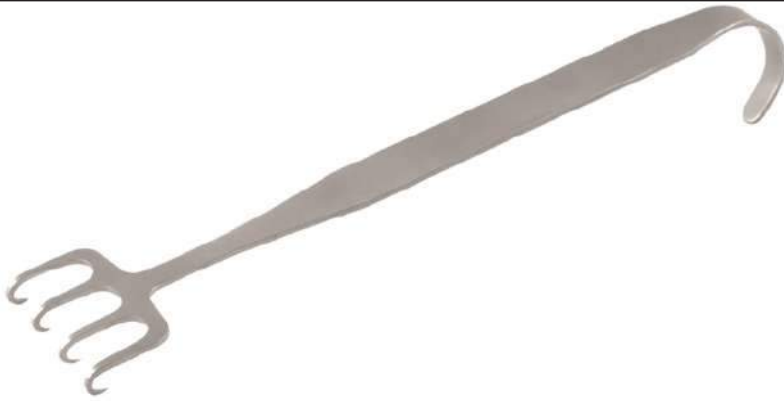

### Freeman Rake Retractor

Item Code	Description
KI-224.10	18cm,WIDTH (22mm)
KI-225.10	18cm, WIDTH (38mm)



Item Code	Description
KI-226.11	<b>Cronin Lip And Nostril Retractor 15.5cm</b>



### Walter Rake Retractor

Item Code	Description
KI-227.10	18cm,WIDTH (22mm)
KI-228.10	18cm, WIDTH (38mm)



### Coronal Brow Lift 7 Prongs Retractor

Item Code	Description
KI-229.18	7 Prongs , 18cm



**U.S. ARMY RETRACTOR, SET OF 2**

Item Code	Description
<b>KI-230.21</b>	8½" (216mm)



**U.S. ARMY RETRACTOR insulated, SET OF 2**

Item Code	Description
<b>KI-231.21</b>	8½" (216mm)



**Farabeuf Retractor Set of 2**

Item Code	Description
<b>KI-232.10</b>	Set of 2 (12cm)
<b>KI-233.10</b>	Set of 2 (15cm)



**Farabeuf Retractor Set of 2, Insulated**

Item Code	Description
<b>KI-234.10</b>	Set of 2 (12cm)
<b>KI-235.10</b>	Set of 2 (15cm)



**Senn Miller Retractor Insulated, 16cm, Sharp And Blunt**

KI-236.16 SHARP PRONGS

KI-237.16 BLUNT PRONGS



**Kawamoto Double Ended Retractor, 16cm, INSULATED**

KI-238.16 No. 1

KI-239.16 No. 2

KI-240.16 No. 3



**Fomon Retractor, Insulated, 17cm**

KI-241.17 Ball Tips, 5x10mm



**Desmarres Eye Lid Retractor, 14cm, INSULATED**

KI-242.00 No. 0

KI-243.01 No. 1

KI-244.02 No. 2

KI-245.03 No. 3

KI-246.04 No. 4





### DEAVER RETRACTOR,

Item Code	Description
<b>KI-247.30</b>	12" (305mm), 1" (25mm)



### Deaver Retractor Insulated, 20cm, 25mm Wide

Item Code	Description
<b>KI-248.20</b>	8" (305mm), 1" (25mm)

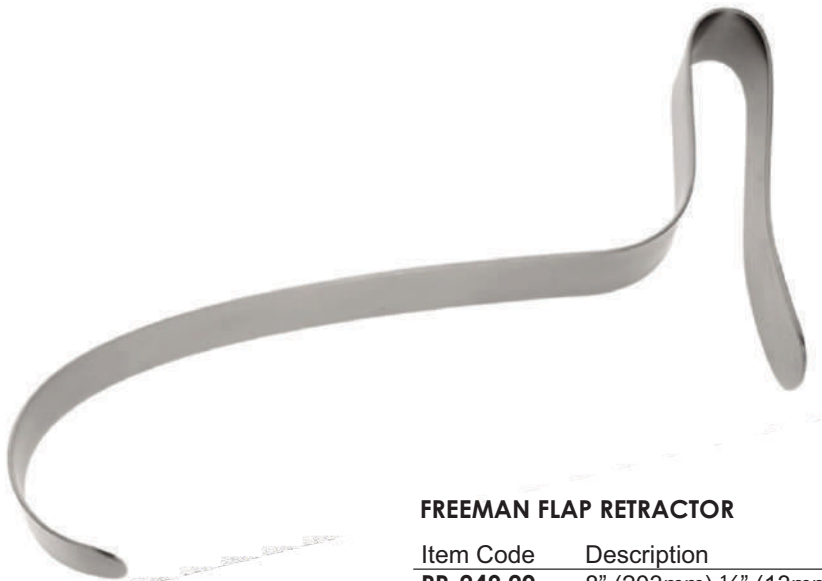

### FREEMAN FLAP RETRACTOR

Item Code	Description
<b>PR-249.20</b>	8" (203mm) ½" (13mm)
<b>PR-250.20</b>	8" (203mm) 1" (25mm)



**KIKER RETRACTOR, SET OF 2**

Item Code	Description
<b>KI-251.21</b>	Set of 2, 13cm



**Roux Baby Retractor**

Item Code	Description
<b>KI-252.21</b>	8½" (216mm)



**Roux Retractors, Set of 3**

Item Code	Description
<b>KI-253.16</b>	16CM

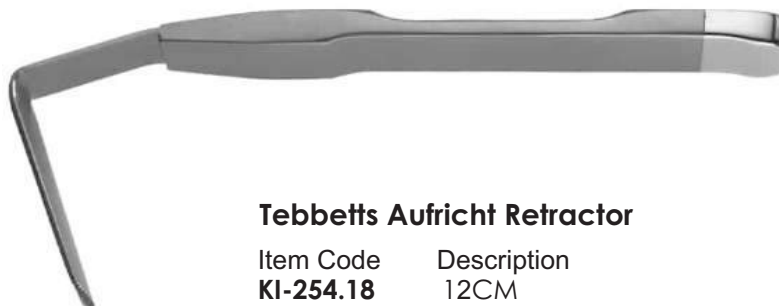

**Tebbetts Aufricht Retractor**

Item Code	Description
<b>KI-254.18</b>	12CM



**Epstein-Deaver Retractor, 20cm, 25mm Wide**

Item Code	Description
<b>KI-255.20</b>	8" (200mm), 1" (25mm)



**Richardson Retractor, 25cm, 19mm X 25mm Blade**

Item Code	Description
<b>KI-256.25</b>	10" (250mm)



**Richardson Retractor Double Ended Set of 2**

Item Code	Description
<b>KI-257.20</b>	Large Blade: 27cm Length, 63mm x 42mm / 39mm x 37mm Wide
<b>KI-258.20</b>	Small Blade: 20cm Length, 30mm x 29mm / 24mm x 22mm Wide



### Meyerding Retractor

Item Code	Description
KI-259.20	Medium Blade 25mm x 75mm 20cm
KI-260.20	Large Blade 50mm x 90mm 23cm



### Rollet Retractor 4 Prongs

Item Code	Description
KI-261.25	14CM



### Cronin Cheek Retractor, 16cm, 19mm Wide

Item Code	Description
KI-262.16	6" (160mm)(19mm)



**Saldanha Abdominal Retractor 23cm Style-1, Six Prongs**

**KI-300.20**

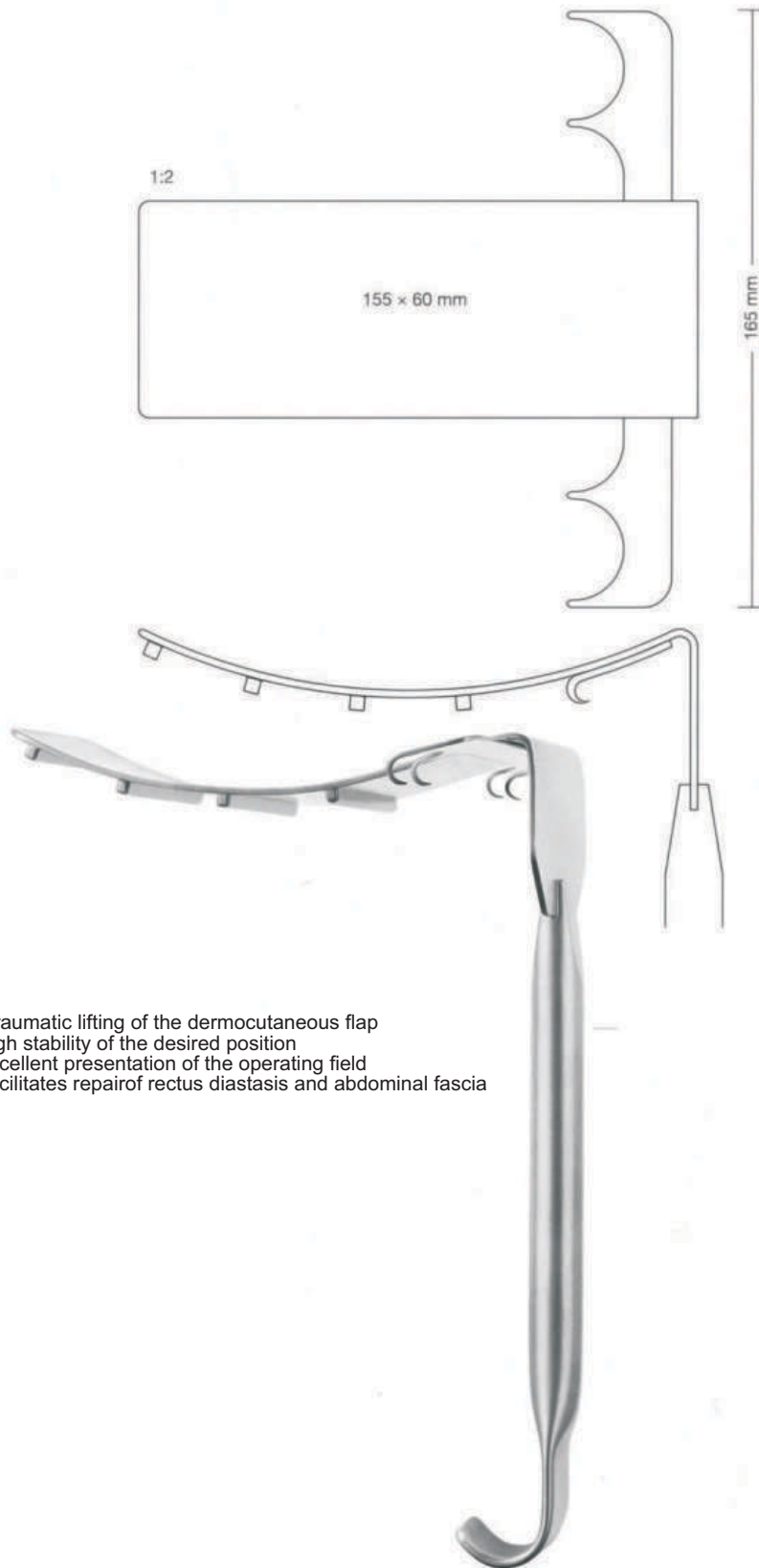

Atraumatic lifting of the dermocutaneous flap  
High stability of the desired position  
Excellent presentation of the operating field  
Facilitates repair of rectus diastasis and abdominal fascia

**Saldanha Abdominal Retractor 23cm Style-2, Four Prongs**

**KI-301.20**

# DELICATE RETRACTORS



"Supporting Healthcare"  
**KAAHA INDUSTRIES**  
 Manufacturer Of Dental & Surgical Instruments

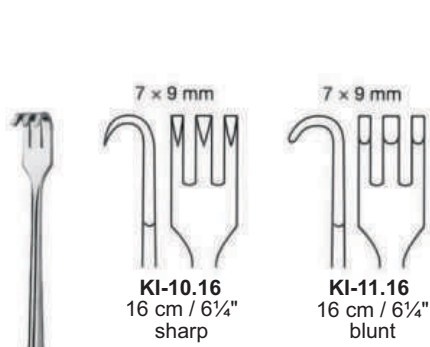

SENN MILLER



RAGNELL  
 KI-12.16  
 16 cm / 6 1/4"

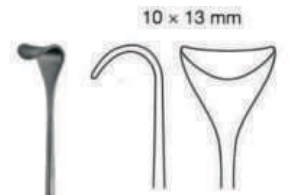

COPE  
 KI-13.18  
 18 cm / 7 1/8"

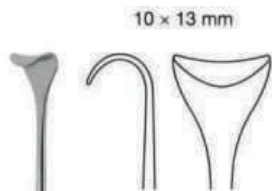
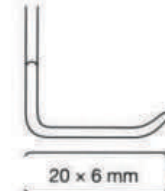
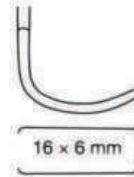

COPE WALTER  
 KI-14.25  
 16 cm / 6 1/4"



SENN GREEN

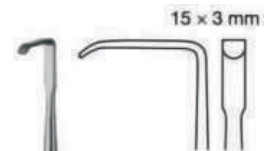
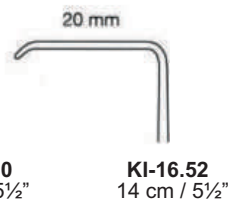

KI-17.58  
 18 cm / 7 1/8"



# DELICATE RETRACTORS



"Supporting Healthcare"  
**KAAHA INDUSTRIES**  
 Manufacturer Of Dental & Surgical Instruments

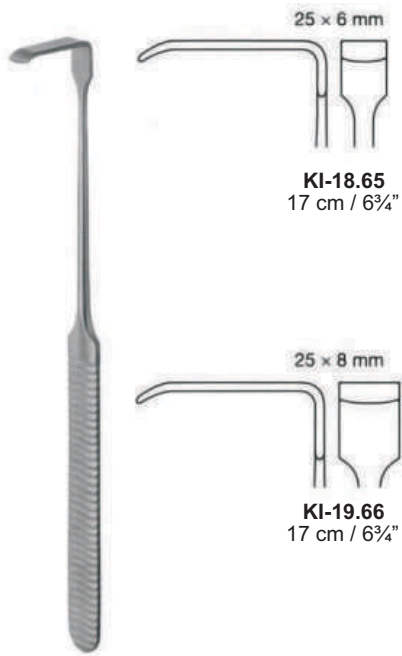

LANGENBECK GREEN

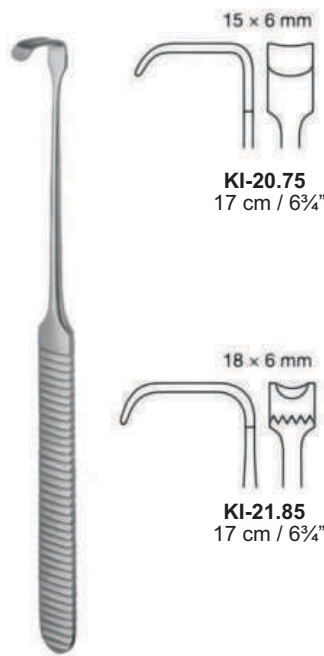

STRANDELL STILLE



ADSON



CRILE  
 KI-24.20  
 20 cm / 8 "



FRAZIER  
 KI-25.12  
 12.5 cm / 5 "



GILLIES



# DELICATE RETRACTORS



"Supporting Healthcare"  
**KAAHA INDUSTRIES**  
 Manufacturer Of Dental & Surgical Instruments

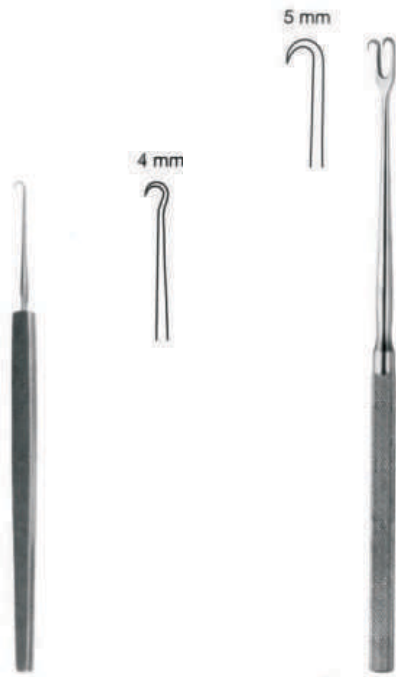

**STRAIGHT**  
**KI-28.13**  
 13 cm / 5 1/8 "

**JOSEPH**

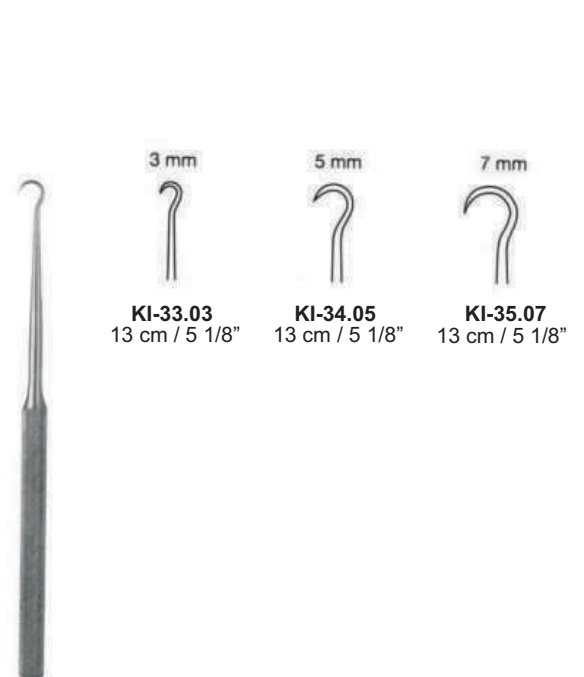

**KLEINERT KUTZ**



**BARSKY**  
**KI-36.15**  
 15 cm / 6"

**BARSKY**  
**KI-37.16**  
 15 cm / 6"



**JACKSON**  
**KI-38.14**  
 14.5 cm / 5 3/8"



**NEWS**  
**KI-39.15**  
 15 cm / 6"

# DELICATE RETRACTORS



"Supporting Healthcare"  
**KAAHA INDUSTRIES**  
 Manufacturer Of Dental & Surgical Instruments



JOSEPH  
 KI-40.16  
 16 cm / 6¼"



HUMBY  
 KI-41.21  
 11.5 cm / 4½"



BERGMANN  
 KI-42.24  
 14 cm / 5½"



KI-43.26  
 16.5 cm / 6½"



COTTLE  
 KI-44.36  
 16 cm / 6¼"



EMMET  
 KI-45.42  
 22 cm / 8¾"



BENICKE



KI-46.50  
 19 cm / 7½"  
 sharp



KI-47.51  
 19 cm / 7½"  
 blunt



GUTHRIE

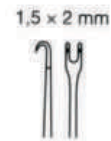

KI-48.13  
 13 cm / 5 1/8"



KI-49.23  
 13 cm / 5 1/8"

# DELICATE RETRACTORS



"Supporting Healthcare"  
**KAAHA INDUSTRIES**  
 Manufacturer Of Dental & Surgical Instruments

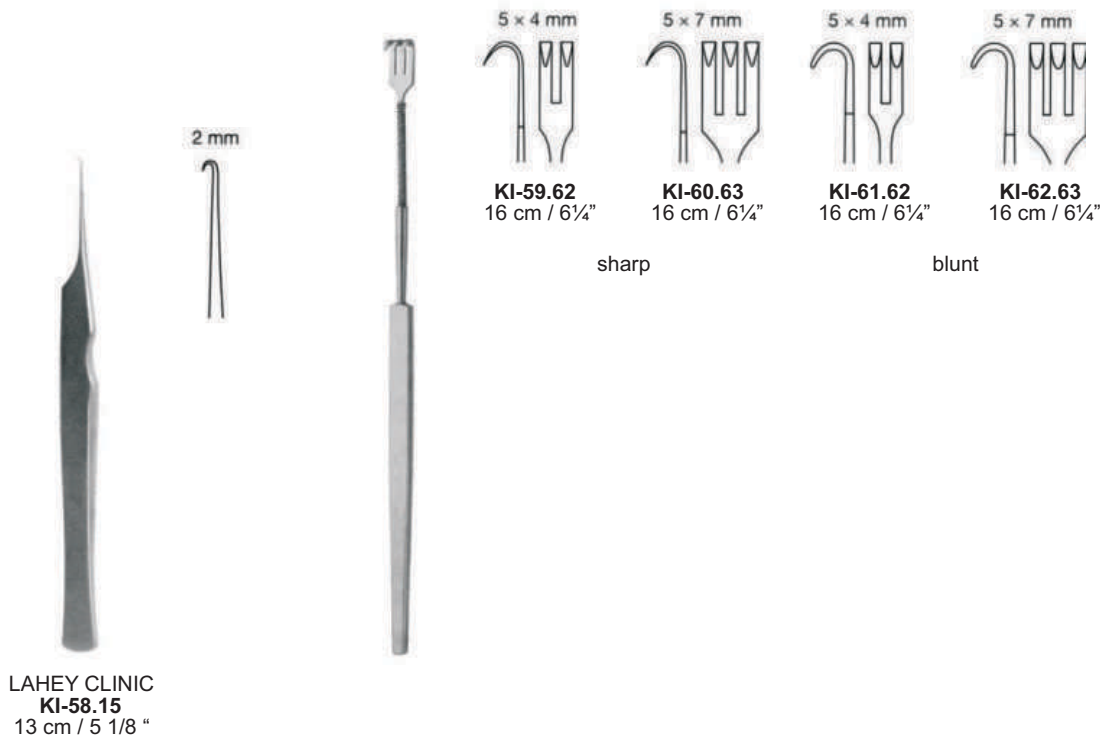
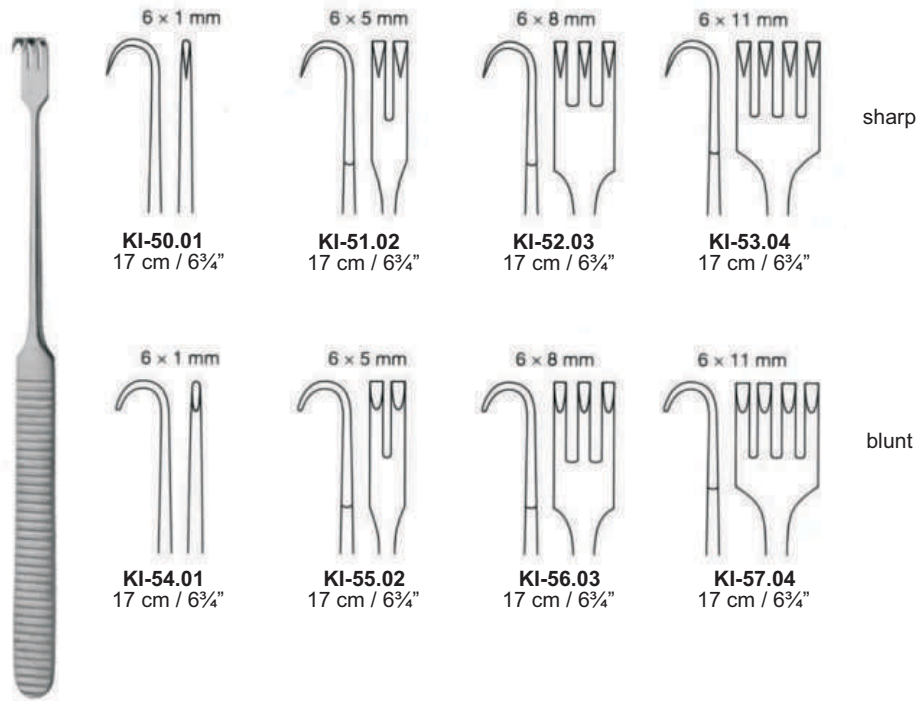

# DELICATE RETRACTORS



"Supporting Healthcare"  
**KAAHA INDUSTRIES**  
Manufacturer Of Dental & Surgical Instruments

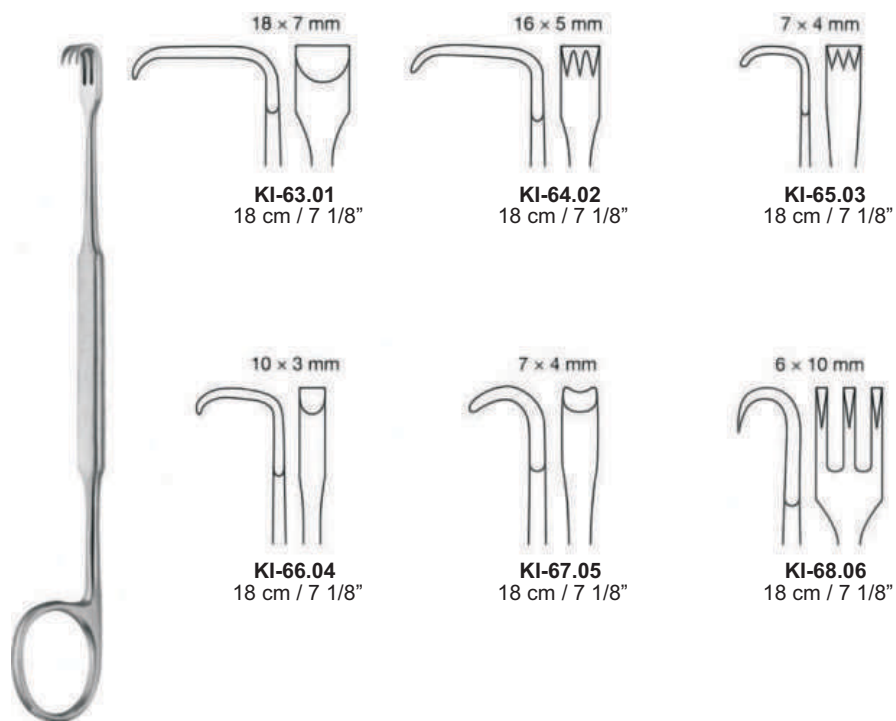

MEYERDING

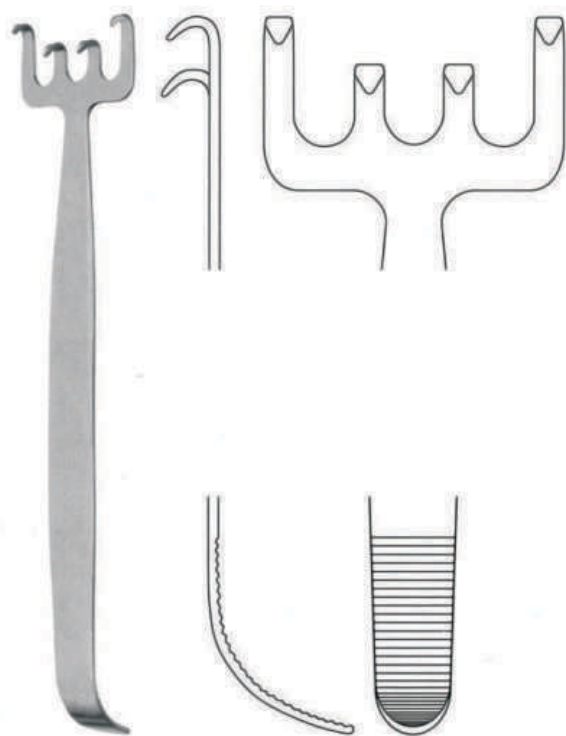

WALTER  
KI-69.39  
19 cm / 7½"

# DELICATE RETRACTORS



"Supporting Healthcare"  
**KAAHA INDUSTRIES**  
Manufacturer Of Dental & Surgical Instruments

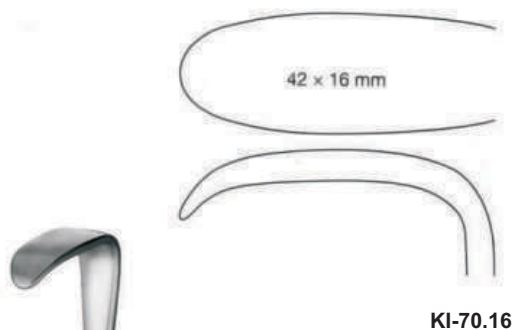

KI-70.16

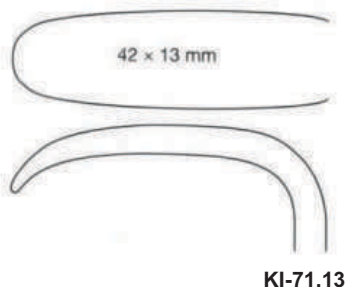

KI-71.13

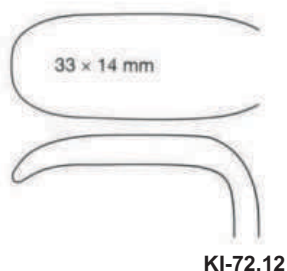

KI-72.12

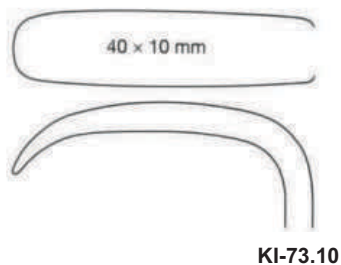

KI-73.10

KOCHER  
21 cm / 8¼"

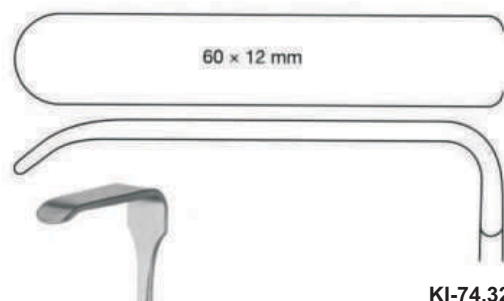

KI-74.32

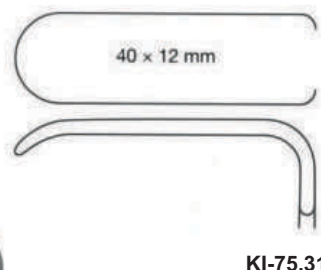

KI-75.31

KOCHER  
22 cm / 8¾"

# DELICATE RETRACTORS



"Supporting Healthcare"  
**KAAHA INDUSTRIES**  
 Manufacturer Of Dental & Surgical Instruments



DESMARES

Mandibular rim retractor  
 Separador para el borde del maxilar inferior  
 Ecarteur pour le bord du maxillaire inférieure  
 Divaricatore per il bordo della mascella inferiore



OBWEGESER  
**KI-81.17**  
 17 cm / 6¾"



OBWEGESER  
 22 cm / 8¾"

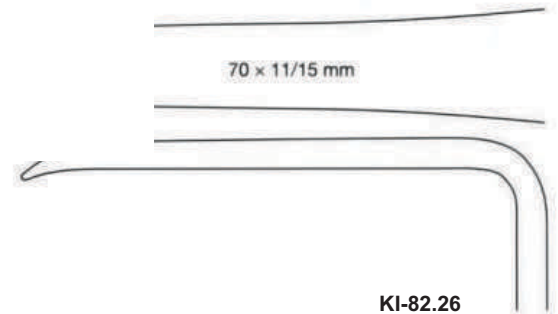

**KI-82.26**

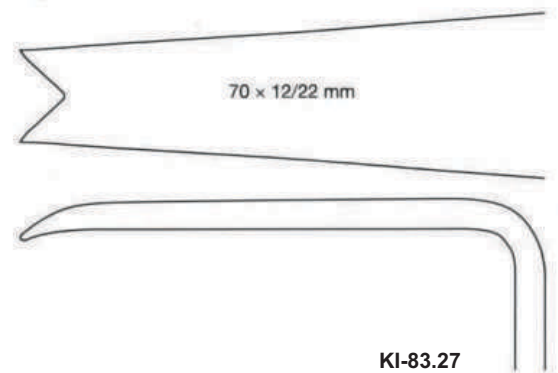

**KI-83.27**

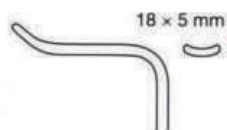

KI-84.31

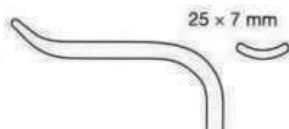

KI-85.32

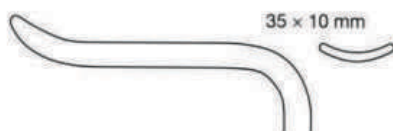

KI-86.33



KI-87.34



KI-88.35

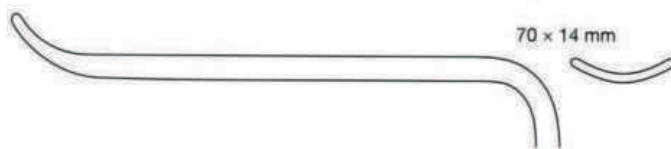

KI-89.36



KI-90.37



OBWEGESER  
23 cm / 9"

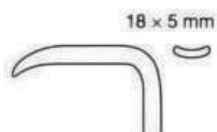

KI-91.41

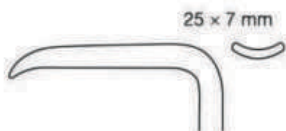

KI-92.42

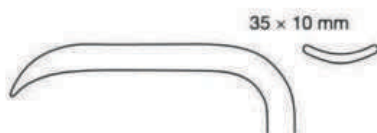

KI-93.43



KI-94.44



KI-95.45



KI-96.46

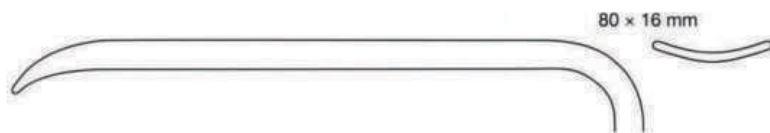

KI-97.47



OBWEGESER  
22.5 cm / 9"





OBWEGESER

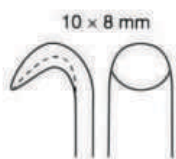

**KI-98.26**  
17.5 cm / 7"

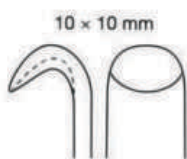

**KI-99.27**  
17.5 cm / 7"



OBWEGESER  
**KI-100.28**  
16 cm / 6 1/4"



DOYEN  
17 cm / 6 3/4"



**KI-101.11**  
right

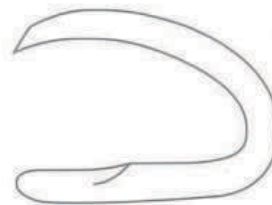

**KI-102.12**  
left

**Instruments for Auricular Plastic**  
 Instrumentos para la otoplastia  
 Instruments pour l'otoplastie  
 Strumenti per l'otoplastica



OBWEGESER

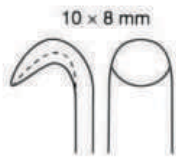

**KI-98.26**  
17.5 cm / 7"

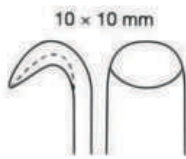

**KI-99.27**  
17.5 cm / 7"

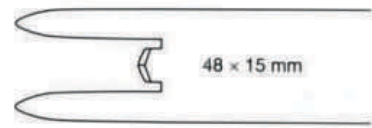

OBWEGESER  
**KI-100.28**  
16 cm / 6¼"



DOYEN  
17 cm / 6¾"



**KI-101.11**  
right



**KI-102.12**  
left

**Instruments for Auricular Plastic**  
 Instrumentos para la otoplastia  
 Instruments pour l'otoplastie  
 Strumenti per l'otoplastica

# SELF-RETAINING RETRACTORS



"Supporting Healthcare"  
**KAHA INDUSTRIES**  
 Manufacturer Of Dental & Surgical Instruments



**WEITLANER**  
**KI-617.13**  
 13 cm / 5 1/8"

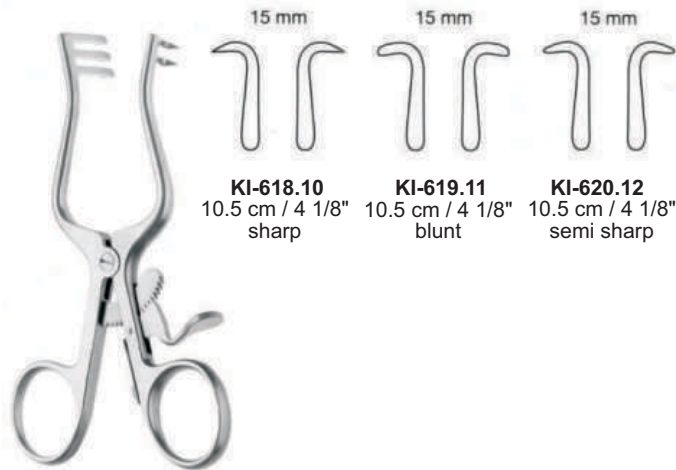

**KI-618.10** 10.5 cm / 4 1/8" sharp  
**KI-619.11** 10.5 cm / 4 1/8" blunt  
**KI-620.12** 10.5 cm / 4 1/8" semi sharp

**WEITLANER**

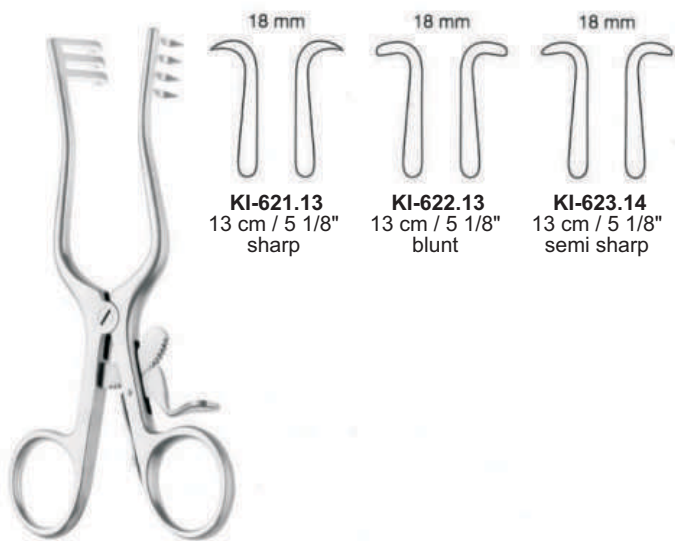

**KI-621.13** 13 cm / 5 1/8" sharp  
**KI-622.13** 13 cm / 5 1/8" blunt  
**KI-623.14** 13 cm / 5 1/8" semi sharp

**WEITLANER**

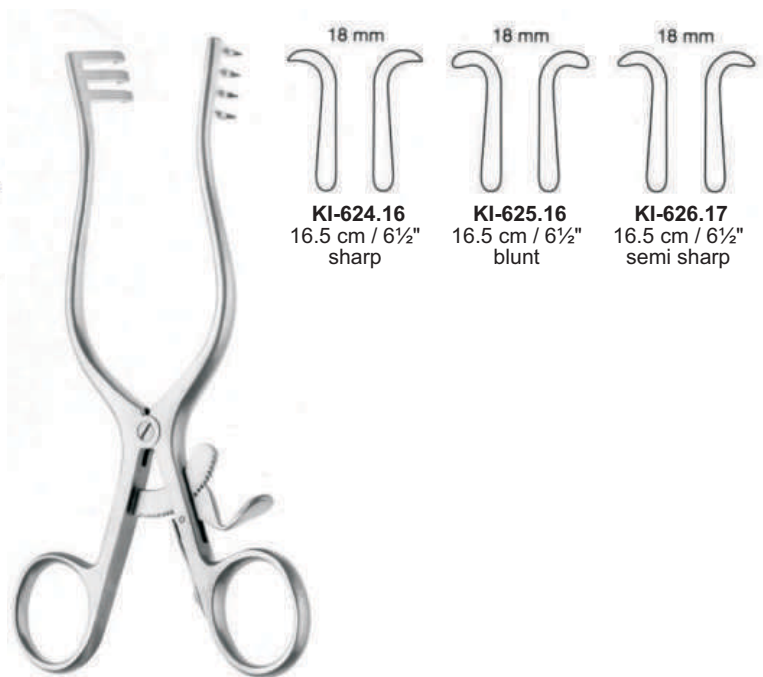

**KI-624.16** 16.5 cm / 6 1/2" sharp  
**KI-625.16** 16.5 cm / 6 1/2" blunt  
**KI-626.17** 16.5 cm / 6 1/2" semi sharp

**WEITLANER**

# NASAL DRESSING FORCECKI



"Supporting Healthcare"  
**KAAHA INDUSTRIES**  
Manufacturer Of Dental & Surgical Instruments



HARTMANN  
KI-70.16  
18 cm / 7 1/8"



HARTMANN  
KI-71.20  
20 cm / 8"



WESTMACOTT  
20 cm / 8"



KI-72.20



KI-73.21



LUBET BARBON  
KI-74.30  
20 cm / 8"

# NASAL DRESSING FORCECKI



"Supporting Healthcare"  
**KAAHA INDUSTRIES**  
Manufacturer Of Dental & Surgical Instruments



KI-75.11



KI-76.12

LUC BRUNINGS  
(HEYMANN)  
18 cm / 7 1/8"



CRAIG  
KI-79.15  
17 cm / 6 3/4"



KI-77.16



KI-78.17

CRAIG DOMNICK  
17 cm / 6 3/4"



HEYMANN  
KI-80.75  
18 cm / 7 1/8"



**JANSEN MIDDLETON SEPTUM FORCEKI, 19CM**

**KI-81.19**  
19 cm / 7 1/2"



**TILLY FORCEKI**

**KID F-82-35**  
17 cm / 6<sup>3</sup>/<sub>4</sub>"

# NASAL SEPTUM FORCEKI



"Supporting Healthcare"  
**KAAHA INDUSTRIES**  
Manufacturer Of Dental & Surgical Instruments



ASCH  
KI-90.21  
22 cm / 8¾"



COTTLE FOMON  
KI-92.24  
21 cm / 8¼"



WALSHAM "UNIVERSAL"  
KI-91.21  
23 cm / 9"



KI-93.22  
23 cm / 9"

KI-94.23  
23 cm / 9"

WALSHAM

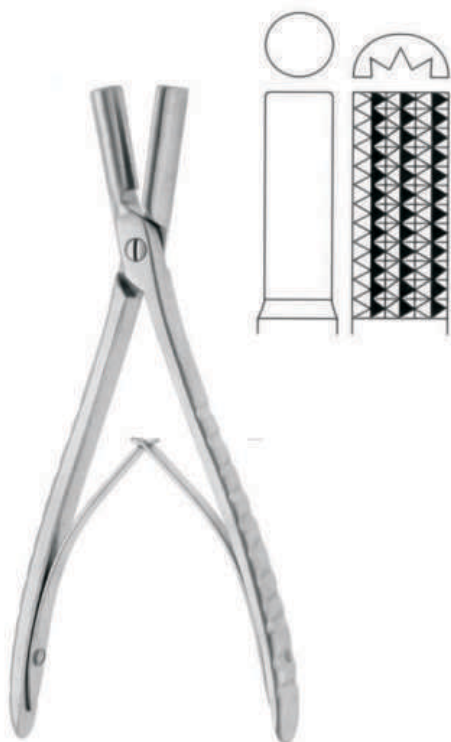

OBWEGESER  
KI-50.35  
17.5 cm / 7"



OBWEGESER  
KI-51.36  
17.5 cm / 7"

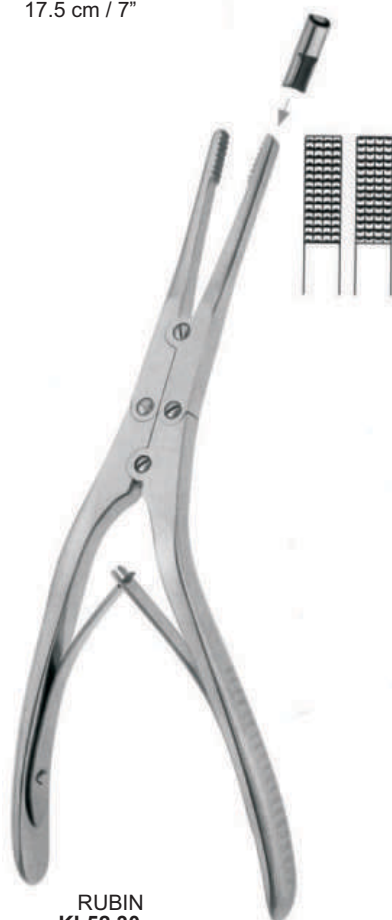









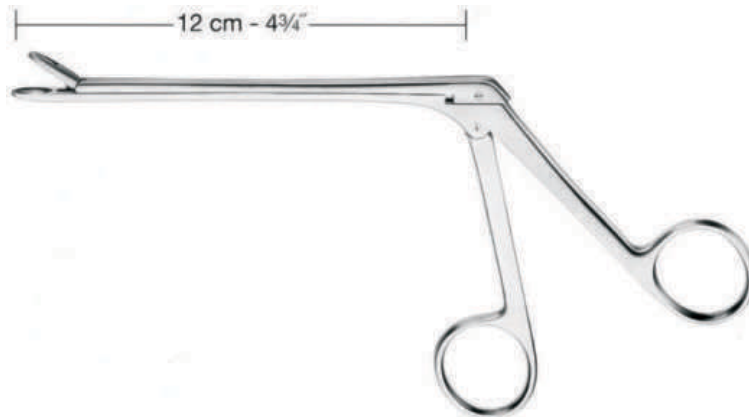

RUBIN  
KI-52.30  
20 cm / 8"



RUBIN  
KI-53.72  
20 cm / 8"





		straight	angled upwards 45°	angled upwards 90°
with normal shaft	3,0 mm 	KI-600.01	KI-605.11	KI-610.11
	3,6 mm 	KI-601.02	KI-606.12	KI-611.12
	4,2 mm 	KI-602.03	KI-607.13	KI-612.13
	4,8 mm 	KI-603.04	KI-608.14	KI-613.14
	5,6 mm 	KI-604.05	KI-609.15	KI-614.15
with slim shaft	3,0 mm 	KI-615.71	KI-620.81	
	3,6 mm 	KI-616.72	KI-621.82	
	4,2 mm 	KI-617.73	KI-622.83	
	4,8 mm 	KI-618.74	KI-623.84	
	5,6 mm 	KI-619.75	KI-624.85	

11,5 cm - 4½"



6WEIL BLAKESLEY



KI-625.25



KI-626.27



KI-627.28

straight



angled upwards

45°



KI-628.35

KI-629.76

KI-630.37

11,5 cm - 4½"



BLAKESLEY

straight



KI-631.59

angled upwards



KI-632.60

angled upwards



KI-633.61



# NASAL RETRACTORS



"Supporting Healthcare"  
**KAAHA INDUSTRIES**  
 Manufacturer Of Dental & Surgical Instruments



FOMON  
 KI-700.17  
 17 cm / 6 3/4"



NEIVERT  
 KI-701.19  
 19 cm / 7 1/2"

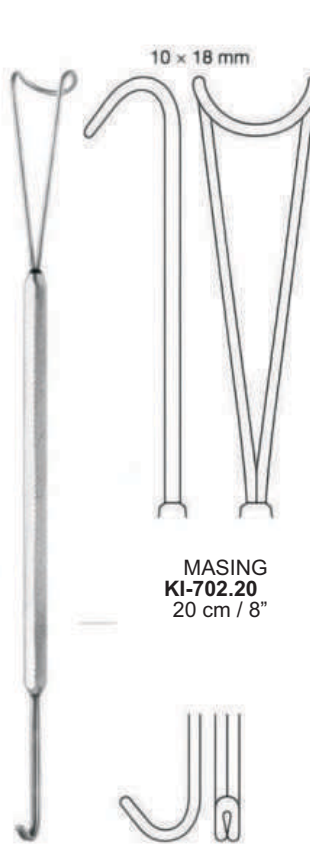

MASING  
 KI-702.20  
 20 cm / 8"



COTTLE NEIVERT  
 KI-703.21  
 21 cm / 8 1/4"

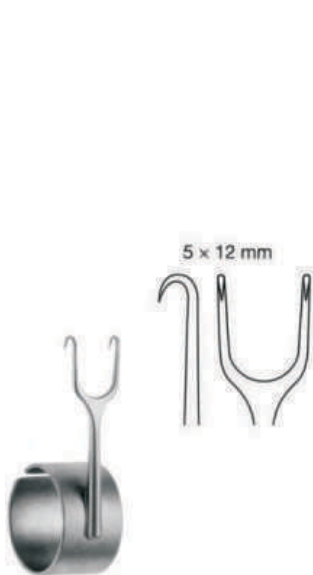

MILARD (COTTLE)  
 KI-704.23  
 5.5 cm / 2 1/8"



COTTLE  
 KI-705.44  
 15 cm / 6"



KI-706.16



KI-707.16



KI-708.16

# NASAL RETRACTORS



"Supporting Healthcare"  
**KAAHA INDUSTRIES**  
 Manufacturer Of Dental & Surgical Instruments



**COTTLE**  
**KI-709.44**  
 15 cm / 6"

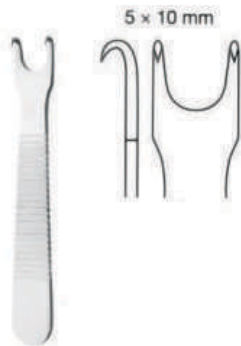

**KILNER**  
**KI-710.46**  
 10 cm / 4"



**COTTLE**  
**KI-711.48**  
 14 cm / 5½"

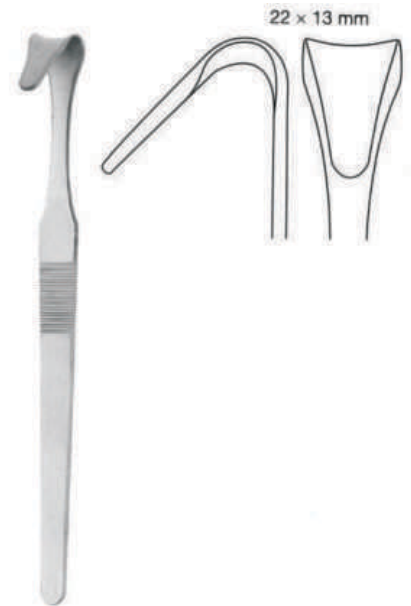

**COTTLE**  
**KI-712.50**  
 15 cm / 6"



**KI-713.60**

**AUFRICHT WALTER**  
 13.5 cm / 5 3/8"



5 x 9 mm



**KI-714.70**



8 x 9 mm



**AUFRICHT**  
**KI-715.80**  
 13.5 cm / 5 3/8"

13 x 9 mm

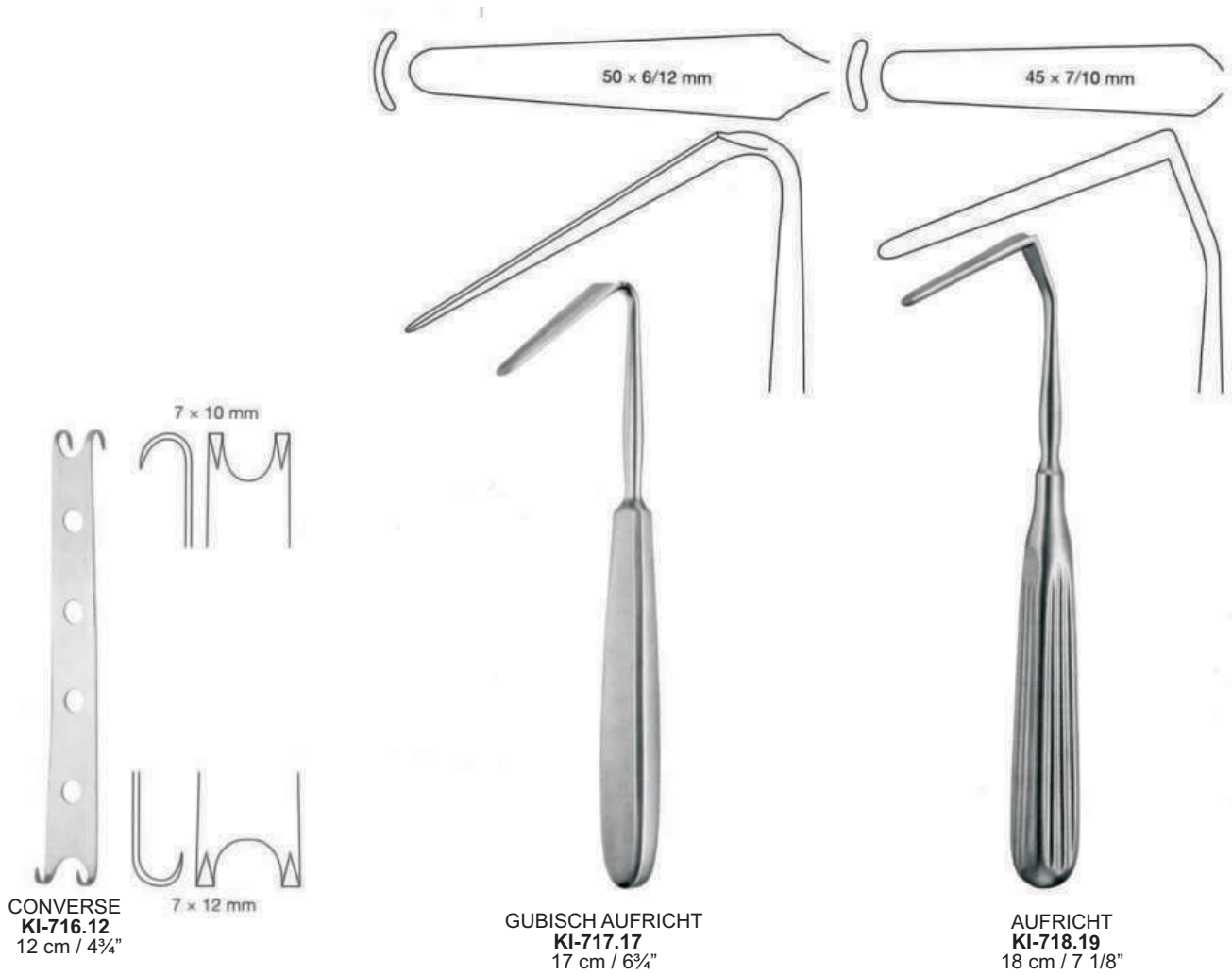

**Aufricht Nasal Retractor 18cm, 45×7-10mm**

KI-719.12

# NASAL SPECULUM



"Supporting Healthcare"  
**KAAHA INDUSTRIES**  
 Manufacturer Of Dental & Surgical Instruments



HARTMANN



**KI-720.15**  
15 cm / 6"

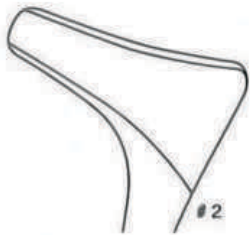

**KI-721.16**  
15 cm / 6"

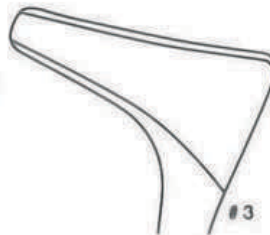

**KI-722.17**  
15 cm / 6"



TIECK HALLE



**KI-723.10**  
13.5 cm / 5 3/4"



**KI-724.11**  
13.5 cm / 5 3/4"

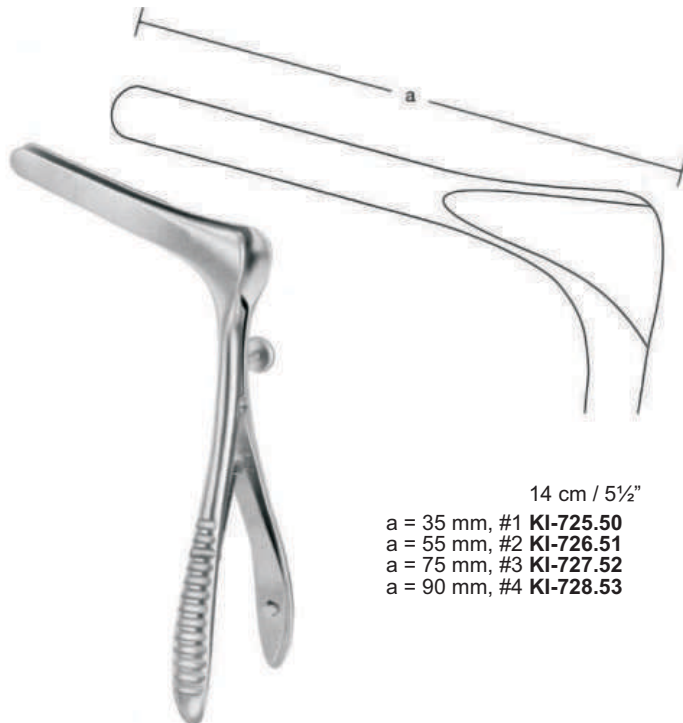

COTTLE

14 cm / 5 1/2"  
 a = 35 mm, #1 **KI-725.50**  
 a = 55 mm, #2 **KI-726.51**  
 a = 75 mm, #3 **KI-727.52**  
 a = 90 mm, #4 **KI-728.53**



COTTLE  
**KI-729.60**  
 14 cm / 5 1/2"



COTTLE  
**KI-730.62**  
 13 cm / 5 1/8"



"MOD. WIEN"



**KI-731.15**  
 14 cm / 5 1/2"

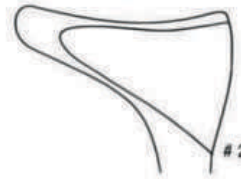

**KI-732.16**  
 14 cm / 5 1/2"

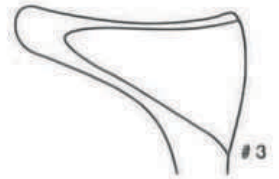

**KI-733.17**  
 14 cm / 5 1/2"



14 cm / 5 1/2"

- a = 35 mm, #1 **KI-734.14**
- a = 50 mm, #2 **KI-735.15**
- a = 75 mm, #3 **KI-736.16**
- a = 90 mm, #4 **KI-737.17**

KILLIAN

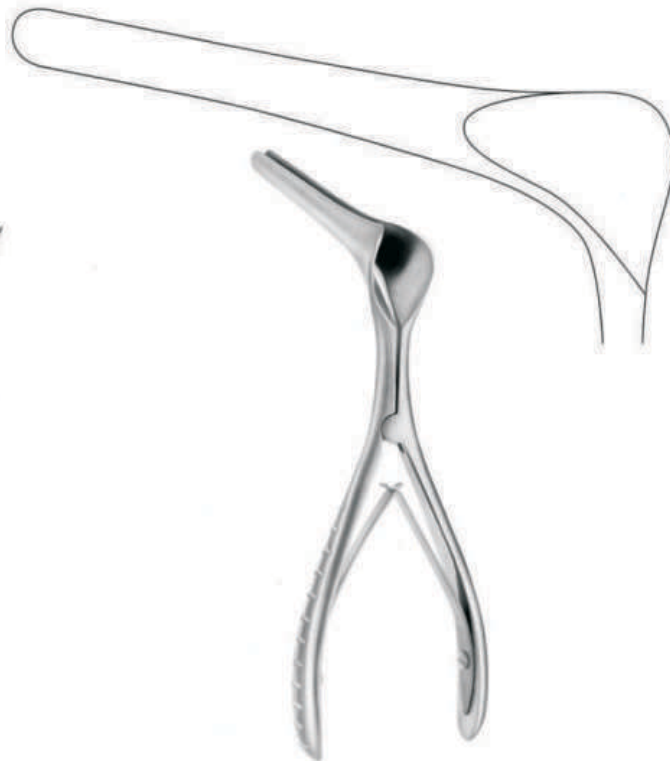

KILLIAN  
**KI-738.59**  
 14 cm / 5 1/2"



JOSEPH  
17 cm / 6 3/4"



KI-200.24  
left



KI-201.24  
right

**Nasal Saws**  
 Sierras nasales  
 Scies nasales  
 Seghe nasali



JOSEPH  
KI-202.24  
17 cm / 6 3/4"



COTTLE  
KI-203.24  
21 cm / 8 1/4"

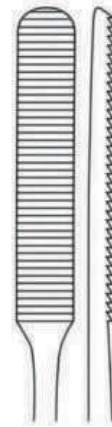

COTTLE  
KI-204.25  
20.5 cm / 8"



MALTZ  
KI-205.25  
18.5 cm / 7 1/4"

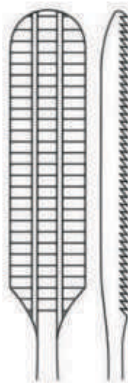

KI-206.47  
19.5 cm / 7 3/4"

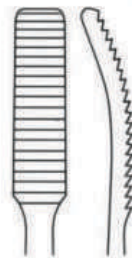

LEWIS  
KI-207.50  
19.5 cm / 7 3/4"

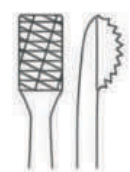





**KI-208.35**  
 15 cm / 6"  
 left



**KI-209.36**  
 15 cm / 6"  
 right

CARTILAGE ABRADERS  
**KI-210.37**  
 Set complete (#1+2)

DINGMAN



LEWIS  
**KI-211.26**  
 20 cm / 8"



KITLER



**KI-212.45**  
 16 cm / 6¼"



**KI-213.46**  
 16 cm / 6¼"

Anthelix Cartilage File for Auricular Plastic  
 Lima para el cartilago del anthelix para la otoplastia  
 Lime pour le cartilage de l'anthelix pour l'otoplastie  
 Lima per cartilagine del anthelix per l'otoplastica



AUFRICHT

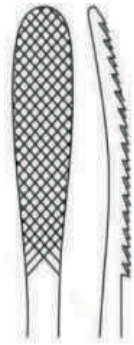

**KI-228.26**  
21 cm / 8¼"

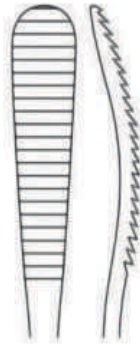

**KI-229.27**  
21 cm / 8¼"

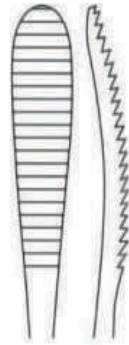

**KI-230.28**  
21 cm / 8¼"

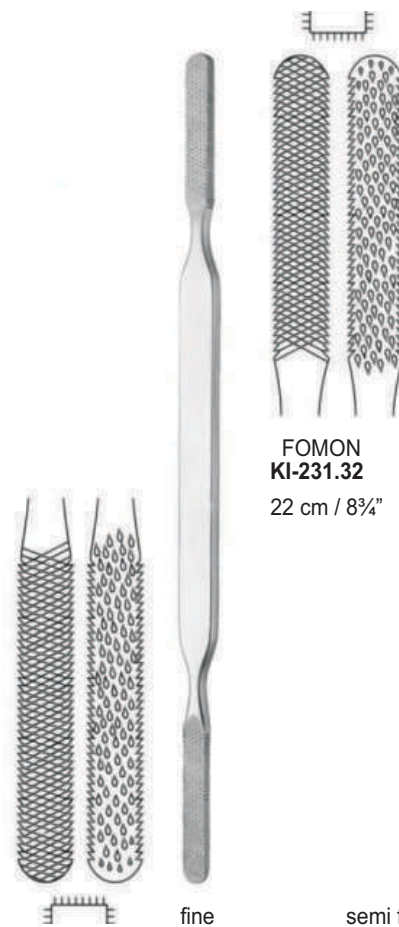

**FOMON**  
**KI-231.32**  
 22 cm / 8¾"

fine

semi fine



**OBWEGESER**  
19 cm / 7¾"

One working end of the rasp operates by pushing, the other by pulling.

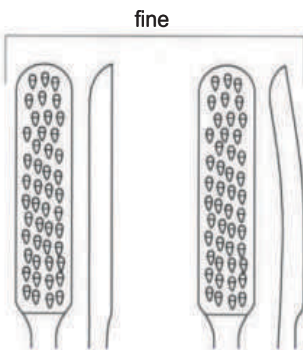

**KI-232.41**

**KI-233.43**

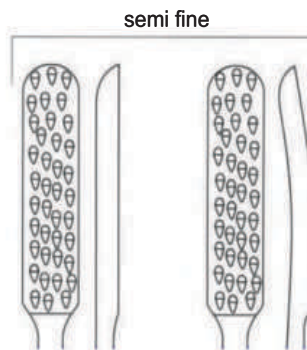

**KI-234.42**

**KI-235.44**



**OBWEGESER**  
19 cm / 7¾"

Bone splinters are pushed through the perforated working ends. This avoids plugging of the rasps and they can be cleaned easily.

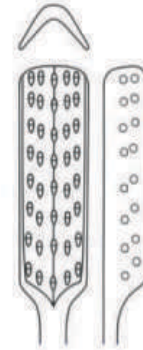

**KI-236.45**

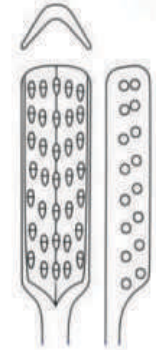

**KI-237.46**

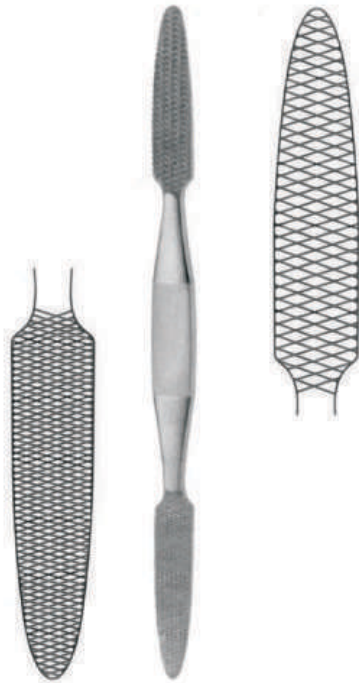

CONVERSE  
**KI-238.65**  
 18.5 cm / 7¼"



MASING  
**KI-239.70**  
 21 cm / 8¼"

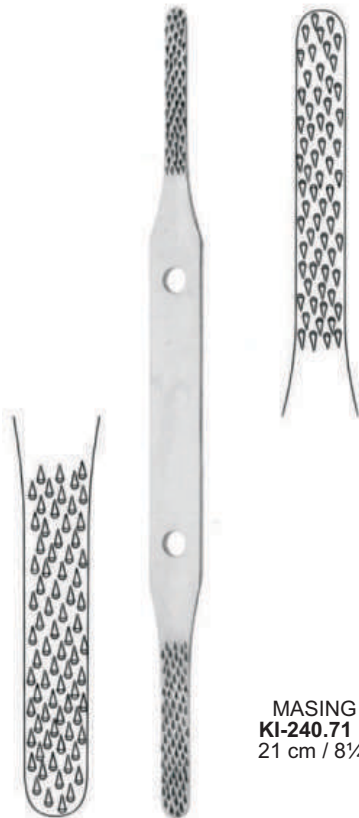

MASING  
**KI-240.71**  
 21 cm / 8¼"



GUBISCH FOMON  
**KI-241.30**  
 20 cm / 8"



**COTTLE**  
**KI-100.14**  
14 cm / 5½"



**COTTLE**  
**KI-102.14**  
14 cm / 5½"



**JOSEPH**  
**KI-103.16**  
16 cm / 6¼"



**CONVERSE**  
**KI-104.15**  
15 cm / 6"



**Ballanger Swivel Knife**  
19 cm  
**KI-105.19**



**Ballanger Swivel Knife, Bayonet**  
19 cm  
**KI-106.19**

# CHISELS & OSTEOTOMES



"Supporting Healthcare"  
**KAAHA INDUSTRIES**  
 Manufacturer Of Dental & Surgical Instruments



**COTTLE GUBISCH**  
 18 cm / 7 1/8"

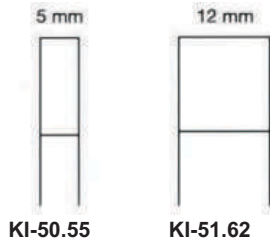

**COTTLE**  
 18 cm / 7 1/8"

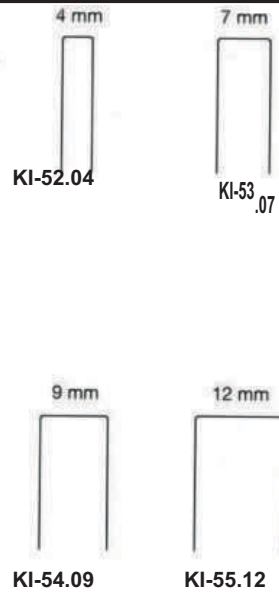

**COTTLE**  
**KI-56.16**  
 18 cm / 7 1/4"

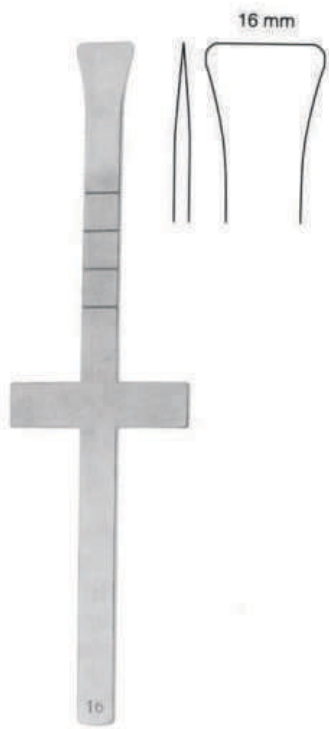

**COTTLE**  
**KI-57.20**  
 18 cm / 7 1/8"

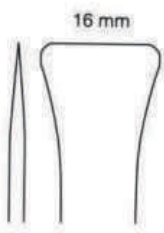

**COTTLE**  
 18 cm / 7 1/8"

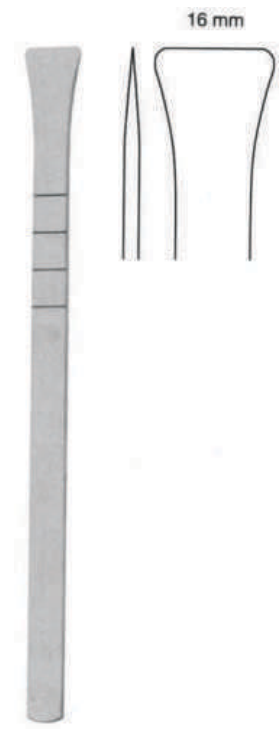
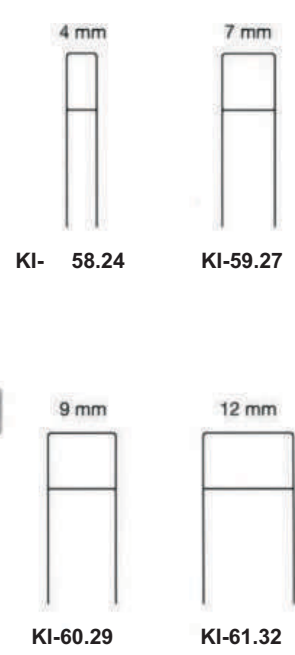

**COTTLE**  
**KI-62.38**  
 18 cm / 7 1/8"

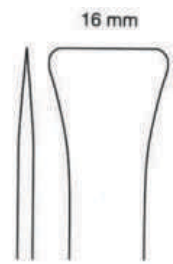

# CHISELS & OSTEOTOMES



"Supporting Healthcare"  
**KAAHA INDUSTRIES**  
 Manufacturer Of Dental & Surgical Instruments

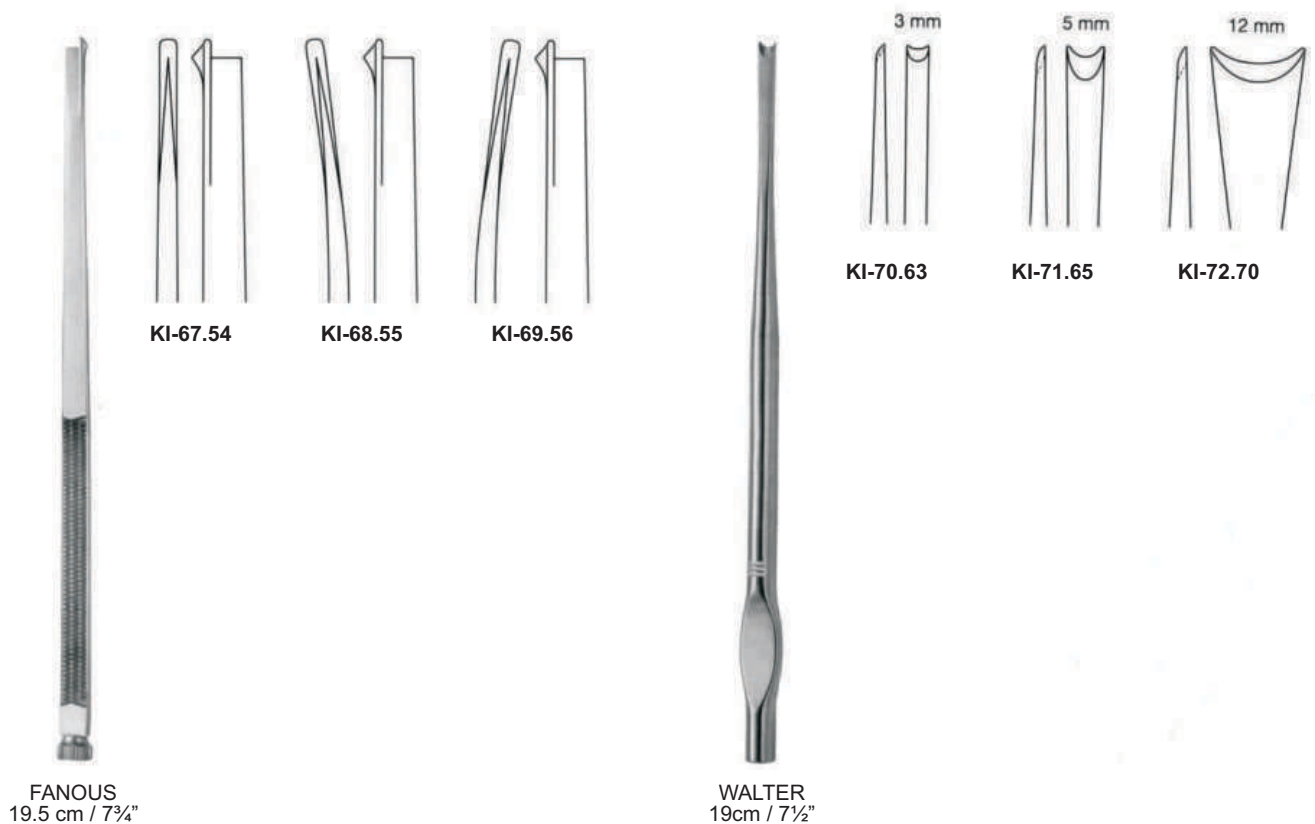
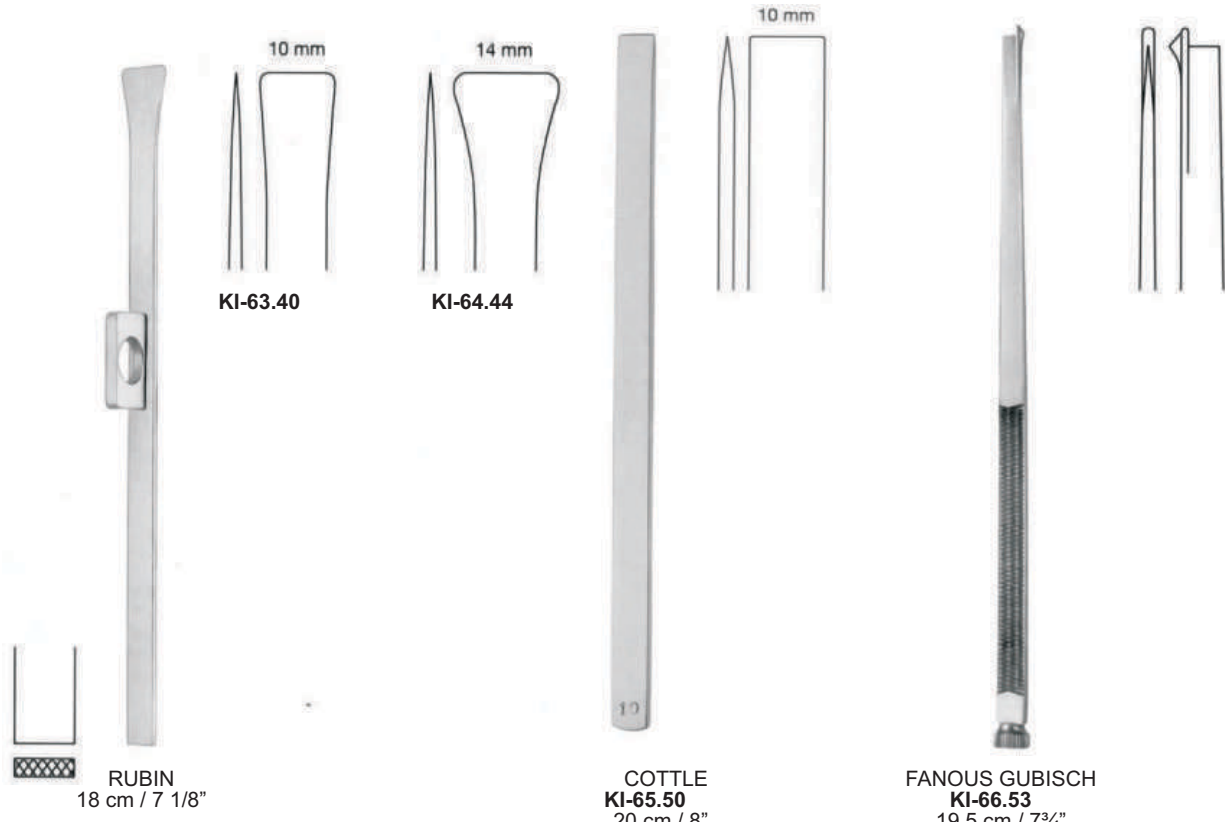

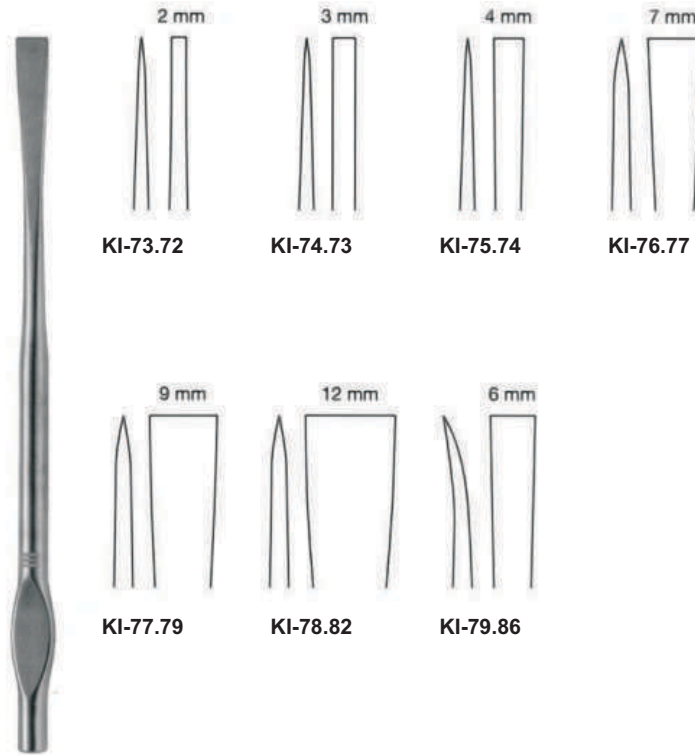

KI-73.72

KI-74.73

KI-75.74

KI-76.77

KI-77.79

KI-78.82

KI-79.86

WALTER  
 19cm / 7½"

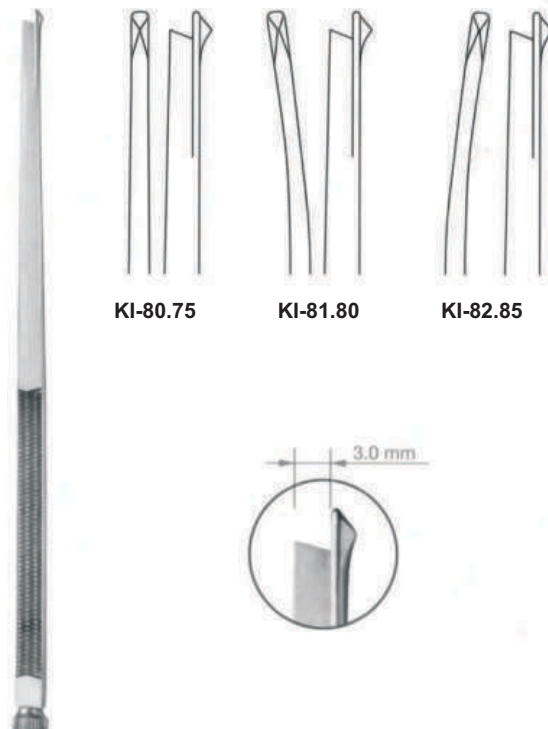

KI-80.75

KI-81.80

KI-82.85

SCHROM  
 19.5 cm / 7¾"

# CHISELS & OSTEOTOMES



"Supporting Healthcare"  
**KAAHA INDUSTRIES**  
 Manufacturer Of Dental & Surgical Instruments

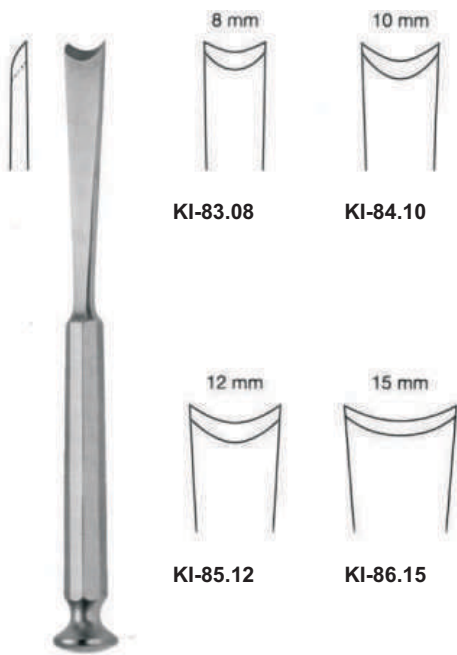

KI-83.08

KI-84.10

KI-85.12

KI-86.15

MCINDOE  
 16 cm / 6 1/4"

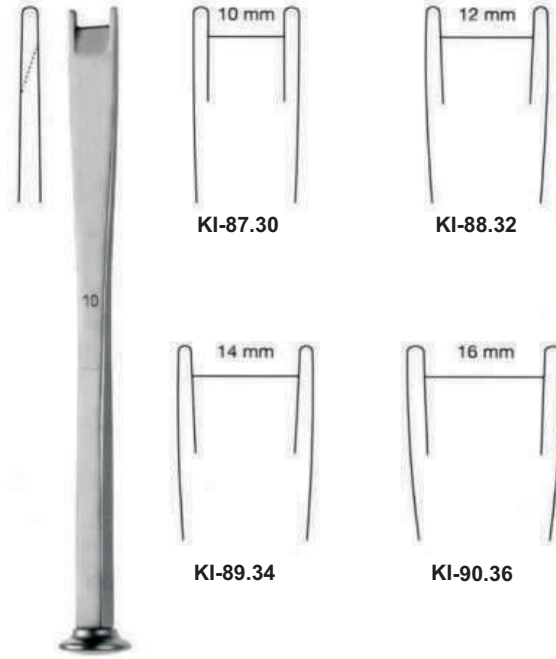

KI-87.30

KI-88.32

KI-89.34

KI-90.36

MOBERG  
 18 cm / 7 1/8"

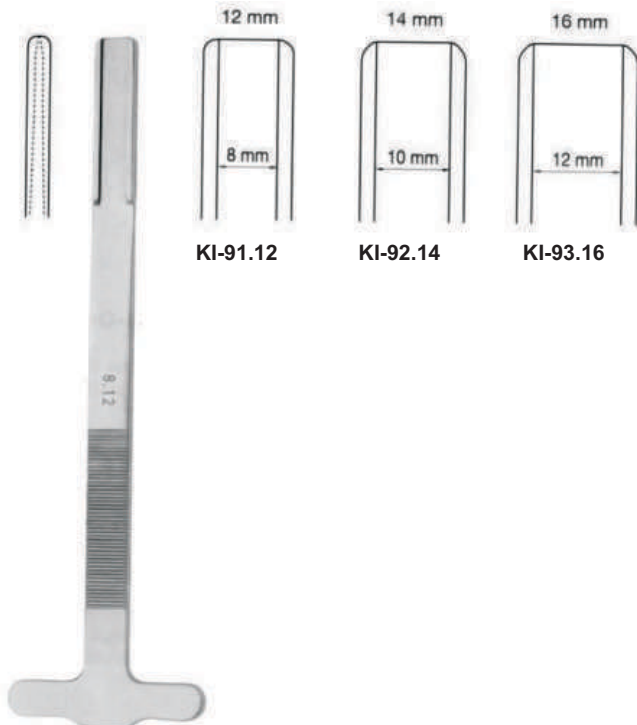

KI-91.12

KI-92.14

KI-93.16

RUBIN  
 19 cm / 7 1/2"

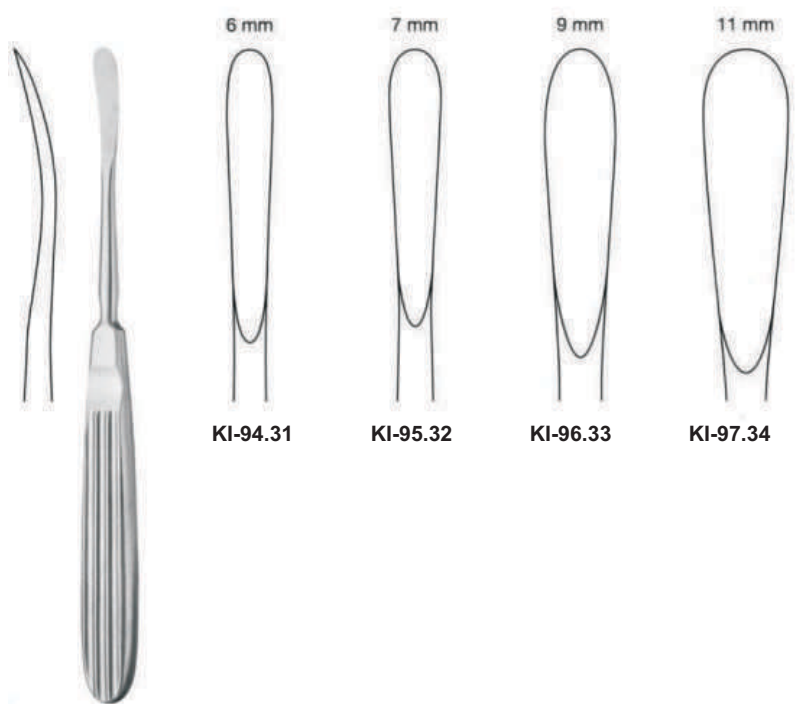

KI-94.31

KI-95.32

KI-96.33

KI-97.34

OBWEGESER  
 17.5 cm / 7"



# CHISELS & OSTEOTOMES



"Supporting Healthcare"  
**KAAHA INDUSTRIES**  
 Manufacturer Of Dental & Surgical Instruments



FOMON



**KI-98.17**  
17 cm / 6 3/4"



**KI-99.19**  
17 cm / 6 3/4"



**KI-100.20**  
17 cm / 6 3/4"



SILVER  
18 cm / 7 1/8"



**KI-101.01**



**KI-102.02**

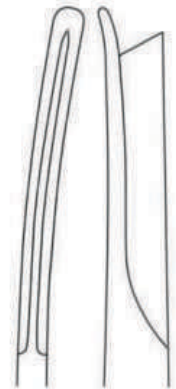

**KI-103.03**



CINELLI  
16 cm / 6 1/4"



**KI-104.10**



**KI-105.12**



**KI-106.14**



**KI-107.16**



BLUME  
**KI-108.20**  
 18 cm / 7 1/8"

# CHISELS & OSTEOTOMES



"Supporting Healthcare"  
**KAAHA INDUSTRIES**  
 Manufacturer Of Dental & Surgical Instruments



GUBISCH  
 KI-109.53  
 18.5 cm / 7¼"



OBWEGESER  
 15 cm / 6"



KI-110.02



KI-111.04



KI-112.39



OBWEGESER  
 22 cm / 8¾"

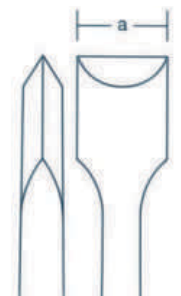

a = 8 mm  
 a = 12 mm  
 a = 16 mm

KI-113.12  
 KI-114.13  
 KI-115.14



OBWEGESER  
 21.5 cm / 8½"

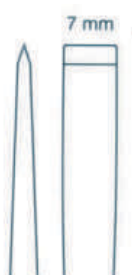

KI-116.07

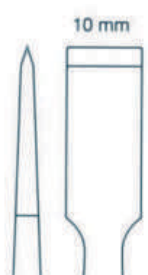

KI-117.10



OBWEGESER  
 22 cm / 8¾"

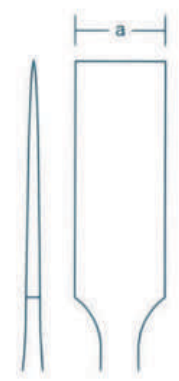

a = 8 mm  
 a = 12 mm  
 a = 16 mm  
 a = 20mm

KI-118.16  
 KI-119.17  
 KI-120.18  
 KI-121.20

# CHISELS & OSTEOTOMES



"Supporting Healthcare"  
**KAAHA INDUSTRIES**  
 Manufacturer Of Dental & Surgical Instruments



**OBWEGESER**  
**KI-122.30**  
 23.5 cm / 9 1/4"



**KI-123.34**



**KI-124.35**



- a = 10 mm
- a = 15 mm
- a = 20 mm
- a = 30 mm

**TESSIER**  
 20.5 cm / 8"

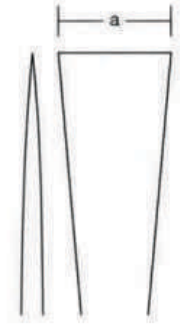

- KI-125.50**
- KI-126.52**
- KI-127.54**
- KI-128.56**

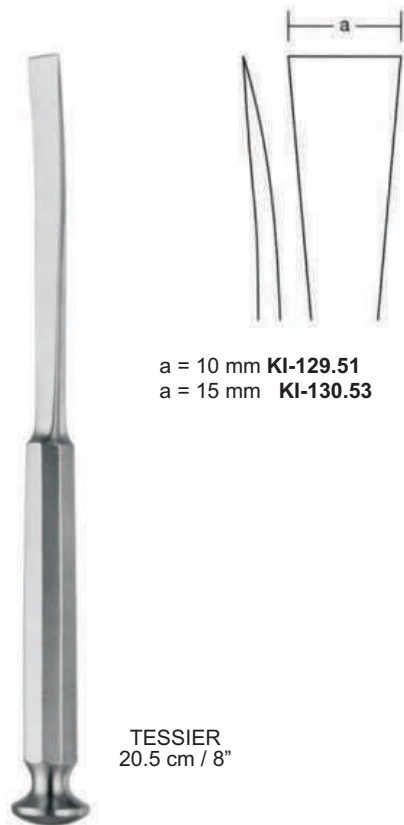

- a = 10 mm **KI-129.51**
- a = 15 mm **KI-130.53**

**TESSIER**  
 20.5 cm / 8"



**KI-131.60**



**KI-132.61**

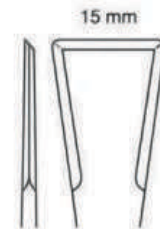

**KI-133.62**

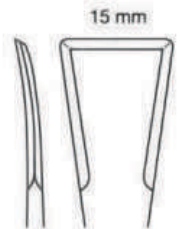

**KI-134.63**

**TESSIER**  
 16 cm / 6 1/4"

# CHISELS & OSTEOTOMES



"Supporting Healthcare"  
**KAAHA INDUSTRIES**  
 Manufacturer Of Dental & Surgical Instruments



**OBWEGESER**  
**KI-135.29**  
 11 cm / 9"

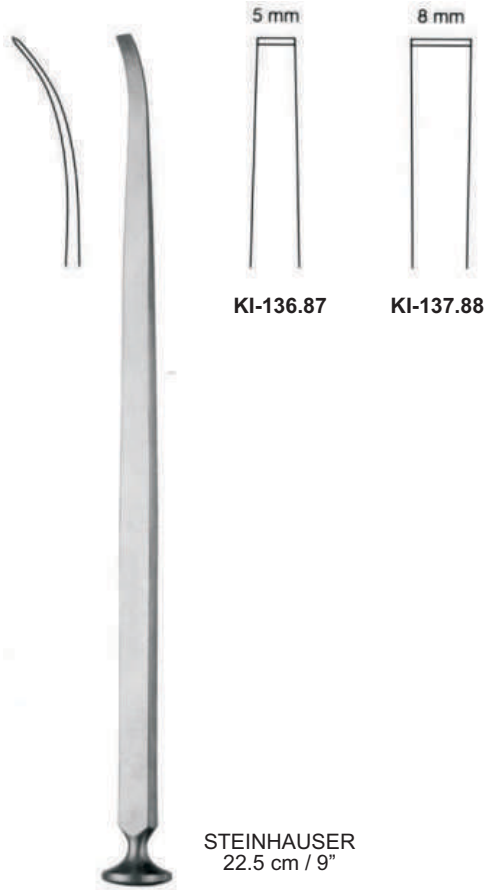

**STEINHAUSER**  
 22.5 cm / 9"



**OBWEGESER**  
 18.5 cm / 7 1/4"

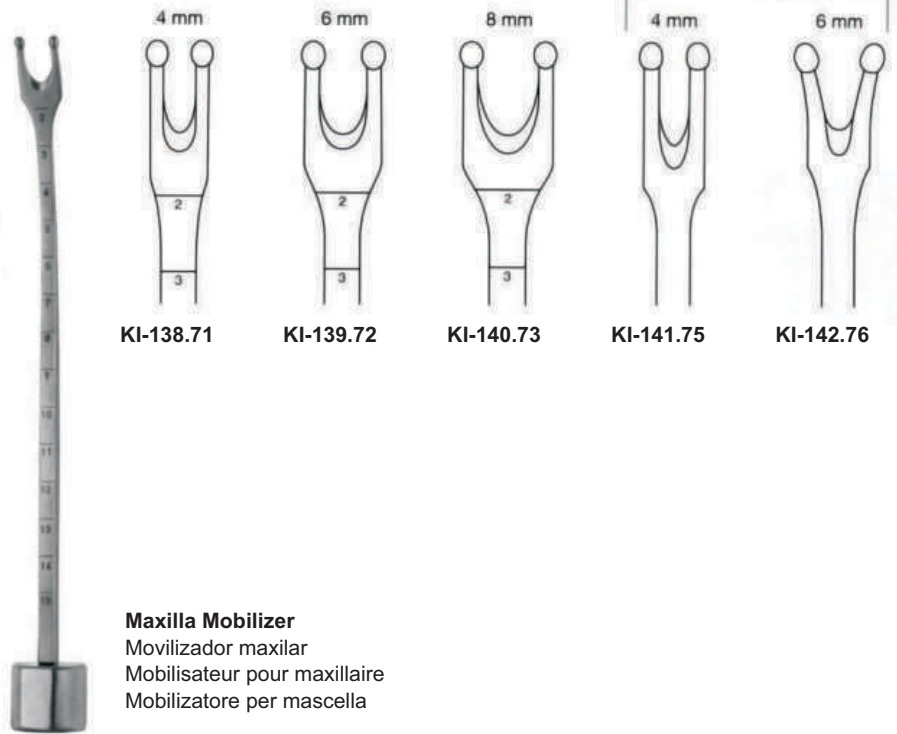

**Maxilla Mobilizer**  
 Movilizador maxilar  
 Mobilisateur pour maxillaire  
 Mobilizzatore per mascella

# CHISELS & ELEVATORS



"Supporting Healthcare"  
**KAAHA INDUSTRIES**  
 Manufacturer Of Dental & Surgical Instruments

**Mucosa knife**  
 Cuchillo para mucosa  
 Septotome  
 Cotello per mucosa



**FREER**  
**KI-200.16**  
 16 cm / 6 1/4"



**BALLENGER**  
 16 cm / 6 1/4"



**FREER**  
 15.5 cm / 6 1/8"



**KILLIAN**  
**KI-205.46**  
 17.5 cm / 7"



**KILLIAN CLAUS**  
**KI-206.47**  
 17 cm / 6 3/4"



**KI-207.50**  
 20 cm / 8"

# CHISELS & ELEVATORS



"Supporting Healthcare"  
**KAAHA INDUSTRIES**  
 Manufacturer Of Dental & Surgical Instruments

**Mucosa knife**  
 Cuchillo para mucosa  
 Septotome  
 Cotello per mucosa



**FREER**  
**KI-200.16**  
 16 cm / 6 1/4"



**BALLENGER**  
 16 cm / 6 1/4"



**FREER**  
 15.5 cm / 6 1/8"



**KILLIAN**  
**KI-205.46**  
 17.5 cm / 7"



**KILLIAN CLAUS**  
**KI-206.47**  
 17 cm / 6 3/4"



**KI-207.50**  
 20 cm / 8"





**KI-600.65**    **KI-601.66**  
 30 cm / 11 $\frac{3}{4}$ "    30 cm / 11 $\frac{3}{4}$ "



OBWEGESER

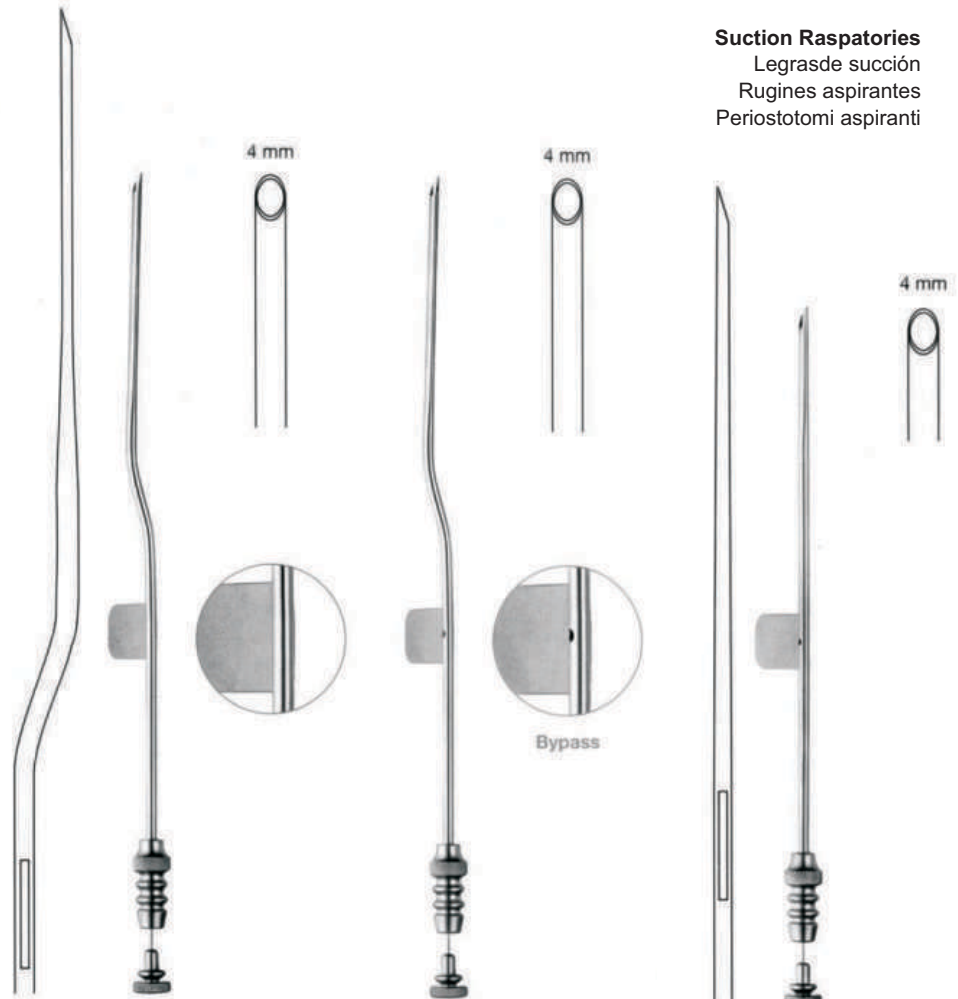

**Suction Raspatories**  
 Legrasde succión  
 Rugines aspirantes  
 Periototomi aspiranti

**KI-602.93**  
 20 cm / 8"

**GUBISCH**  
**KI-603.94**  
 20 cm / 8"

**GUBISCH**  
**KI-604.97**  
 17cm / 6 $\frac{3}{4}$ "



**COTTLE**  
**KI-605.19**  
 18 cm / 7 1/8"



**COTTLE**  
**KI-606.20**  
 18 cm / 7 1/8"



**JOSEPH MASING**  
**KI-607.48**  
 22 cm / 8 3/4"



**KI-608.55**  
 18 cm / 7 1/8"



**KI-609.60**  
 17 cm / 6 3/4"



**CONVERSE**  
**KI-610.65**  
 18 cm / 7 1/8"



**BOIES**  
**KI-611.69**  
 19 cm / 7 1/2"



**GOLDMAN**  
**KI-612.75**  
 17 cm / 6 3/4"

**Elevators**  
 Elevadores  
 Elevateurs  
 Elevatori



**Mucosa knife and Raspatories**  
 Cuchillo para mucosa y legbras  
 Septotome et rugines  
 Cotello per mucosa e periostotomi

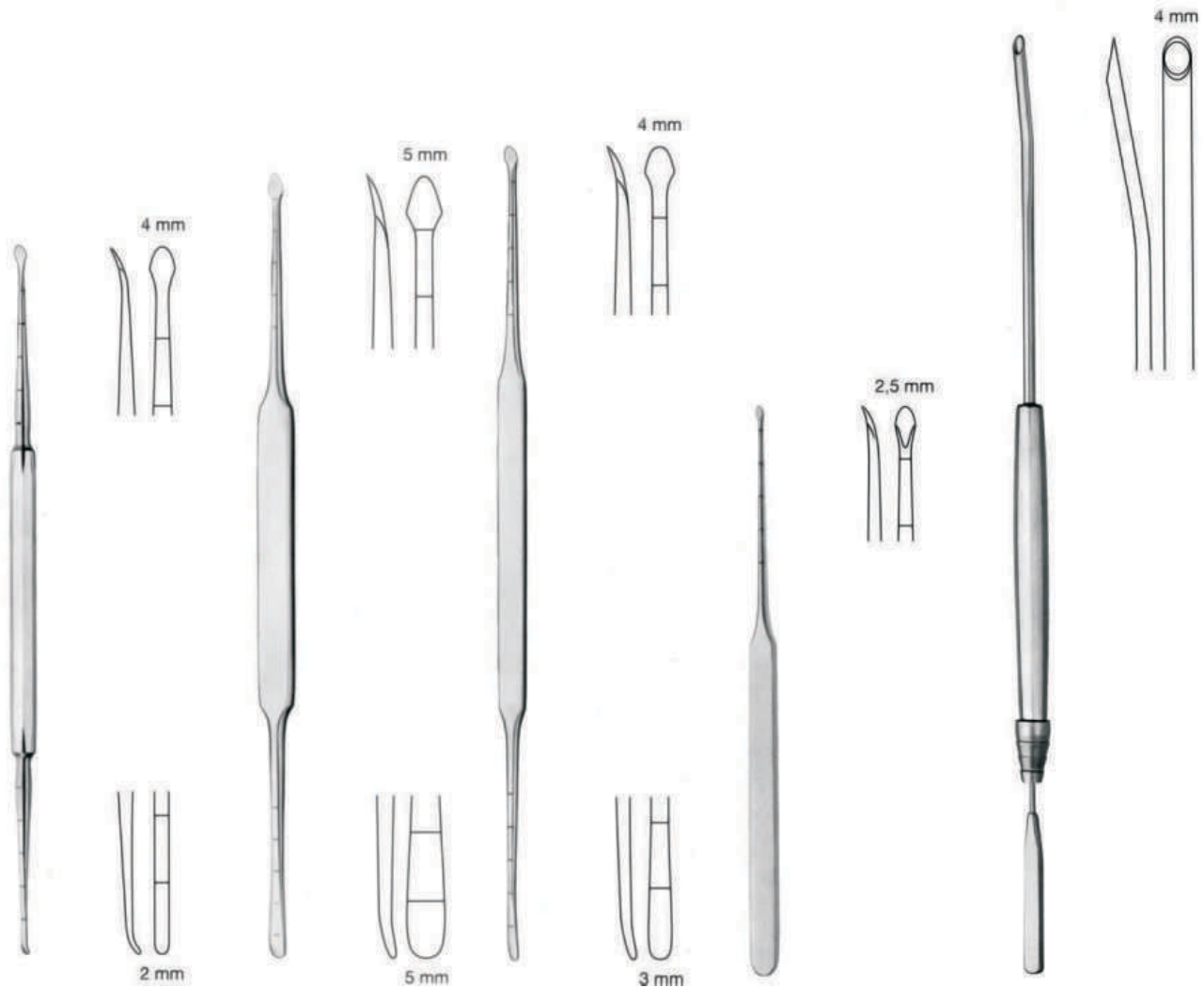

COTTLE  
**KI-613.20**  
 20 cm / 8"

MASING  
**KI-614.22**  
 22 cm / 8<sup>3</sup>/<sub>4</sub>"

MASING  
**KI-615.23**  
 23 cm / 9"

COTTLE  
**KI-616.12**  
 16 cm / 6<sup>1</sup>/<sub>4</sub>"

**KI-617.21**  
 21 cm / 8<sup>1</sup>/<sub>4</sub>"

**Elevators**  
Elevadores  
Elévateurs  
Elevatori



# RASPATORIES & ELEVATORS



"Supporting Healthcare"  
**KAAHA INDUSTRIES**  
 Manufacturer Of Dental & Surgical Instruments

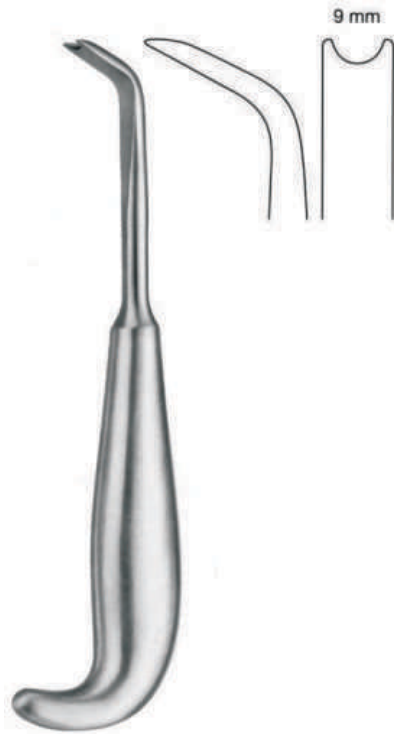

HARGIS  
**KI-621.35**  
 19 cm / 7½"



OBWEGESER  
**KI-622.36**  
 18 cm / 7 1/8"



**KI-622.36**



**KI-623.37**



OBWEGESER  
**KI-624.38**  
 17.5 cm / 7"



OBWEGESER  
**KI-625.39**  
 17.5 cm / 7"

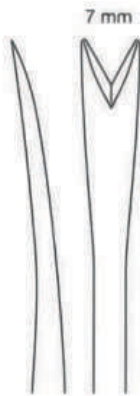

**KI-625.39**

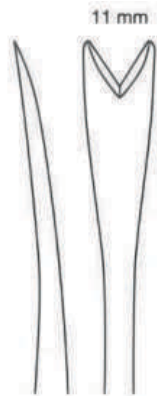

**KI-626.40**



OBWEGESER  
**KI-627.41**  
 20 cm / 8"



**KI-627.41**

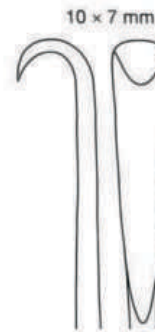

**KI-628.42**

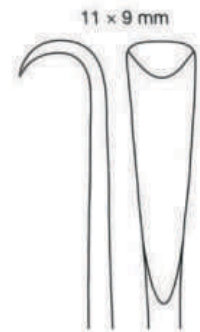

**KI-629.43**

# RASPATORIES & ELEVATORS



"Supporting Healthcare"  
**KAAHA INDUSTRIES**  
 Manufacturer Of Dental & Surgical Instruments

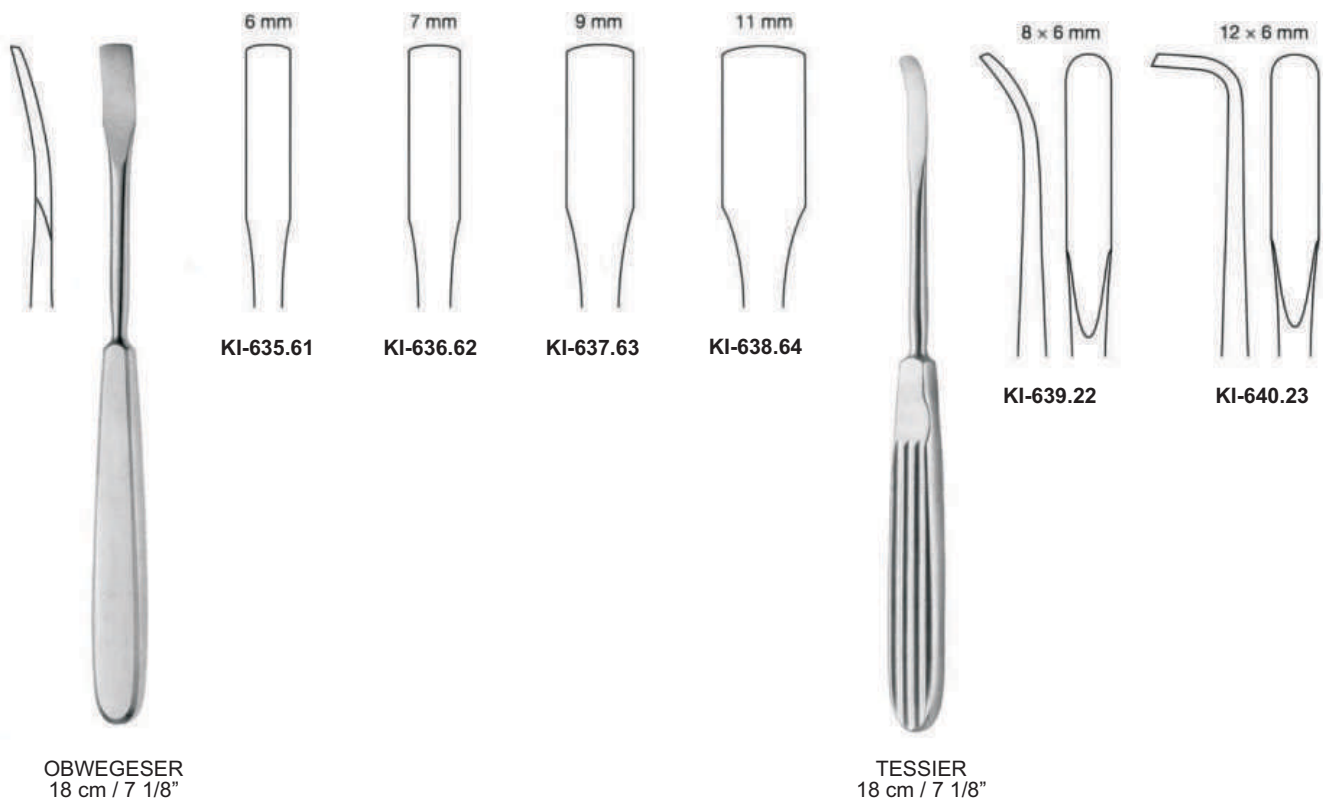
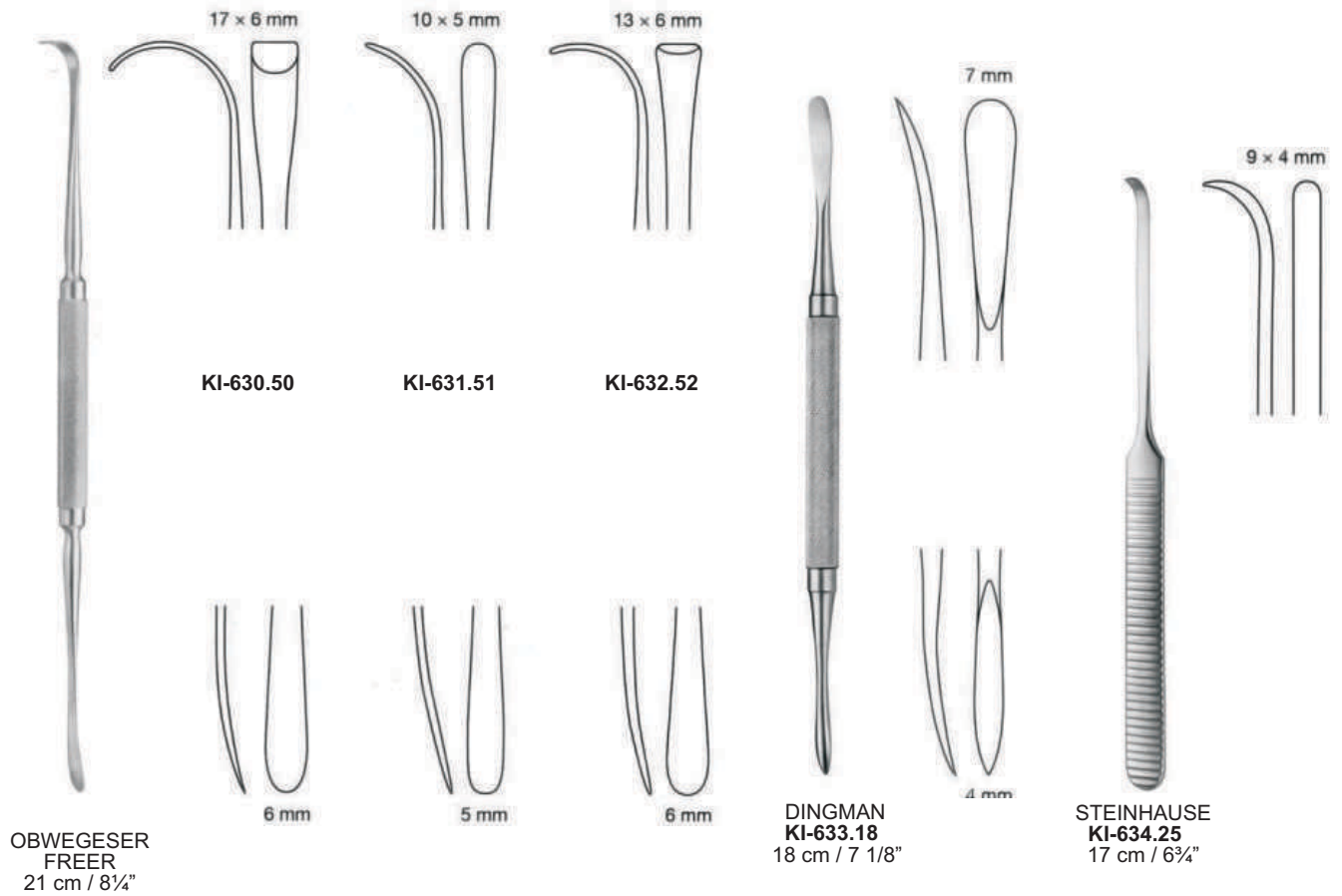

# RASPATORIES & ELEVATORS



"Supporting Healthcare"  
**KAAHA INDUSTRIES**  
 Manufacturer Of Dental & Surgical Instruments



KI-641.03

KI-642.05

25 cm / 10"

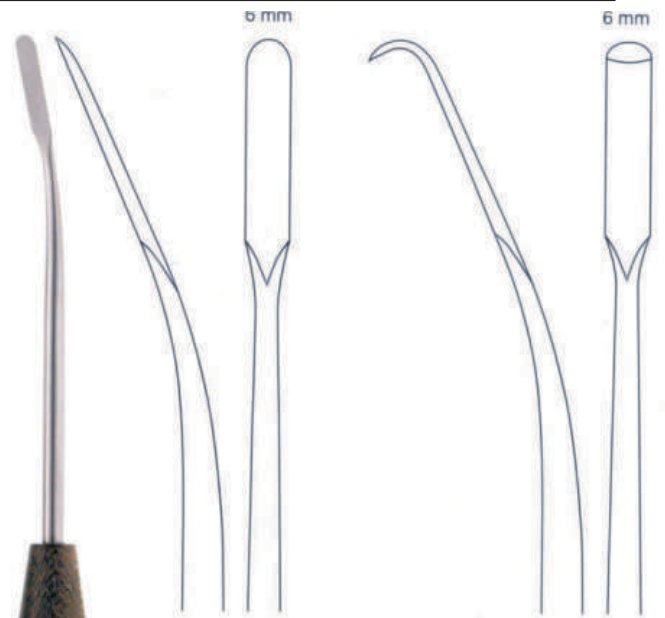

KI-643.04

KI-644.06



6 mm

stumpf  
 blunt  
 romo  
 mousse  
 smussa

25 cm / 10"

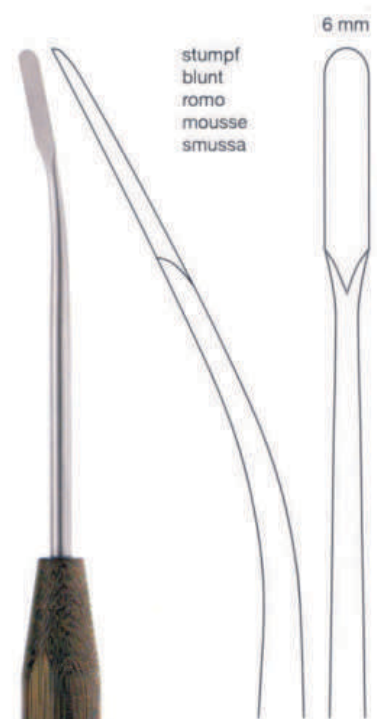

6 mm

stumpf  
 blunt  
 romo  
 mousse  
 smussa

KI-646.09  
 25 cm / 10"

KI-645.08  
 25 cm / 10"

**Dissectors**  
 Disectores  
 Dissecteurs  
 Dissettori



**KI-647.11**  
20 cm / 8"



**KI-648.12**  
20 cm / 8"



9 mm

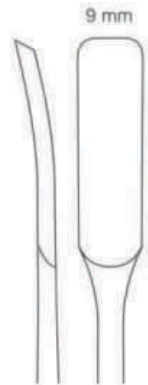

9 mm



a = 7 cm - 2¾"  
**KI-649.07**

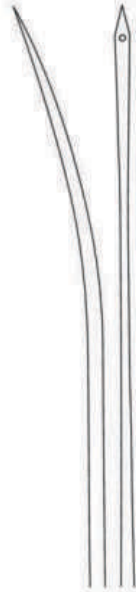

a = 12 cm - 4¾"  
**KI-650.12**



**KI-651.43**  
27 cm / 10"

**Elevators**  
 Elevadores  
 Élévateurs  
 Elevatori



**KI-652.45**  
27.5 cm / 10¾"



**KI-653.47**  
27.5 cm / 10¾"



**KI-654.49**  
27.5 cm / 10¾"



**KI-655.51**  
27.5 cm / 10¾"

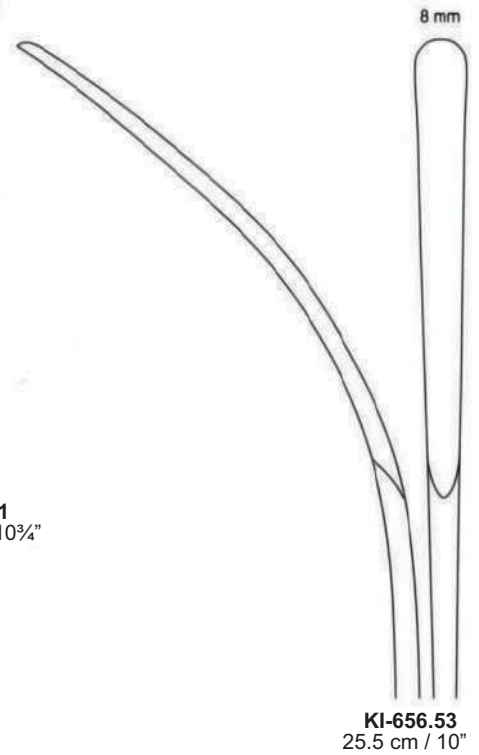

**KI-656.53**  
25.5 cm / 10"



**KI-657.54**  
28 cm / 11"

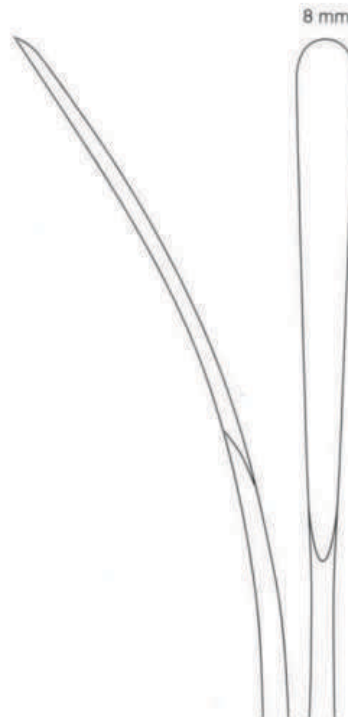

**KI-658.55**  
28 cm / 11"

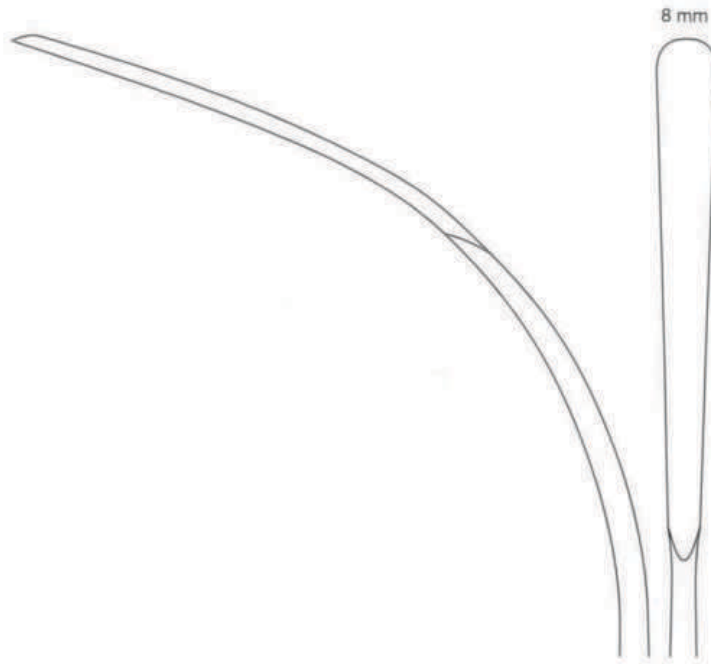

**KI-659.57**  
24 cm / 9½"



Tubing connection  
Empalme de tubo  
Embout de tuyaux  
Attacco di tubo

**KI-660.59**  
27.5 cm / 10¾"



Bone mill with assembling wrench  
 Trituradora de hueso con llave de montaje  
 Moulin à os avec clé de montage  
 Trita ossa con chiave per montaggio



65 x 30 x 30 mm

**COTTLE**  
**KI-800.70**



**KI-801.75**  
 Ø 68 x 110 mm

Enables crushing of compact bone pieces  
 Permite moler fragmentos óseos  
 Pour broyage des fragments d'os  
 Rende possibile triturare frammenti ossei

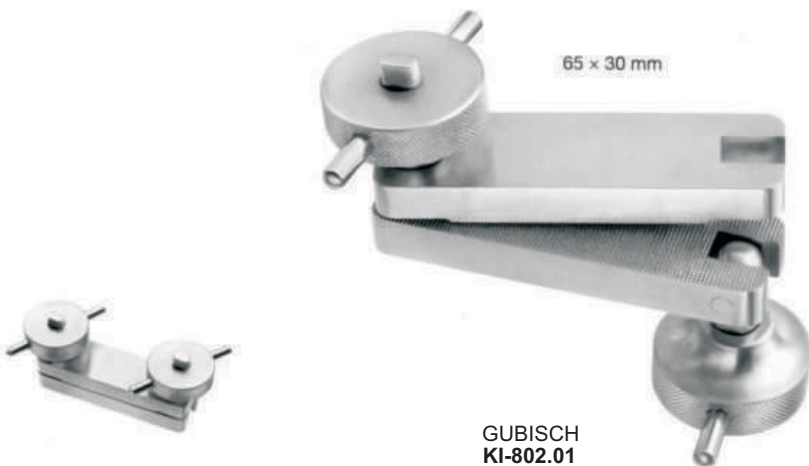

65 x 30 mm

**GUBISCH**  
**KI-802.01**



85 x 55 x 10 mm

**KI-803.75**

# LIP & CLEFT PALATE INSTRUMENTS



"Supporting Healthcare"  
**KAAHA INDUSTRIES**  
Manufacturer Of Dental & Surgical Instruments



WANG  
18 cm / 7 1/8"

KI-700.18  
left



KI-701.19  
right



WANG  
18 cm / 7 1/8"

KI-702.28  
left



KI-703.29  
right



LANGENBECK  
20 cm / 8"

KI-704.08



KI-705.10



**Elevators**  
Elevadores  
Elévateurs  
Elevatori

# LIP & CLEFT PALATE INSTRUMENTS



"Supporting Healthcare"  
**KAAHA INDUSTRIES**  
Manufacturer Of Dental & Surgical Instruments



**BLOCKSMA**  
18 cm / 7 1/8"



14 cm / 5 1/2"

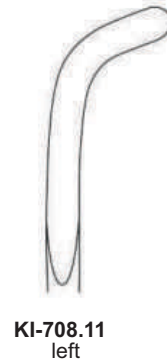

**KAHRE**  
**KI-710.20**  
17 cm / 6 3/4"



**MCINDOE**  
**KI-711.25**  
16.5 cm / 6 1/2"

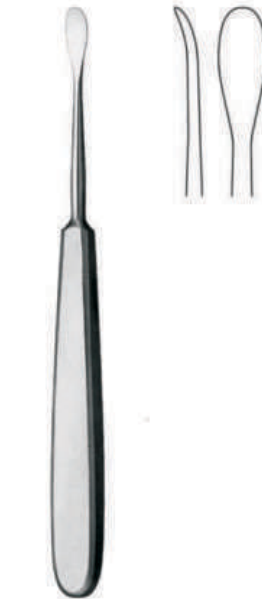

**WANG**  
**KI-712.80**  
15.5 cm / 6 1/8"

# LIP & CLEFT PALATE INSTRUMENTS



"Supporting Healthcare"  
**KAAHA INDUSTRIES**  
 Manufacturer Of Dental & Surgical Instruments

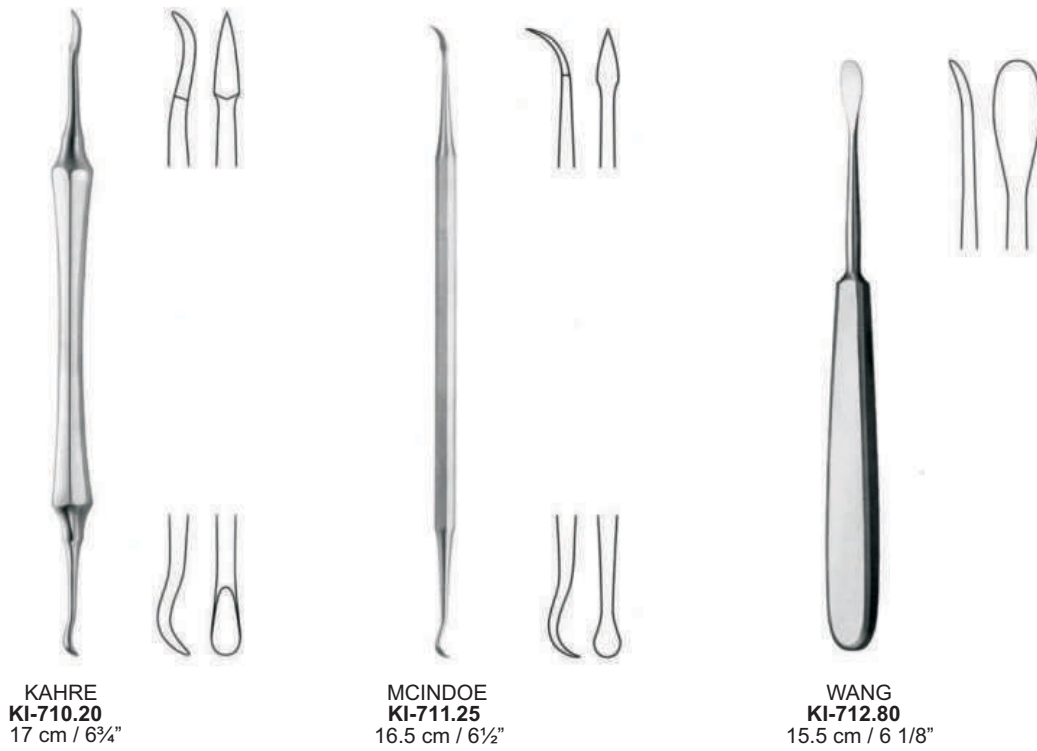
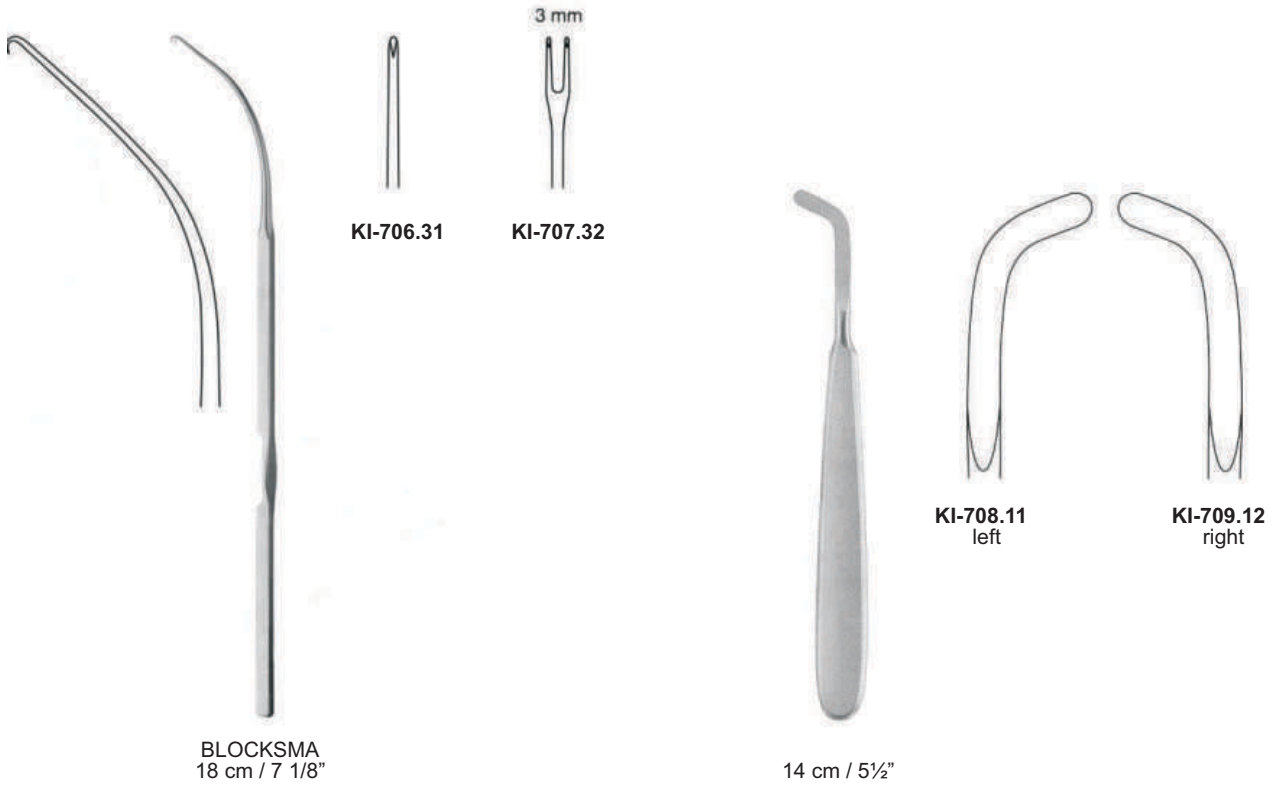

# LIP & CHEEK RETRACTORS



"Supporting Healthcare"  
**KAAHA INDUSTRIES**  
Manufacturer Of Dental & Surgical Instruments

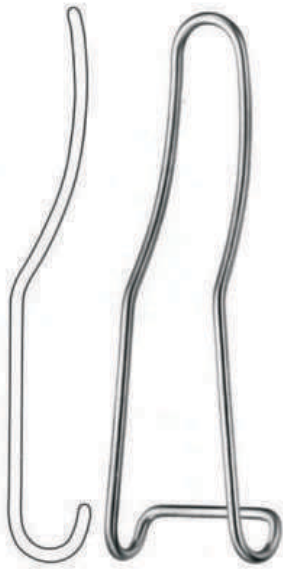

**STERNBERG**  
**KI-900.15**  
14.5 cm / 5¾"



**UNIV. MINNESOTA**  
**KI-901.34**  
15.5 cm / 6 1/8"

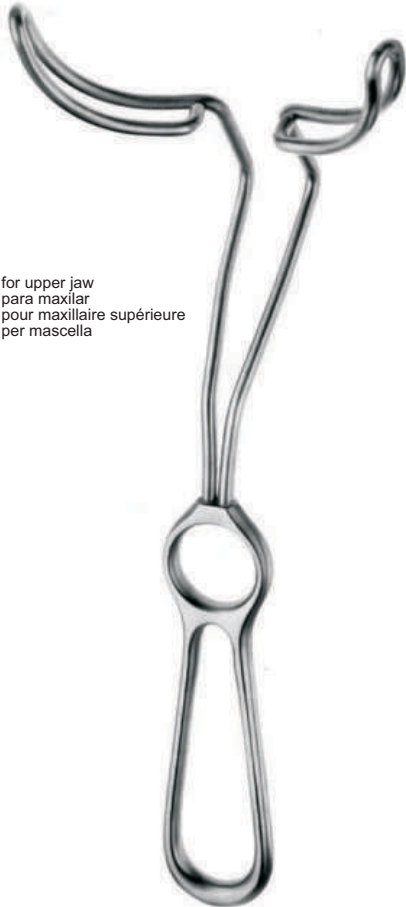

for upper jaw  
para maxilar  
pour maxillaire supérieure  
per mascella

**KI-902.21**  
21 cm / 8¼"



for lower jaw  
para mandibula  
pour maxillaire intérieure  
per mandibola

**KI-903.26**  
26 cm / 10¼"



Univer  
univer:  
univer:  
univer:

**KI-904.27**  
15 cm / 6"



MOLT

**KI-400.10**  
 10 cm / 4"  
 for children

**KI-401.15**  
 15 cm / 6"  
 for adults



ROSER KONIG  
**KI-402.45**  
 16 cm / 6 1/4"



DENHART  
**KI-403.60**  
 13 cm / 5 1/8"

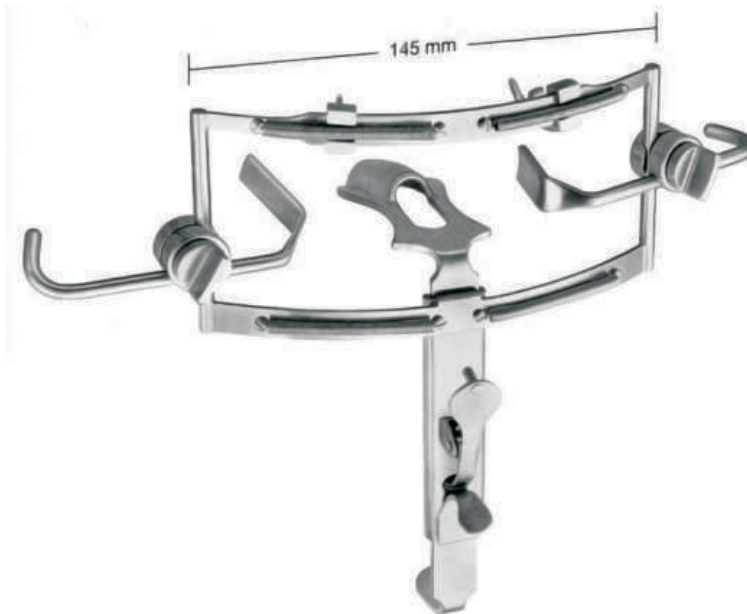

DINGMAN  
**KI-404.00**



**KI-405.11**  
 55 x 25 mm  
 Fig.1

Tongue depressor  
 Bajalengua  
 Abaisse-langue  
 Abbassalingua

**KI-406.12**  
 60 x 27 mm  
 Fig.2

**KI-407.13**  
 70 x 30 mm  
 Fig.3

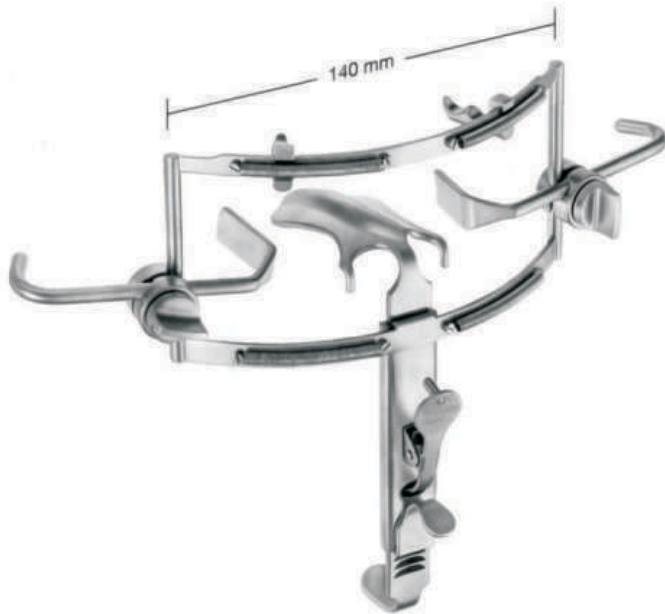

WANG  
KI-408.00



Tongue depressor  
Bajalengua  
Abaisse-langue  
Abbassalingua

**KI-409.05**  
55 x 32 mm  
Fig.1

**KI-410.06**  
60 x 35 mm  
Fig.2

**KI-411.07**  
75 x 38 mm  
Fig.3

## Style A



	L	W	D
<b>KI-500-46</b>	165 x	90 x	35 mm
<b>KI-500-50</b>	200 x	100 x	35 mm
<b>KI-500-51</b>	200 x	100 x	50 mm
<b>KI-500-53</b>	230 x	130 x	50 mm
<b>KI-500-56</b>	260 x	150 x	50 mm
<b>KI-500-58</b>	280 x	140 x	60 mm
<b>KI-500-60</b>	300 x	200 x	50 mm

## Style B



	L	W	D
<b>KI-501-46</b>	165 x	90 x	35 mm
<b>KI-501-48</b>	180 x	80 x	50 mm
<b>KI-501-50</b>	200 x	100 x	35 mm
<b>KI-501-51</b>	200 x	100 x	50 mm
<b>KI-501-53</b>	230 x	130 x	50 mm
<b>KI-501-55</b>	250 x	120 x	60 mm
<b>KI-501-56</b>	260 x	180 x	50 mm
<b>KI-501-58</b>	280 x	140 x	60 mm
<b>KI-501-60</b>	300 x	200 x	50 mm
<b>KI-501-62</b>	320 x	150 x	60 mm
<b>KI-501-66</b>	360 x	160 x	70 mm

L = Length

W = Width

D = Depth



## Style A



	L	W	D
<b>KI-500-46</b>	165 x	90 x	35 mm
<b>KI-500-50</b>	200 x	100 x	35 mm
<b>KI-500-51</b>	200 x	100 x	50 mm
<b>KI-500-53</b>	230 x	130 x	50 mm
<b>KI-500-56</b>	260 x	150 x	50 mm
<b>KI-500-58</b>	280 x	140 x	60 mm
<b>KI-500-60</b>	300 x	200 x	50 mm

## Style B



	L	W	D
<b>KI-501-46</b>	165 x	90 x	35 mm
<b>KI-501-48</b>	180 x	80 x	50 mm
<b>KI-501-50</b>	200 x	100 x	35 mm
<b>KI-501-51</b>	200 x	100 x	50 mm
<b>KI-501-53</b>	230 x	130 x	50 mm
<b>KI-501-55</b>	250 x	120 x	60 mm
<b>KI-501-56</b>	260 x	180 x	50 mm
<b>KI-501-58</b>	280 x	140 x	60 mm
<b>KI-501-60</b>	300 x	200 x	50 mm
<b>KI-501-62</b>	320 x	150 x	60 mm
<b>KI-501-66</b>	360 x	160 x	70 mm

L = Length

W = Width

D = Depth

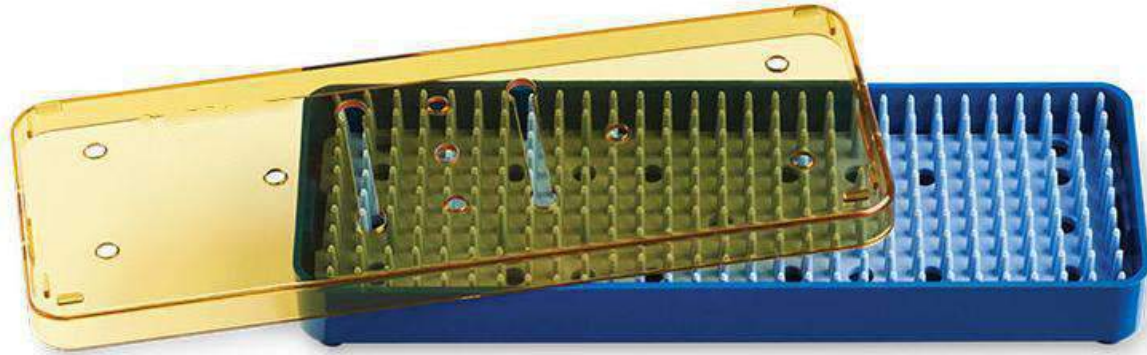

**Sterilization Tray Fiber Material, With Silicon Mat**

Item Code	Description
<b>KI-900.00</b>	Size in inch: 7" x 2.5" x 0.75"

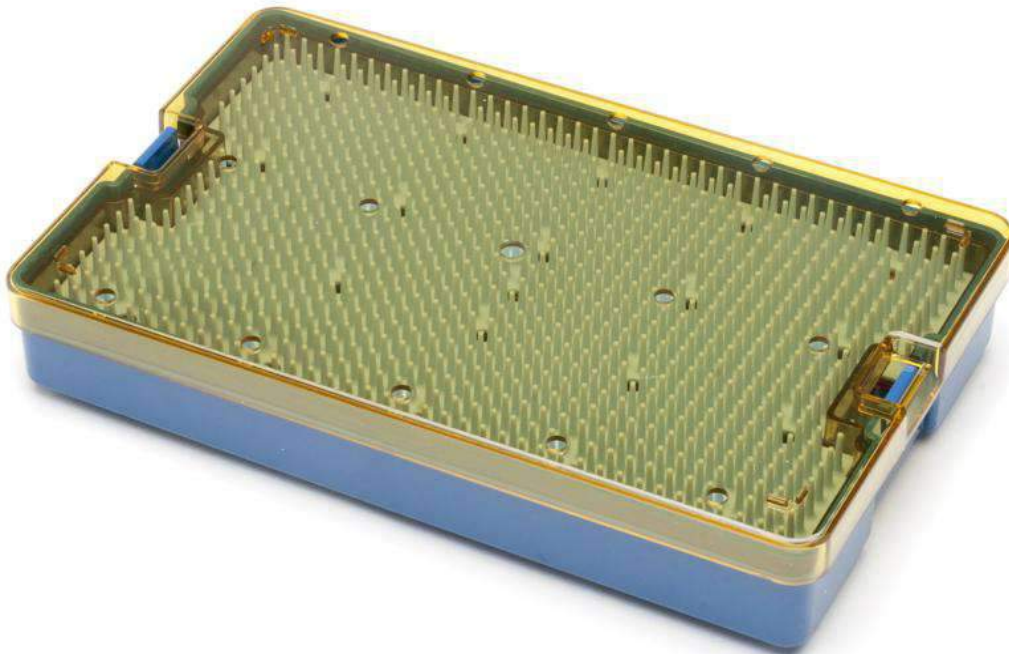

**Sterilization Tray Fiber Material, With Silicon Mat**

Item Code	Description
<b>KI-901.01</b>	Size in inch: 10" x 6" x 0.75"
<b>KI-902.02</b>	Size in inch: 10" x 6" x 1.5" With Double Silicon Mat

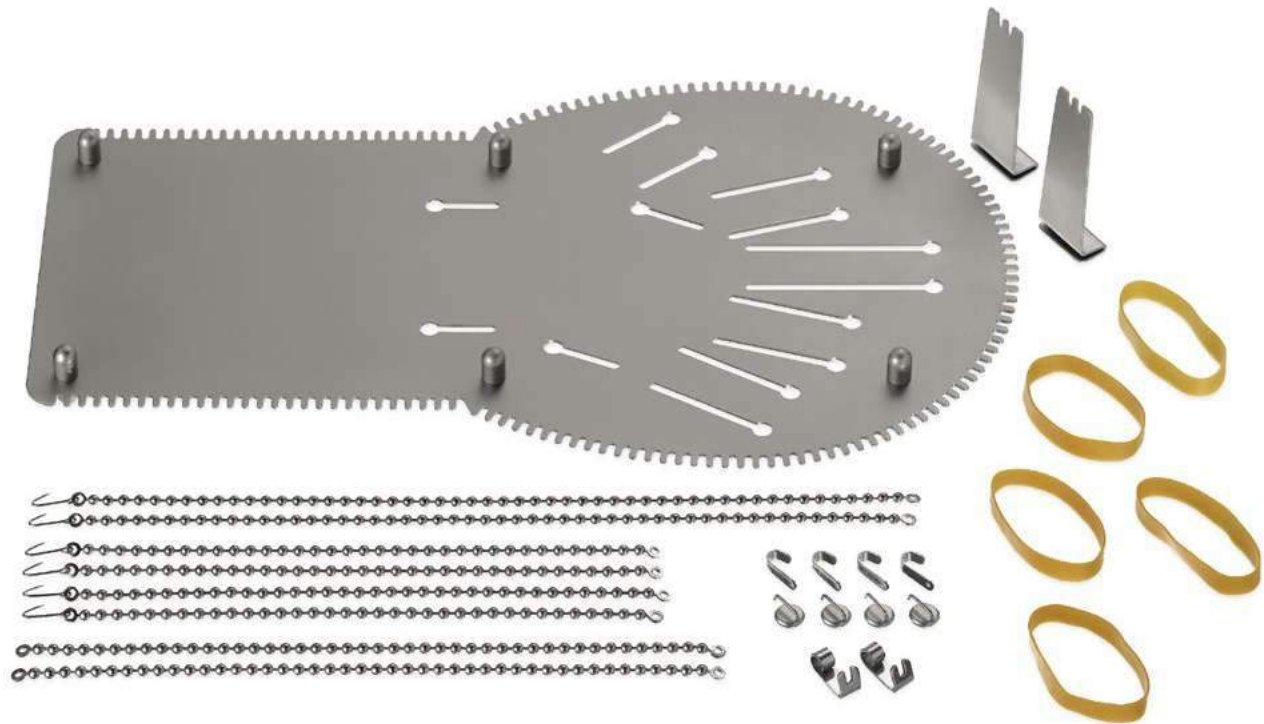

Tupper's Universal Hand Holder and Retractor Set enables the surgeon to fixate the hand in any position needed.

The patient's hand is held absolutely firm and allows unhindered work under the microscope.

Ball chains of varying length with skin or tendon hooks fixate the hand and lower arm on the Hand Holder.

Due to the slots around the Hand Holder, retraction in every direction is possible.

Upward retraction is easily achieved with the elevated chain holders.

The special container is designed for easy handling and safe storage.

## ***Tupper's Hand Retractor Set***

**KI-1000.00**

## KI-101.00



KI-101.00

## **Abdominoplasty Instruments Set Consisting of;**

Scalpel blades #15

Scalpel blades #21

Scalpel handle, #7

Scalpel handle, #4l long

Ragnell kilner scissors, 13cm, curved – flattened at distal end

Adson delicate tissue and suture forceps, 15cm, 1×2 teeth

Adson brown delicate tissue forceps, 12cm, 9×9 teeth, straight – atraumatic

Potts smith tissue forceps, 20cm, 1×2 teeth – delicate

Allis Tissue Forcep 5X6 teeth, 16cm

Wright derf t.c. needle holder, 12.5cm, serrated

Mayo hegar t.c. needle holder, 15cm

Mayo hegar t.c. needle holder, 23cm

Backhaus towel clamp, 8.5cm

Joseph skin hook, double prong, sharp, 16cm, 10mm wide

Stevens Supercut Tenotomy Scissors, 10.5cm, Curved, Blunt – Delicate

Supercut mayo scissors, 14cm, straight

Supercut gorney scissors, 23cm, curved

Supercut gorney freeman scissors, 23cm, curved "gold tip"

Supercut scissors, 20cm, curved, slight bevel on shank, "gold tip"

Supercut scissors, 20cm, curved, strong bevel on shank

Farabeuf baby retractors, 12cm, double ended, set of 2

Israel retractor, 25cm, 6 blunt prongs, 60mm wide x 50mm deep

Saldanha solz abdominal retractor, 37cm

# Abdominoplasty Set (Tummy Tuck)



"Supporting Healthcare"  
**KAAHA INDUSTRIES**  
Manufacturer Of Dental & Surgical Instruments

KI-102.00



*KI-102.00*

## **Abdominoplasty Set (Tummy Tuck), Consisting of;**

Ruler Stainless

Knife Handle No #3

Halsted Mosquito Forceps Curved 12.5cm (4PC)

Mayo-Hegar Tc Needle Holder 16cm (2PC)

Webster Tc Needle Holder Plain Tip 12.5cm

Adson Tissue Forceps 1×2 teeth With Cross Serrated 12cm (2PC)

Joseph Hook Sharp Double Prong 10mm (2PC)

Mayo Scissors Straight 14cm Tc

Gorney Freeman Scissors TC Curved 23cm

Metzenbaum Scissors SuperCut Curved 15cm

Stevens Tenotomy Scissors Supercut Curved 11.5cm

Lahey Forceps 3×3 teeth 16cm (3PC)

Allis Tissue Forceps 5×6 teeth 16cm (2PC)

Adson Brown 9×9 Teeth 12cm

Us Army Retractor 2/set

Tissue Forceps 1×2 teeth 15cm

Iris Scissors Tc 10cm

Yancoskie Retractor 6 prongs

Freeman Retractor 4 prongs 22mm

Freeman Retractor 4 prongs 38mm

Meyerding Retractor Large 50mm x 90mm 23cm (2PC)

Lockwood Abdominal Demarcator 32cm

# BLEPHAROPLASTY SET A



"Supporting Healthcare"  
**KAAHA INDUSTRIES**  
Manufacturer Of Dental & Surgical Instruments

KI-103.00





KI-103.00

## **BLEPHAROPLASTY SET A, Consisting of;**

Gillies Delicate Retractor 19cm (2PC)  
Joseph Skin Hook 16cm 2mm Double Prong Sharp (2PC)  
Desmarres Lid retractor 9x12mm 13 cm  
Scalpel handle No #3 12.5cm  
Jaeger Lid Plate Stainless Steel  
Mayo Scissors Straight T.C 14.5cm  
Steven Delicate scissors curved sharp 11.5cm  
Neivert Needle holders smooth 12.5cm  
Halsted Mosquito Hemostatic forceps curved 12.5cm (4PC)  
Backhaus Towel clamp 8.5cm (2PC)  
Micro Adson Delicate forceps Tissue 1×2 teeth 12cm  
Micro Adson Delicate forceps Tissue 1×2 teeth 15cm  
Castroviejo Calipers Measuring Range 20mm 7cm  
Castroviejo Needle Holder 14cm  
Castroviejo Scissors 14cm  
Putterman Eyelid Clamp  
Gladstone Transmarginal Clamp  
Berke Ptosis Froscep 12 cm

KI-104.00



KI-104.00

## **BLEPHAROPLASTY SET B, Consisting of;**

Scalpel Handle #3 Standard  
Stevens Scissors 11.5cm Curved Sharp  
Stevens Scissors 11.5cm Curved Blunt  
Neivert Needle Holder 12.5cm  
Halsted Mosquito Forceps 12.5cm Curved  
Backhaus Towel Clamp 8.5cm  
Gillies Dura And Skin Retractor Hook 19cm Small  
Joseph Delicate Retractor 17cm 2 Prong 5mm Sharp  
Joseph Delicate Tracheal Retractor 16cm 2 Prong 8mm Blunt  
Supercut Mayo Scissors 14cm Straight  
Desmarres Lid Retractor #1 14cm Small 9x12mm  
Castroviejo Measuring guage 7 cm Measuring Guage 20mm  
Bishop Harmon Iris Forceps 1X2 teeth 0.3mm  
Castroviejo Suturing Forceps 1X2 teeth 0.9mm

# BREAST AUGMENTATION SET



"Supporting Healthcare"  
**KAAHA INDUSTRIES**  
Manufacturer Of Dental & Surgical Instruments

KI-105.00



## KI-105.00

### **BREAST AUGMENTATION SET, Consisting of;**

Scalpel Handle No. #3  
Halsted Mosquito Forceps Curved 12.5cm (4PC)  
Metzenbaum Scissors Supercut 18cm Curved (2PC)  
Gorney Freeman Scissors Supercut curved 23cm  
Mayo Scissors 18cm straight (2PC)  
Iris Scissors TC straight 11.5cm (2PC)  
Yankauer Suction Tube 28cm  
Frazier Suction Tube 12 FR (2PC)  
Adson Dressing Forceps 12cm (2PC)  
Adson Tissue & Suture Forceps 1×2 teeth with tying platform (2PC)  
Brown-Adson Forceps 9×9 teeth 12cm (2PC)  
Tissue Forceps 1×2 teeth 15cm  
Dressing Forceps serrated 15cm  
Freeman Areola Marker 38mm  
Freeman Areola Marker 42mm  
Freeman Areola Marker 45mm  
Freeman Areola Marker 50mm  
McKissock Breast Marker 38mm Keyhole pattern  
McKissock Breast Marker 42mm Keyhole pattern  
McKissock Breast Marker 45mm Keyhole pattern  
Mayo-Hegar Needle Holder TC 16cm  
Webster Needle Holder TC smooth jaws 13cm  
Halsey Needle Holder TC smooth jaws 14cm  
McKissock Mammoplasty Caliper  
Stainless Steel Ruler 15cm  
Tebbetts Spatulated Breast Dissector 33cm  
Silverstein Breast Dissector  
Joseph Hook sharp 5mm 16cm (2PC)  
Senn Muller Retractor Insulated sharp  
US Army Retractor set of 2 Insulated  
Freeman Retractor 4 prong 38mm (2PC)  
Pediatric Ribbon Retractor malleable  
Ferreira Fiber Optic Retractor 150x25mm Insulated  
Deaver Fiber Optic Retractor  
Tebbetts Fiber Optic Retractor 150x25mm Insulated

# CHIN AUGMENTATION SET



"Supporting Healthcare"  
**KAAHA INDUSTRIES**  
Manufacturer Of Dental & Surgical Instruments

KI-106.00



**KI-106.00**

**CHIN AUGMENTATION SET , Consisting of;**

Scalpel Handle, #3 Standard

Iris Scissors, 9cm, Curved – Delicate

Baby Metzenbaum T.C. Scissors, 11.5cm, Curved

Metzenbaum T.C. Scissors, 14cm, Curved

Collier Needle Holder, 13cm

Neivert T.C. Needle Holder, 12.5cm, Smooth

Halsted Mosquito Forceps, 12.5cm, Curved

Joseph Skin Hook, Double Prong, Sharp, 16cm, 7mm Wide

Walter Bone Elevator, 14.5cm, 8mm, Curved

Walter Raspatory, 14.5cm, 8mm, Curved

Walter Alar And Nasal Retractor With Fiber Optic Illumination, 18.5cm

Aufricht Walter Nasal Retractor, 13.5cm, Double Ended, Sharp, 42x7mm

Aufricht Walter Nasal Retractor, 13.5cm, Double Ended, Blunt, 38x7mm

## KI-107.00

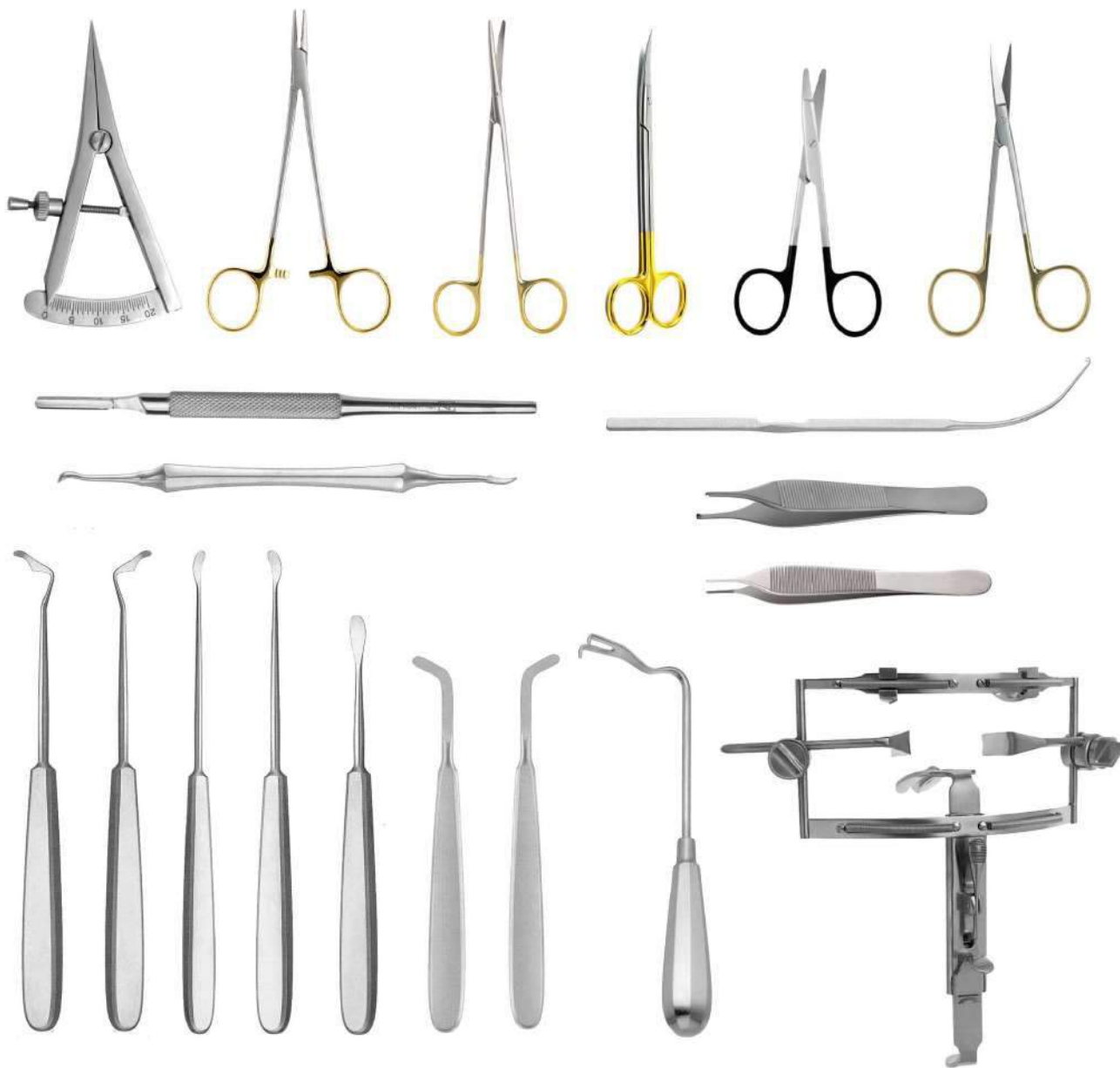





KI-107.00

## **CLEFT & PALATE INSTRUMENTS SET, Consisting of;**

Scalpel Round Handle 16cm  
Adson Forceps 15cm Serrated  
Adson Forceps 15cm 1×2 Teeth  
Iris Supercut Scissors 11.5cm Straight  
Iris Supercut Scissors 11.5cm Curved  
Ragnell Kilner Scissors 13cm Curved  
Supercut Plus Kelly T.C. Scissors 16cm Curved  
Metzenbaum T.C. Scissors 18cm Curved  
Crile Wood T.C. Needle Holder 15cm  
Blocksma Cleft Palate Hook 18cm 3mm 2 Prong  
Cleft Palate Raspatory 14cm #1 Left  
Cleft Palate Raspatory 14cm #2 Right  
Kahre Cleft Palate Raspatory 17cm  
Mcindoe Cleft Palate Raspatory 16.5cm  
Muco-Periosteal Retractor 19cm  
Wang Cleft Palate Elevator 15.5cm  
Wang Cleft Palate Elevator 18cm Right  
Wang Cleft Palate Elevator 18cm Left  
Wang Cleft Palate Elevator 18cm Right Angled  
Wang Cleft Palate Elevator 18cm Left Angled  
Castroviejo Caliper 7cm 20mm Measuring Range  
Dingman Mouth Gag Complete

# FACE & FOREHEAD LIFT SET



"Supporting Healthcare"  
**KAAHA INDUSTRIES**  
Manufacturer Of Dental & Surgical Instruments

KI-108.00



**KI-108.00**

**FACE & FOREHEAD LIFT SET, Consisting of;**

Scalpel Blades #15 – Sterile, 100/Box

Scalpel Handle, #7

Micro Adson Forceps 12cm 1×2 Teeth – 0.8mm Tips

Adson Brown Delicate Tissue Forceps 12cm 7×7 Teeth Straight – Atraumatic

Select Tissue Forceps 20cm 1×2 Teeth – Extremely Fine

Nagata T.C. Needle Holder 12.5cm Extra Fine

Baby Crile Wood T.C. Needle Holder 15cm

Backhaus Towel Clamp 8.5cm

Gillies Dura And Skin Retractor Hook 19cm Small

Joseph Delicate Retractor 17cm 2 Prong 5mm Sharp

Iris Supercut Scissors 12.5cm Curved

Supercut Mayo Scissors 14cm Straight

Gold Tip Supercut Scissors 20cm Curved Slight Bevel On Shank

Gold Tip Supercut Scissors 20cm Curved Strong Bevel On Shank

Farabeuf Baby Retractors 12cm Double Ended Set Of 2

Walter Retractor 19cm 4 Prongs 38mm

Langenbeck Kocher Retractor #13 15mm Wide X 80mm Deep 21cm

Solz Racket Retractor 12.5cm 45x100mm

Pitanguy Facelift Marker 16cm 5mm Wide

## KI-109.00



## KI-109.00

### FACELIFT SET, Consisting of;

Adson Dressing Forcep TC 12cm (2PC)  
Allis Forceps 15cm 5×6 teeth (4PC)  
Facelift SuperCut Scissors 16.5cm Curved (2PC)  
Face Lift SuperCut Scissors 20.5cm Curved (2PC)  
Backhaus Towel Forceps 9cm (4PC)  
Adson Brown 7×7 Forcep Tc 12cm  
Adson Brown 7×7 Forcep TC 15cm (2PC)  
Crile Forceps Curved 16cm (3PC)  
Crow Coagation Insulated Forcep TC 23cm (3PC)  
Gillies Skin Hook 18cm (3PC)  
Halstead Mosquito Forceps Curved 12.5cm (8PC)  
Halstead Mosquito Forceps Curved 12.5cm 1×2 teeth (4PC)  
Adson Horton 12cm TC 1×2 teeth (2PC)  
Adson Horton 15cm Tc 1×2 teeth  
Knife Handle #3 (2PC)  
Knife Handle #4 (2PC)  
Light Weight Straight Skin Hook 15cm Delicate (3PC)  
Mayo SuperCut Scissors 17 cm Curved  
Metzenbaum Delicate SuperCut Scissors 18 cm Curved  
Nasal Tip Retractor 11cm 8mm  
KI Needle Holder 11.5cm TC (4PC)  
Pitanguy Flap Grasping Forceps 14cm  
Ribbon Iris Scissors 9cm Curved  
Ruler 15cm

## KI-110.00



**KI-110.00**

**Mammoplasty Set, Consisting of;**

Scalpel Blades #15 – Sterile 100/Box

Scalpel Handle #7

Jabeley Scissors 13cm Curved Sharp/Sharp

Metzenbaum Scissors 20cm Curved Standar Pattern

Micro Adson Forceps 12cm 1×2 Teeth 0.8mm Tips

Gruenwald Nasal Bayonet Forceps 19.5cm Serrated Tips

Baby Crile Wood Needle Holder 15cm

Baby Crile Wood T.C. Needle Holder 15cm

Jabeley Supercut Scissors 13cm Curved Sharp/Sharp

Solz Gold Tip TC with Supercut Scissors 20cm Curved Slight Bevel On Shank

Solz Gold Tip TC with Supercut Scissors 20cm Curved Strong Bevel On Shank

Farabeuf Baby Retractors 12cm Double Ended Set Of 2

Langenbeck Kocher Retractor #13 15mm Wide X 80mm Deep 21cm

Atraumatic Breast Dissector 34cm

Breast Hook Dissector Curved to Left 36cm

Breast Hook Dissector Curved to Right 36cm

Areola Marker Blunt 36mm Diameter

Areola Marker Blunt 40mm Diameter

Areola Marker Blunt 42mm Diameter

Areola Marker Blunt 45mm Diameter

Marx Breast Retractor 27cm 125 X 30mm

Round Bowl For Solutions/Marking Color 60x30mm 60cc



KI-111.00







KI-111.00

PLASTIC SURGERY INSTRUMENTS SET, Consisting of;

## KI-112.00

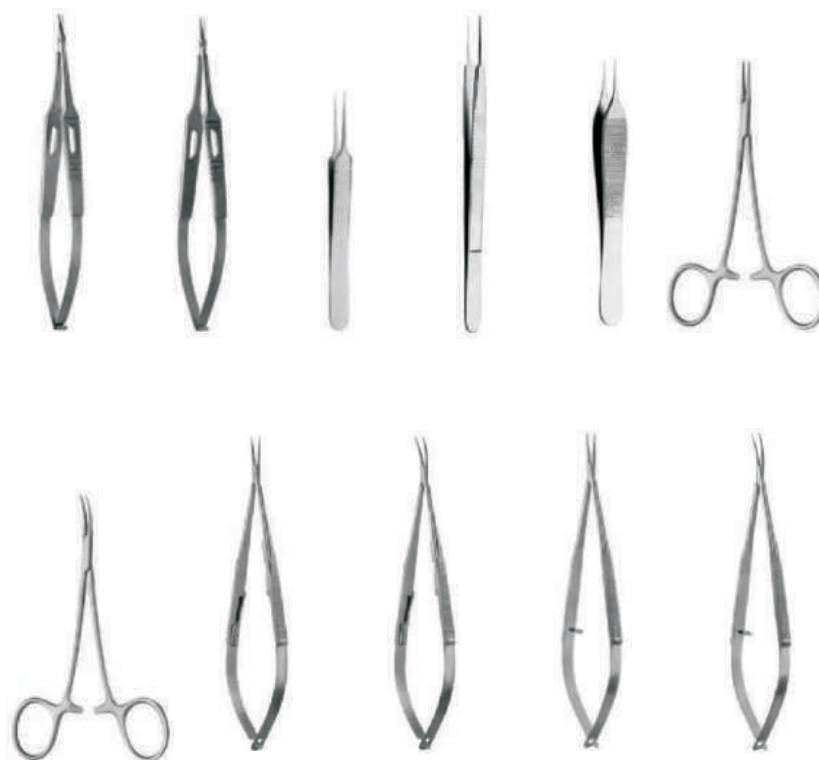

- KOSHIMA Micro instruments set -  
 complete Consisting of :
- KOSHIMA Micro scissors . curved . vannas-type cutting edges (15cm)
  - KOSHIMA Micro scissors . straight . vannas-type cutting edges (15cm)
  - KOSHIMA Micro forceps (11 cm)
  - MICRO 2000 (KOSHIMAZ) micro forceps (14cm)
  - JACOBSON ADSON (KOSHIMA) Micro needle holder, straight .  
 with catch (14.5 cm)
  - MICRO JACOBSON (KOSHIMA) Hemostatic forceps,  
 straight (12.5cm)
  - MICRO JACOBSON (KOSHIMA) Hemostatic forceps,  
 curved (12.5cm).
  - CASTROVIEJO (KOSHIMA) Micro needle holder, curved .  
 with catch (14.5 cm)
  - CASTROVIEJO (KOSHIMA) Micro needle holder, curved,  
 with catch (14.5cm)
  - CASTROVIEJO (KOSHIMA) Micro needle holder, straight, (14.5cm)
  - CASTROVIEJO (KOSHIMA) Micro needle holder, curved, (14.5cm)

KI-113.00

RhinoPlasty Instruments Set ( Walter Set ), Consisting of;

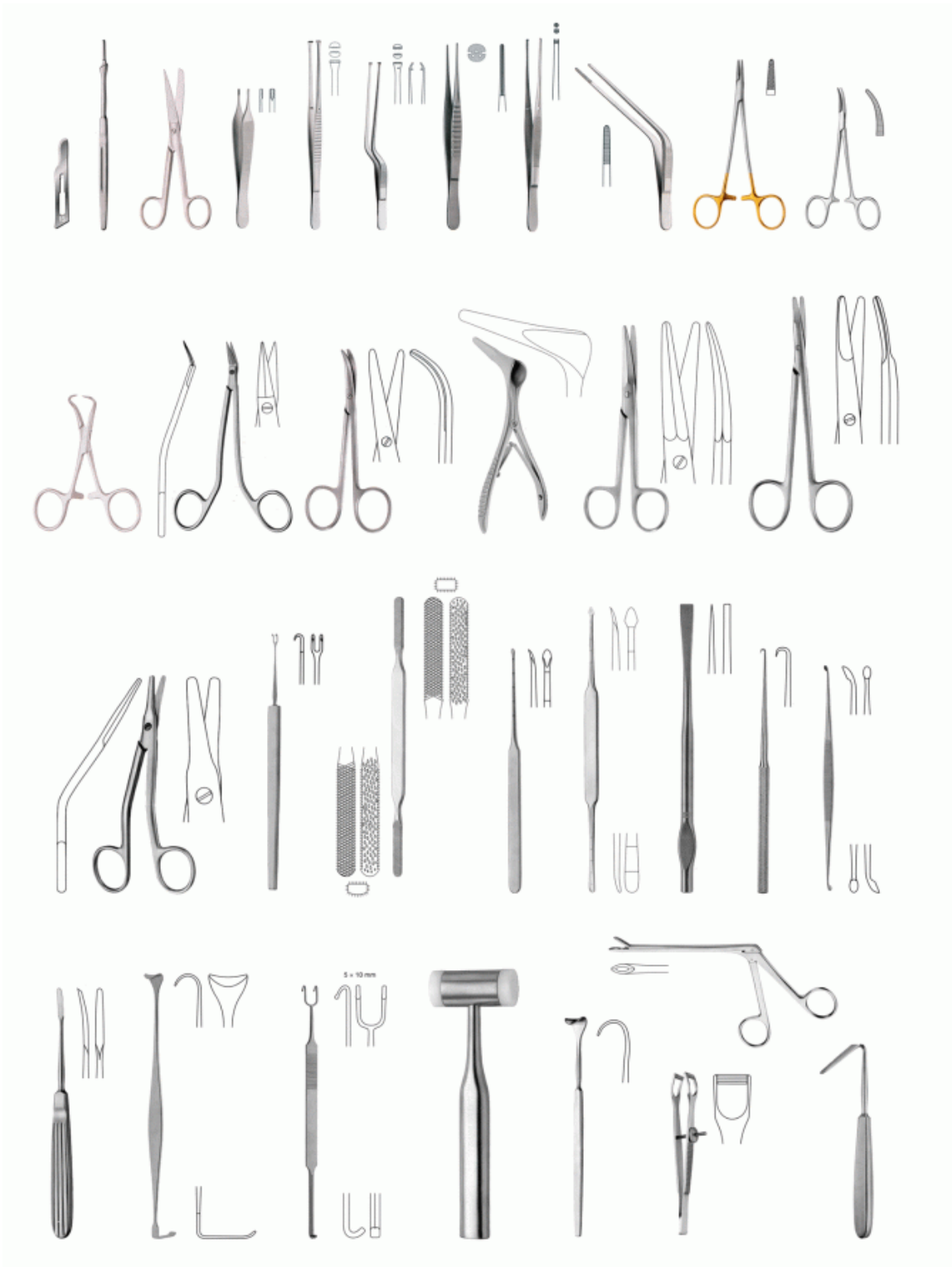

## KI-113.00

### RhinoPlasty Instruments Set ( Walter Set ), Consisting of;

Scalpel Handle, #7k,  
Surgical Operating Scissors, 14.5cm, Curved - Sharp/Blunt  
Ragnell Kilner Scissors, 15cm, Curved - Flattened At Distal End  
Fox T.C. Gum And Tissue Scissors, 13cm, Curved, 1 Serrated Blade  
Adson Brown Delicate Tissue Forceps, 12cm, 7x7 Teeth, Straight  
Adson Brown Delicate Tissue Forceps, 12cm, 9x9 Teeth, Straight  
Semken Delicate Tissue Forceps, 12.5cm, 2x3 Teeth, Straight  
Debakey At Vascular Forceps, 15cm - 1.5mm Tips  
Bayonet Grasping Forceps, 16cm  
Bayonet Grasping Forceps, 16cm, 1x1 Teeth  
Troeltsch Wilde Angular Forceps, 13cm, Adult Size - Serrated  
Grooved Director And Tongue Tie, 11.5cm  
Frazier Fergusson Suction Tube, 18cm, Angled, 10 French e  
Senning T.C. Needle Holder, 17cm, Serrated  
Halsted Micro Mosquito Forceps, 12.5cm, Curved  
Backhaus Towel Clamp, 8.5cm  
Gross Dressing Forceps, 20cm, Straight - Without Catch, Box Lock  
Walter Cope Retractor, 17.5cm  
Joseph Skin Hook, 16cm, Single Prong, Sharp  
Guthrie Double Retractor Hook, 13cm, 2mm Wide, Sharp  
Lempert Raspatory, 17cm, 4mm, Delicate, Sharp  
Supercut Walter Dorsal Scissors, 14cm, Angular  
Supercut Walter Cottle Dorsal Scissors, 16cm, Curved  
Medicon Mallet, 18.5cm, Plastic Facings, 200 Grams, 25mm Diameter  
Walter Williger Bone Curette, 13.5cm, 2/2mm, Double Ended, Sharp, Angled  
Defourmentel Bone Rongeur, 19cm, Straight, Slender Beaks - Jaws 3mm Wide  
Weil Blakesley Wilde Ethmoid Bone Forceps #3, 120mm Shaft, 4.2mm  
Weil Blakesley Wilde Ethmoid Bone Forceps #2, 45 Degree Angle, 120mm Shaft, 3.6mm  
Myles Nasal Through Cutting Forceps #4, 120mm Shaft  
Cottle Nasal Septum Speculum, 14cm, 50mm  
Cottle Elevator, 16cm, 2.5mm  
Masing Septum Elevator, 22cm, 5/5mm, Double Ended  
Aufrecht Walter Nasal Retractor, 13.5cm, Double Ended, Sharp, 42x7mm  
Aufrecht Walter Nasal Retractor, 13.5cm, Double Ended, Blunt, 38x7mm  
Walter Chisel/Osteotome, 19cm, 3mm, Modified  
Walter Chisel/Osteotome, 19cm, 5mm, Modified  
Walter Osteotome, 19cm, 2mm, Straight  
Walter Osteotome, 19cm, 12mm, Straight  
Walter Chisel/Osteotome, 19cm, 12mm, Modified  
Walter Osteotome, 19cm, 6mm, Curved  
Walter Cantanares Lifting Scissors, 16cm, Curved  
Fomon Rhinoplasty Scissors, 12.5cm  
Cottle Columella Forceps, 11cm  
Fomon Bone And Nasal Rasp, 20cm  
Asch Septum Straightening Forceps, 22cm, Angled  
Brunings Tongue Depressor, 19cm, 14mm

KI-114.00

RHINOPLASTY INSTRUMENTS SET (Gubisch Set), Consisting of;



## KI-114.00

### RHINOPLASTY INSTRUMENTS SET (Gubisch Set), Consisting of;

Scalpel Blades #15 - Sterile,  
Scalpel Handle, #7  
Surgical Operating Scissors, 13cm, Straight - Sharp/Blunt  
Mayo Stille T.C. Operating Scissors, 17cm, Curved  
Reynolds Jameson Scissors, 14cm, Curved - With Fine, Rounded Points  
Adson T.C. Tissue Forceps, 12cm  
Micro Adson Forceps, 12cm, 1x2 Teeth - 0.8mm Tips  
Adson Brown Delicate Tissue Forceps, 12cm, 7x7 Teeth, Straight - Atraumatic  
Dressing Forceps, 20cm - Modified Swedish Pattern  
Nelson Tissue Forceps, 15cm  
Gruenwald Jansen Nasal Dressing Bayonet Forceps, 16cm, Serrated  
Gubisch T.C. Needle Holder, 12.5cm, Extra Fine  
Crile Wood T.C. Needle Holder, 15cm  
Halsted Micro Mosquito Forceps, 12.5cm, Curved  
Leriche Artery Forceps, 15cm, 1x2 Teeth, Straight  
Pean Hemostatic Forceps, 14cm, Straight  
Backhaus Towel Clamp, 13cm  
Dressing Forceps, 17.5cm, Curved, Delicate  
Gross Dressing Forceps, 20cm, Curved - With Catch, Box Lock  
Barsky Skin Hook, 15cm, Single Prong, Sharp  
Joseph Delicate Retractor, 17cm, 2 Prong, 5mm, Sharp  
Guthrie Double Retractor Hook, 13cm, Sharp  
Supercut Plus T.C. Mayo Scissors, 14cm, Straight  
Supercut Plus T.C. Mayo Scissors, 17cm, Curved  
Supercut Plus Metzenbaum T.C. Scissors, 18cm, Curved  
Supercut Plus Kelly T.C. Scissors, 16cm, Curved  
Langenbeck Bone Elevator, 20cm, 7mm, Blunt  
Freer Raspatory, 19cm, 5/5mm, Double Ended, Sharp / Sharp  
Williger Raspatory, 16cm, 5mm, Sharp  
Mckenty Raspatory, 15cm, 4mm, Sharp, Light Curve  
Supercut Heymann Nasal Scissors, 18cm  
Supercut Plus Fomon T.C. Dorsal Scissors, 13cm, Angular  
Mallet, 26cm, Novotex Plastic, 240 Grams, 45mm Diameter  
Round Bowl For Solutions, 40x20mm, 20cc  
Round Bowl For Solutions/Marking Color, 60x30mm, 60cc  
Round Bowl For Solutions, 80x40mm, 160cc  
Round Bowl For Solutions, 110x55mm, 400cc  
Castroviejo Caliper, 7cm, 20mm Measuring Range  
Desmarres Lid Retractor #2, 14cm, Medium, 10x14mm  
Killian Asept Nasal Speculum, #4, 90mm (Modified)  
Weil Blakesley Wilde Ethmoid Bone Forceps #3, 120mm Shaft, 4.2mm  
Freer Septum Knife (Mucosa Scalpel), 16cm  
Cottle Nasal Speculum, Delicate, 15cm, 55mm  
Gubisch Suction Raspatory With Guide And Bypass Hole, 20cm, 4mm  
Gubisch Suction Raspatory With Guide, 17cm, 4mm  
Cartilage Cutting Block, Teflon, 85x55x10mm  
Gubisch Cartilage Crusher, 65x30mm  
Gubisch Kilner Double Nasal Hook (Alar Retractor), 8cm, Sharp, 5x10mm  
Gubisch Aufricht Nasal Retractor, 17cm, 50x6-12mm  
Cottle Gubisch Chisel, 18cm, 5mm, Graduated, Hollow Cut  
Cottle Gubisch Chisel, 18cm, 12mm, Graduated, Hollow Cut  
Gubisch Osteotome, 18.5cm, 3mm, Aluminium Handle  
Fanous Osteotome, 19.5cm, 4mm, Straight, With Guide Thorn - 1)  
Caplan Nasal Septum Scissors, 20cm, Serrated  
Gubisch Fomon T.C. Nasal Rasp, 20cm  
Rubin T.C. Septal Morselizer Forceps, 20cm, With Protective Guard  
Buchwald Tongue Spatula, 18cm, 18x23mm



“Supporting Healthcare”

**KAAHA INDUSTRIES**

Manufacturer Of Dental & Surgical Instruments

☎ +92-300-717-1438

☎ +92-52-353-1555

☎ +92-52-353-1555

✉ sales@kaahaindustries.com

✉ info@kaahaindustries.com

🌐 www.kaahaindustries.com

📍 Head Marala Road, Kotli Loharan East, P.O.Box 51220 - Sialkot - Pakistan.

