

*Friendly Specialist*  
**SERVICE**

# *General Surgery Instruments Catalogue*



*“Supporting Healthcare”*

**KAAHA INDUSTRIES**

Manufacturer Of Dental & Surgical Instruments

# CONTENT PAGE



"Supporting Healthcare"  
**KAAHA INDUSTRIES**  
Manufacturer Of Dental & Surgical Instruments

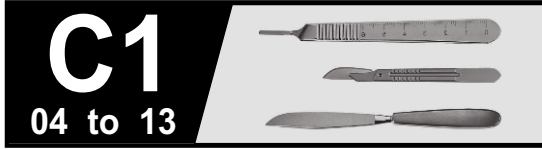

Skalpellklingen, Skalpellgriffe, Messer  
Scalpel Blades, Scalpel Handles, Knives  
Hojas de bisturías, Mangos de bisturías, Cuchillos  
Lame per bisturi, Manici per bisturi, Coltelli

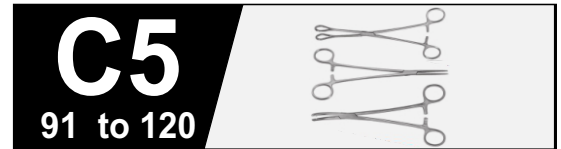

Klemmen  
Forceps  
Pinas  
Pinze

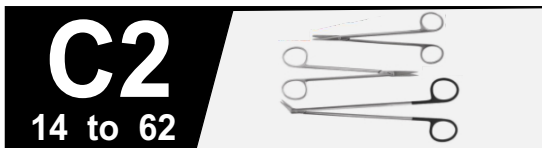

Scheren  
Scissors  
Tijeras  
Forbici



Nahtinstrumente  
Suture Instruments  
Instrumentos para sutura  
strumenti per sutura



Pinzetten  
Forceps  
Pinzas  
Pinze



Wundhaken  
Retractors  
Separadores  
Divaricatori



Tuch-, Schlauchklemmen, Tupferzangen  
Towel Clamps, Sponge and Dressing Forceps, Tubing Clamps  
Pinzas de campo, Pinzas para vendajes y torundas y para tubos  
Pinze per fissare le compresse, per medicatura e tamponi, e per tubi



Wundspreizer  
Self-Retaining Retractors  
Separadores con retenida automática  
Divaricatori autostatici

# CONTENT PAGE



"Supporting Healthcare"  
**KAAHA INDUSTRIES**  
Manufacturer Of Dental & Surgical Instruments



Sonden, Trokare

Probes, Trocars

Sondas, Trócares

Sonde, TrequaAKi

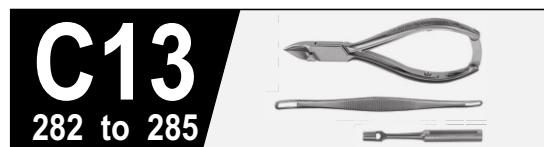

Vorbereitung, Dermatologie

Preparation, Dermatology

Preparación, Dermatología

Preparazione, Dermatalogia



Galle, Leber, Niere, Blase, Urologie

Gall, Liver, Kidney, Bladder, Urology

Bilis, Hígado, Riñon, Vejiga, Urología

Bile, Fegato, Rene, Vescica, Urologia



Knochenchirurgie

Bone Surgery

Cirurgía ósea

Chirurgia ossea



Magen, Darm, MaAKdarm

AKomach, InteAKines, ReAKum

EAKómago, InteAKino, ReAKo

AKomaco, InteAKino, Retto



AKerilisation

AKerilization

EAKerilización

AKerilizzazione



Gynäkologie, GebuAAKhilfe

Gynecology, ObAKetrics

Ginecología, ObAKetricia

Ginecologia, OAKetricia



“Supporting Healthcare”

**KAAHA INDUSTRIES**

Manufacturer Of Dental & Surgical Instruments

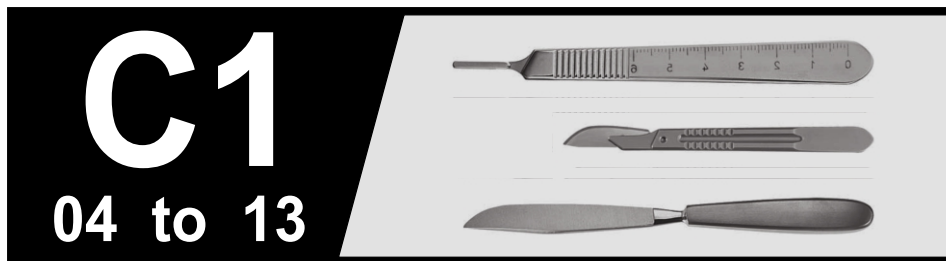

**Skalpellklingen, Skalpellgriffe, Messer**

**Scalpel Blades, Scalpel Handles, Knives**

**Hojas de bisturías, Mangos de bisturías, Cuchillos**

**Lame per bisturi, Manici per bisturi, Coltelli**

# General Surgery Instruments



"Supporting Healthcare"  
**KAAHA INDUSTRIES**  
Manufacturer Of Dental & Surgical Instruments

Sterile Skalpellklingen, Skalpellgriffe  
Sterile Scalpel Blades, Scalpel Handles  
Hojas de bisturíes estériles, Mangos de bisturíes  
Lame per bisturi sterili, Manici per bisturi



No. 3  
13,0 cm, 5"  
KI-1001-01



No. 3  
13,0 cm, 5"  
KI-1001-02



No. 3L  
21,0 cm, 8¼"  
KI-1001-03



No. 7  
16,5 cm, 6½"  
KI-1001-04



No. 7K  
13,0 cm, 5"  
KI-1001-05

# General Surgery Instruments



"Supporting Healthcare"  
**KAAHA INDUSTRIES**  
Manufacturer Of Dental & Surgical Instruments

Sterile Skalpellklingen, Skalpellgriffe  
Sterile Scalpel Blades, Scalpel Handles  
Hojas de bisturios estériles, Mangos de bisturios  
Lame per bisturi sterili, Manici per bisturi



No. 4  
13,5 cm, 5<sup>3</sup>/<sub>8</sub>"  
KI-1001-06



No. 4L  
21,0 cm, 8<sup>3</sup>/<sub>8</sub>"  
KI-1001-07



No. 8  
13,5 cm, 5<sup>3</sup>/<sub>8</sub>"  
KI-1001-08



No. 9  
14,5 cm, 5<sup>3</sup>/<sub>4</sub>"  
KI-1001-09

# General Surgery Instruments



"Supporting Healthcare"  
**KAAHA INDUSTRIES**  
Manufacturer Of Dental & Surgical Instruments

Einmal-Skalpelle, steril  
Disposable Scalpels, sterile  
Bisturíes para uso único, estériles  
Bisturi monouso, sterili



Fig. 10  
KI-1001-10



Fig. 11  
KI-1001-11



Fig. 11s  
KI-1001-12



Fig. 12  
KI-1001-13



Fig. 12d  
KI-1001-14



Fig. 13  
KI-1001-15



Fig. 15  
KI-1001-16



Fig. 15c  
KI-1001-17

Einmal-Skalpelle, steril  
Disposable Scalpels, sterile  
Bisturías para uso único, estériles  
Bisturi monouso, sterili



Fig. 18  
KI-1001-18



Fig. 19  
KI-1001-19



Fig. 20  
KI-1001-20



Fig. 21  
KI-1001-21



Fig. 22  
KI-1001-22



Fig. 23  
KI-1001-23



Fig. 24  
KI-1001-24



Fig. 25  
KI-1001-25



# General Surgery Instruments



"Supporting Healthcare"  
**KAHA INDUSTRIES**  
 Manufacturer Of Dental & Surgical Instruments

Skalpelle  
 Knives  
 Bisturies  
 Bisturi



Fig. 1 **KI-1001-25**  
 Fig. 2 **KI-1001-26**  
 Fig. 3 **KI-1001-01**



**OPERATION**  
 17,0 cm, 6¾"



Fig. 10 **KI-1001-31**  
 Fig. 12 **KI-1001-32**  
 Fig. 14 **KI-1001-33**  
 Fig. 16 **KI-1001-34**  
 Fig. 18 **KI-1001-35**



**COLLIN**  
 16,0 cm, 6¼"



Fig. 4 **KI-1001-28**  
 Fig. 5 **KI-1001-29**  
 Fig. 6 **KI-1001-30**

Skalpelle  
 Knives  
 Bisturies  
 Bisturi



Fig. 1 **KI-1001-36**  
 Fig. 2 **KI-1001-37**  
 Fig. 3 **KI-1001-38**  
 Fig. 4 **KI-1001-39**  
 Fig. 5 **KI-1001-40**



Fig. 1 **KI-1001-41**  
 Fig. 2 **KI-1001-42**  
 Fig. 3 **KI-1001-43**  
 Fig. 4 **KI-1001-44**  
 Fig. 5 **KI-1001-45**



Fig. 15 **KI-1001-46**



**DISSECTING**  
 17,0 cm, 6¾"



Fig. 6 **KI-1001-47**  
 Fig. 7 **KI-1001-48**  
 Fig. 8 **KI-1001-49**  
 Fig. 9 **KI-1001-50**  
 Fig. 10 **KI-1001-51**



**DIEFENBACH**  
 16,0 cm, 6¼"

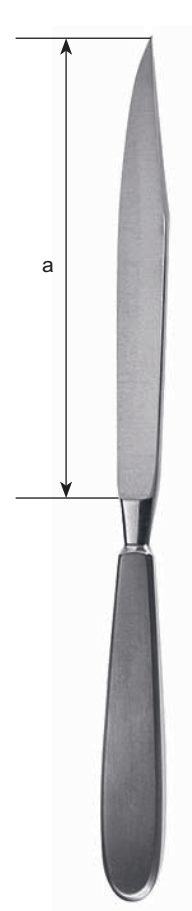
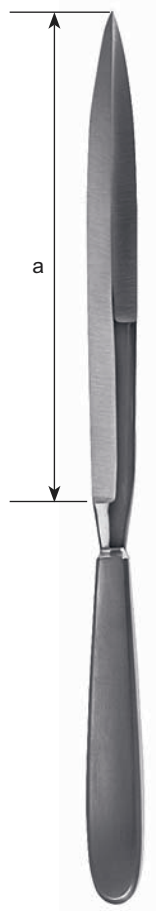
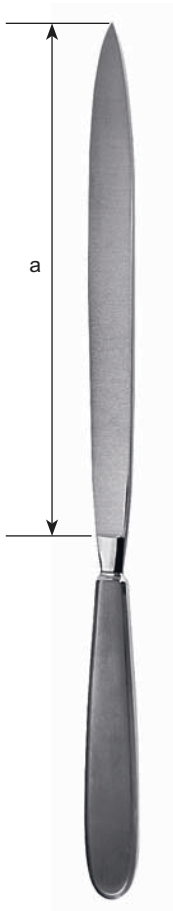

Fig. 6 **KI-1001-52**  
 Fig. 7 **KI-1001-53**  
 Fig. 8 **KI-1001-54**  
 Fig. 9 **KI-1001-55**



Fig. 16 **KI-1001-56**

Amputationsmesser  
 Amputation Knives  
 Cuchillos para amputación  
 Coltelli per amputazione



**COLLIN**

a	
13,0 cm, 5"	<b>KI-1001-57</b>
16,0 cm, 6 <sup>1</sup> / <sub>4</sub> "	<b>KI-1001-58</b>
19,0 cm, 7 <sup>1</sup> / <sub>2</sub> "	<b>KI-1001-59</b>
22,0 cm, 8 <sup>5</sup> / <sub>8</sub> "	<b>KI-1001-60</b>
28,0 cm, 11"	<b>KI-1001-61</b>

**CATLIN**

A	
16,0 cm, 6 <sup>1</sup> / <sub>4</sub> "	<b>KI-1001-62</b>
19,0 cm, 7 <sup>1</sup> / <sub>2</sub> "	<b>KI-1001-63</b>
22,0 cm, 8 <sup>5</sup> / <sub>8</sub> "	<b>KI-1001-64</b>

**LISTON**

A	
17,0 cm, 6 <sup>3</sup> / <sub>4</sub> "	<b>KI-1001-65</b>
20,0 cm, 8"	<b>KI-1001-66</b>
22,0 cm, 8 <sup>5</sup> / <sub>8</sub> "	<b>KI-1001-67</b>

Amputationsmesser, Messer für Autopsie  
 Amputation Knives, Post Mortem Knives  
 Cuchillos para amputación, Cuchillos para autopsia  
 Coltelli per amputazione, Coltelli per autopsia

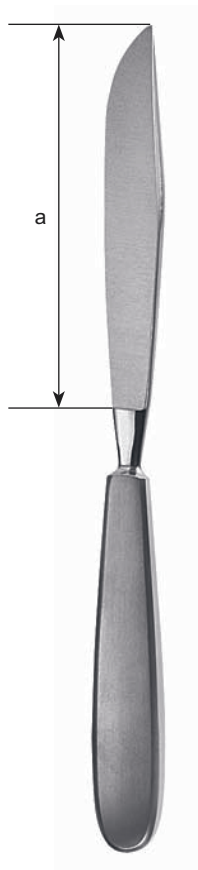

**LANGENBECK**  
 KI-1001-68

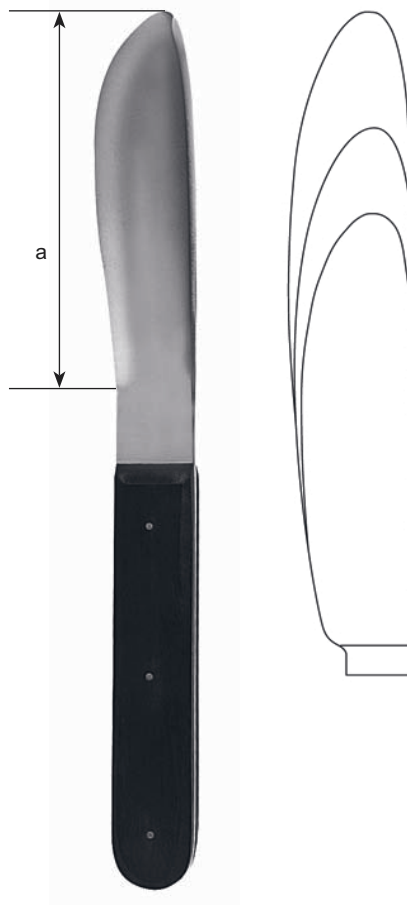

**WALB**

A	
11,0 cm, 4 1/2"	<b>KI-1001-69</b>
14,0 cm, 5 1/2"	<b>KI-1001-70</b>
17,0 cm, 6 3/4"	<b>KI-1001-71</b>

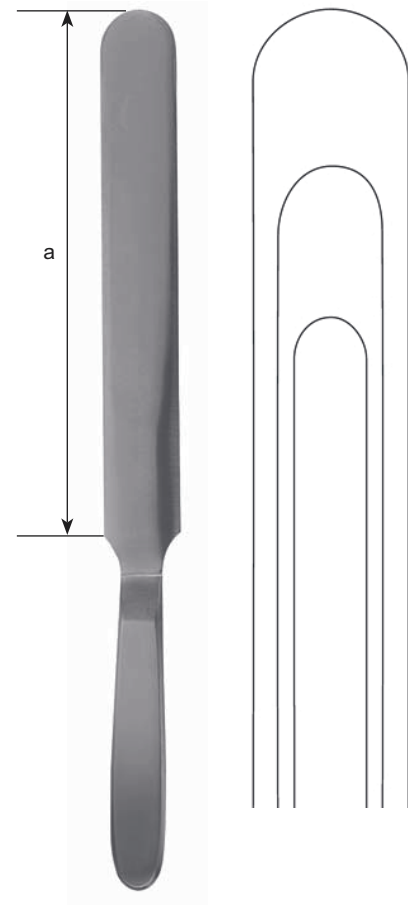

**VIRCHOW**

A	
16,0 cm, 6 1/4"	<b>KI-1001-72</b>
20,0 cm, 8"	<b>KI-1001-73</b>
24,0 cm, 9 1/2"	<b>KI-1001-74</b>

# General Surgery Instruments



"Supporting Healthcare"  
**KAAHA INDUSTRIES**  
Manufacturer Of Dental & Surgical Instruments

Amputationsmesser, Dermatome  
Amputation Knives, Dermatomes  
Cuchillos para amputación, Dermátomos  
Coltelli per amputazione, Dermatomi



**LANGENBECK**  
18,0 cm, 7"  
KI-1001-75



**CARTILAGE**  
17,5 cm, 6<sup>5</sup>/<sub>8</sub>"  
KI-1001-76

mit Schaber  
with raspatory  
con periostótomo  
con raschiatoio

Haut-Spannplatten  
Skin straightening plate  
Placa para extender la piel  
Placca per stendere la pelle



**KI-1001-77**

Resektionsmesser  
Resection Knives  
Cuchillos para resección  
Coltelli per resezione



**SILVER**  
19 cm, 7 1/2"  
KI-1001-78



**BRAITHWAITE**  
30,0 cm, 12"  
KI-1001-79



**HUMBY**  
35,0 cm, 14"  
KI-1001-80



**SCHINK**  
30,0 cm, 12"  
KI-1001-81



"Supporting Healthcare"

**KAAHA INDUSTRIES**

Manufacturer Of Dental & Surgical Instruments

**C2**

**14 to 62**



**Scheren**

**Scissors**

**Tijeras**

**Forbici**

# General Surgery Instruments



"Supporting Healthcare"  
**KAAHA INDUSTRIES**  
 Manufacturer Of Dental & Surgical Instruments

Chirurgische Scheren  
 Surgical Scissors  
 Tijeras para cirugía  
 Forbici per chirurgia



STANDARD	
10,5 cm, 4 <sup>1</sup> / <sub>4</sub> "	KI-1011-01
11,5 cm, 4 <sup>1</sup> / <sub>2</sub> "	KI-1011-02
13,0 cm, 5"	KI-1011-03
14,5 cm, 5 <sup>3</sup> / <sub>4</sub> "	KI-1011-04
15,5 cm, 6"	KI-1011-05
16,5 cm, 6 <sup>1</sup> / <sub>2</sub> "	KI-1011-06
17,5 cm, 6 <sup>5</sup> / <sub>8</sub> "	KI-1011-07
18,5 cm, 7 <sup>1</sup> / <sub>4</sub> "	KI-1011-08
20,0 cm, 8"	KI-1011-09

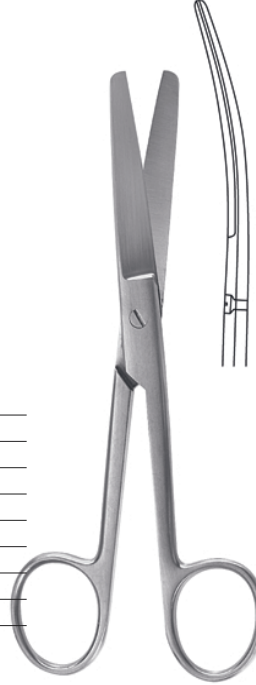

STANDARD	
10,5 cm, 4 <sup>1</sup> / <sub>4</sub> "	KI-1011-10
11,5 cm, 4 <sup>1</sup> / <sub>2</sub> "	KI-1011-11
13,0 cm, 5"	KI-1011-12
14,5 cm, 5 <sup>3</sup> / <sub>4</sub> "	KI-1011-13
15,5 cm, 6"	KI-1011-14
16,5 cm, 6 <sup>1</sup> / <sub>2</sub> "	KI-1011-15
17,5 cm, 6 <sup>5</sup> / <sub>8</sub> "	KI-1011-16
18,5 cm, 7 <sup>1</sup> / <sub>4</sub> "	KI-1011-17
20,0 cm, 8"	KI-1011-18



STANDARD	
10,5 cm, 4 <sup>1</sup> / <sub>4</sub> "	KI-1011-19
11,5 cm, 4 <sup>1</sup> / <sub>2</sub> "	KI-1011-20
13,0 cm, 5"	KI-1011-21
14,5 cm, 5 <sup>3</sup> / <sub>4</sub> "	KI-1011-22
15,5 cm, 6"	KI-1011-23
16,5 cm, 6 <sup>1</sup> / <sub>2</sub> "	KI-1011-24
17,5 cm, 6 <sup>5</sup> / <sub>8</sub> "	KI-1011-25
18,5 cm, 7 <sup>1</sup> / <sub>4</sub> "	KI-1011-26
20,0 cm, 8"	KI-1011-27



STANDARD	
10,5 cm, 4 <sup>1</sup> / <sub>4</sub> "	KI-1011-28
11,5 cm, 4 <sup>1</sup> / <sub>2</sub> "	KI-1011-29
13,0 cm, 5"	KI-1011-30
14,5 cm, 5 <sup>3</sup> / <sub>4</sub> "	KI-1011-31
15,5 cm, 6"	KI-1011-32
16,5 cm, 6 <sup>1</sup> / <sub>2</sub> "	KI-1011-33
17,5 cm, 6 <sup>5</sup> / <sub>8</sub> "	KI-1011-34
18,5 cm, 7 <sup>1</sup> / <sub>4</sub> "	KI-1011-35
20,0 cm, 8"	KI-1011-36



Chirurgische Scheren, Präparierscheren  
 Surgical Scissors, Dissecting Scissors  
 Tijeras para cirugía, Tijeras de disección  
 Forbici per chirurgia, Forbici per dissezione

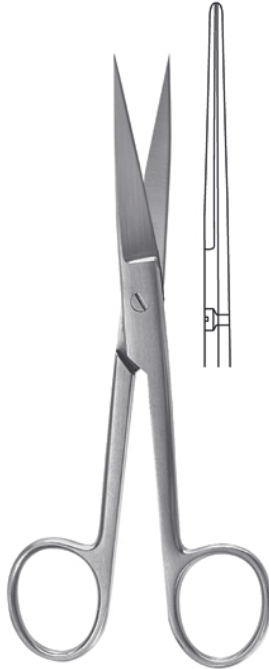

**STANDARD**

10,5 cm, 4 <sup>1</sup> / <sub>4</sub> "	<b>KI-1011-37</b>
11,5 cm, 4 <sup>1</sup> / <sub>2</sub> "	<b>KI-1011-38</b>
13,0 cm, 5"	<b>KI-1011-39</b>
14,5 cm, 5 <sup>3</sup> / <sub>4</sub> "	<b>KI-1011-40</b>
15,5 cm, 6"	<b>KI-1011-41</b>
16,5 cm, 6 <sup>1</sup> / <sub>2</sub> "	<b>KI-1011-42</b>
17,5 cm, 6 <sup>5</sup> / <sub>8</sub> "	<b>KI-1011-43</b>
18,5 cm, 7 <sup>1</sup> / <sub>4</sub> "	<b>KI-1011-44</b>
20,0 cm, 8"	<b>KI-1011-45</b>



**STANDARD**

10,5 cm, 4 <sup>1</sup> / <sub>4</sub> "	<b>KI-1011-46</b>
11,5 cm, 4 <sup>1</sup> / <sub>2</sub> "	<b>KI-1011-47</b>
13,0 cm, 5"	<b>KI-1011-48</b>
14,5 cm, 5 <sup>3</sup> / <sub>4</sub> "	<b>KI-1011-49</b>
15,5 cm, 6"	<b>KI-1011-50</b>
16,5 cm, 6 <sup>1</sup> / <sub>2</sub> "	<b>KI-1011-51</b>
17,5 cm, 6 <sup>5</sup> / <sub>8</sub> "	<b>KI-1011-52</b>
18,5 cm, 7 <sup>1</sup> / <sub>4</sub> "	<b>KI-1011-53</b>
20,0 cm, 8"	<b>KI-1011-54</b>



**DEAVER**

12,0 cm, 4 <sup>3</sup> / <sub>4</sub> "	<b>KI-1011-55</b>
13,0 cm, 5"	<b>KI-1011-56</b>
14,5 cm, 5 <sup>3</sup> / <sub>4</sub> "	<b>KI-1011-57</b>



**DEAVER**

12,0 cm, 4 <sup>3</sup> / <sub>4</sub> "	<b>KI-1011-58</b>
13,0 cm, 5"	<b>KI-1011-59</b>
14,5 cm, 5 <sup>3</sup> / <sub>4</sub> "	<b>KI-1011-60</b>

Präparierscheren  
 Dissecting Scissors  
 Tijeras de disección



**DEAVER**

12,0 cm, 4 <sup>3</sup> / <sub>4</sub> "	<b>KI-1011-61</b>
13,0 cm, 5"	<b>KI-1011-62</b>
14,5 cm, 5 <sup>3</sup> / <sub>4</sub> "	<b>KI-1011-63</b>



**DEAVER**

12,0 cm, 4 <sup>3</sup> / <sub>4</sub> "	<b>KI-1011-64</b>
13,0 cm, 5"	<b>KI-1011-65</b>
14,5 cm, 5 <sup>3</sup> / <sub>4</sub> "	<b>KI-1011-66</b>



**DEAVER**

12,0 cm, 4 <sup>3</sup> / <sub>4</sub> "	<b>KI-1011-67</b>
13,0 cm, 5"	<b>KI-1011-68</b>
14,5 cm, 5 <sup>3</sup> / <sub>4</sub> "	<b>KI-1011-69</b>



**DEAVER**

12,0 cm, 4 <sup>3</sup> / <sub>4</sub> "	<b>KI-1011-70</b>
13,0 cm, 5"	<b>KI-1011-71</b>
14,5 cm, 5 <sup>3</sup> / <sub>4</sub> "	<b>KI-1011-72</b>

Präparierscheren  
 Dissecting Scissors  
 Tijeras de disección  
 Forbici per dissezione



**GRAZIL**  
 13,0 cm, 5" **KI-1011-73**  
 14,5 cm, 5<sup>3</sup>/<sub>4</sub>" **KI-1011-74**



**GRAZIL**  
 13,0 cm, 5" **KI-1011-75**  
 14,5 cm, 5<sup>3</sup>/<sub>4</sub>" **KI-1011-76**



**GRAZIL**  
 13,0 cm, 5" **KI-1011-77**  
 14,5 cm, 5<sup>3</sup>/<sub>4</sub>" **KI-1011-78**



**GRAZIL**  
 13,0 cm, 5" **KI-1011-79**  
 14,5 cm, 5<sup>3</sup>/<sub>4</sub>" **KI-1011-80**

Präparierscheren  
 Dissecting Scissors  
 Tijeras de disección  
 Forbici per dissezione



**GRAZIL**

13,0 cm, 5"	<b>KI-1011-81</b>
14,5 cm, 5 <sup>3</sup> / <sub>4</sub> "	<b>KI-1011-82</b>



**GRAZIL**

13,0 cm, 5"	<b>KI-1011-83</b>
14,5 cm, 5 <sup>3</sup> / <sub>4</sub> "	<b>KI-1011-84</b>

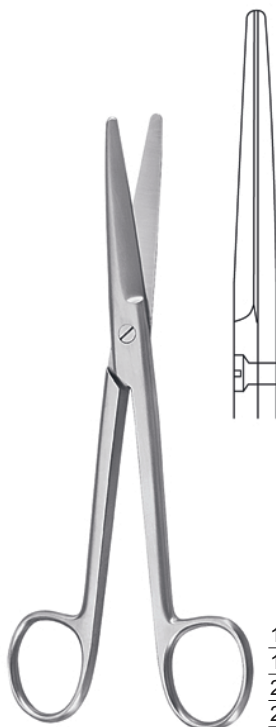

**MAYO**

14,5 cm, 5 <sup>3</sup> / <sub>4</sub> "	<b>KI-1011-85</b>
17,0 cm, 6 <sup>3</sup> / <sub>4</sub> "	<b>KI-1011-86</b>
23,0 cm, 9"	<b>KI-1011-87</b>
28,0 cm, 11"	<b>KI-1011-88</b>

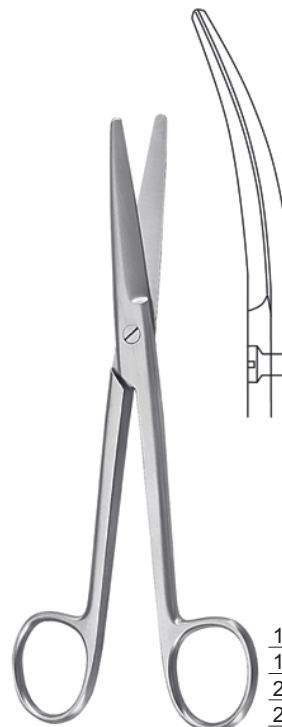

**MAYO**

14,5 cm, 5 <sup>3</sup> / <sub>4</sub> "	<b>KI-1011-89</b>
17,0 cm, 6 <sup>3</sup> / <sub>4</sub> "	<b>KI-1011-90</b>
23,0 cm, 9"	<b>KI-1011-91</b>
28,0 cm, 11"	<b>KI-1011-92</b>

Präparierscheren  
 Dissecting Scissors  
 Tijeras de disección  
 Forbici per dissezione



**MAYO-STILE**

15,0 cm, 6"	<b>KI-1011-93</b>
17,0 cm, 6 <sup>3</sup> / <sub>4</sub> "	<b>KI-1011-94</b>
19,5 cm, 7 <sup>3</sup> / <sub>4</sub> "	<b>KI-1011-95</b>
21,0 cm, 8 <sup>1</sup> / <sub>4</sub> "	<b>KI-1011-96</b>

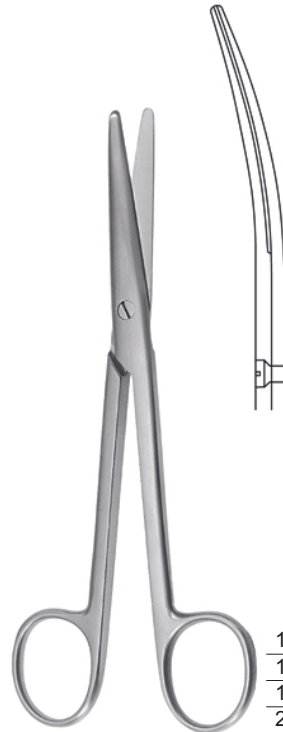

**MAYO-STILE**

15,0 cm, 6"	<b>KI-1011-97</b>
17,0 cm, 6 <sup>3</sup> / <sub>4</sub> "	<b>KI-1011-98</b>
19,5 cm, 7 <sup>3</sup> / <sub>4</sub> "	<b>KI-1011-99</b>
21,0 cm, 8 <sup>1</sup> / <sub>4</sub> "	<b>KI-1011-100</b>



**MAYO-NOBLE**  
 17,0 cm, 6<sup>3</sup>/<sub>4</sub>"

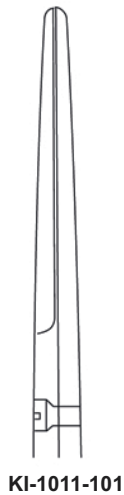

**FOMON**  
 13,5 cm, 5<sup>3</sup>/<sub>8</sub>" **KI-1011-103**

Präparierscheren  
 Dissecting Scissors  
 Tijeras de disección  
 Forbici per dissezione

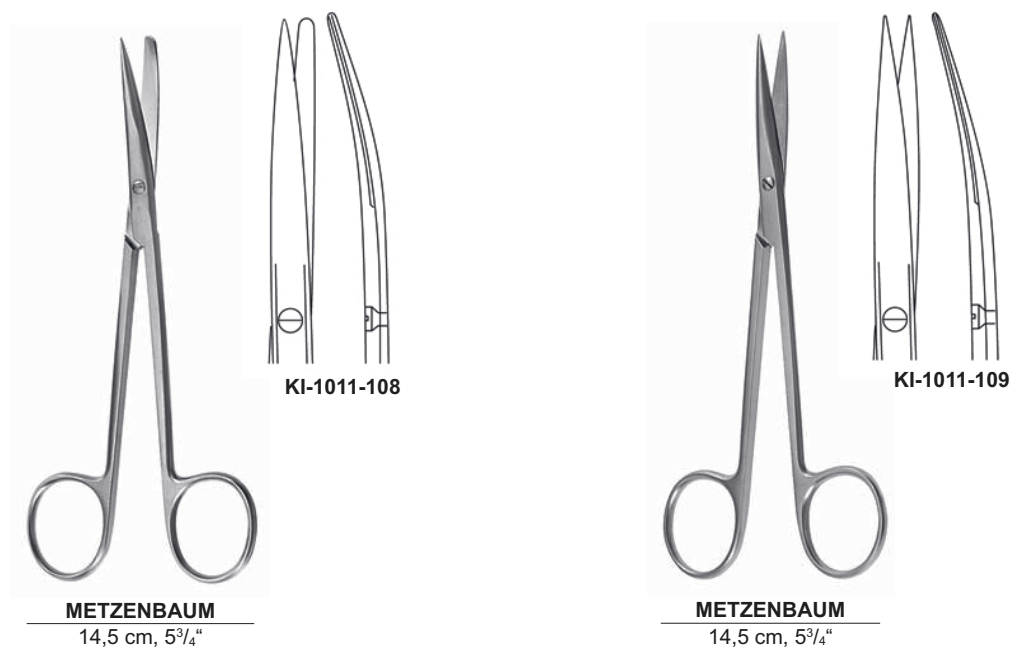
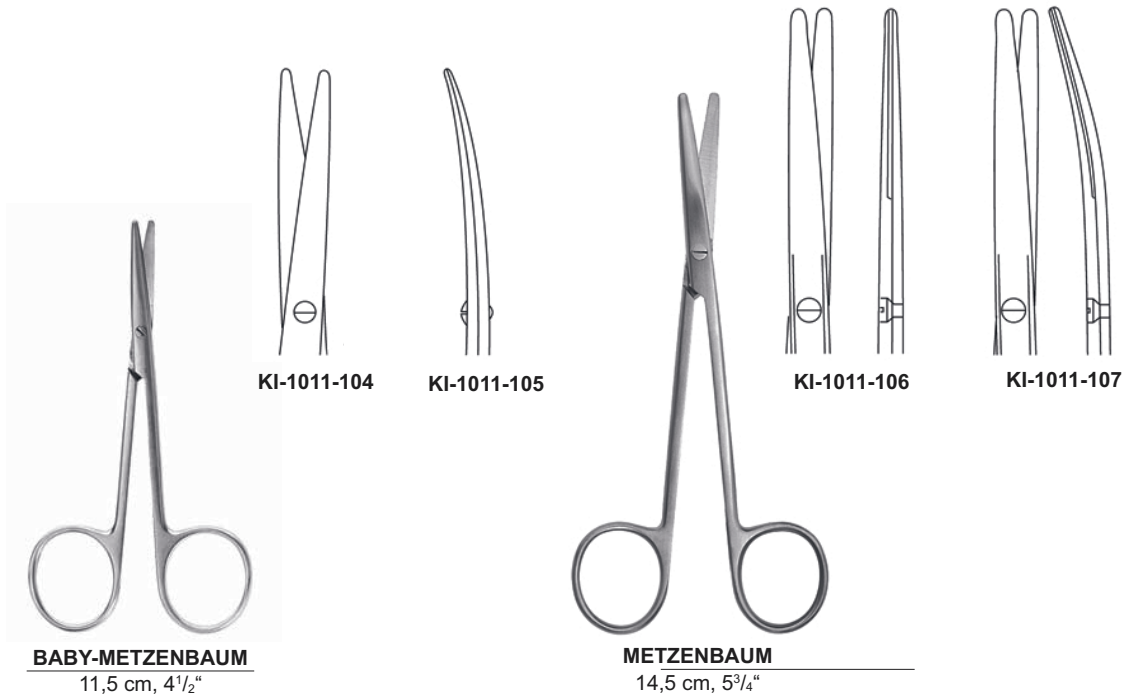

Präparierscheren  
 Dissecting Scissors  
 Tijeras de disección  
 Forbici per dissezione



**METZENBAUM**

18,0 cm, 7"	<b>KI-1011-110</b>
20,0 cm, 8"	<b>KI-1011-111</b>
23,0 cm, 9"	<b>KI-1011-112</b>
25,0 cm, 10"	<b>KI-1011-113</b>
28,0 cm, 11"	<b>KI-1011-114</b>
30,0 cm, 12"	<b>KI-1011-115</b>



**METZENBAUM**

18,0 cm, 7"	<b>KI-1011-116</b>
20,0 cm, 8"	<b>KI-1011-117</b>
23,0 cm, 9"	<b>KI-1011-118</b>
25,0 cm, 10"	<b>KI-1011-119</b>
28,0 cm, 11"	<b>KI-1011-120</b>
30,0 cm, 12"	<b>KI-1011-121</b>



**METZENBAUM**

18,0 cm, 7"	<b>KI-1011-122</b>
20,0 cm, 8"	<b>KI-1011-123</b>
23,0 cm, 9"	<b>KI-1011-124</b>
25,0 cm, 10"	<b>KI-1011-125</b>
28,0 cm, 11"	<b>KI-1011-126</b>
30,0 cm, 12"	<b>KI-1011-127</b>



**METZENBAUM**

18,0 cm, 7"	<b>KI-1011-128</b>
20,0 cm, 8"	<b>KI-1011-129</b>
23,0 cm, 9"	<b>KI-1011-130</b>
25,0 cm, 10"	<b>KI-1011-131</b>
28,0 cm, 11"	<b>KI-1011-132</b>
30,0 cm, 12"	<b>KI-1011-133</b>

Präparierscheren  
 Dissecting Scissors  
 Tijeras de disección  
 Forbici per dissezione



**METZENBAUM**

18,0 cm, 7"	<b>KI-1011-134</b>
20,0 cm, 8"	<b>KI-1011-135</b>
23,0 cm, 9"	<b>KI-1011-136</b>
25,0 cm, 10"	<b>KI-1011-137</b>
28,0 cm, 11"	<b>KI-1011-138</b>
30,0 cm, 12"	<b>KI-1011-139</b>

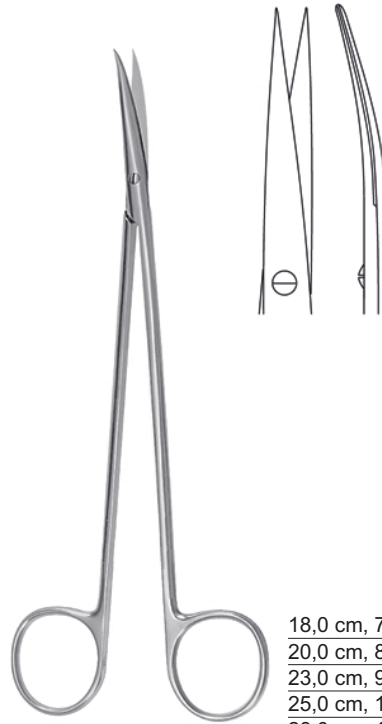

**METZENBAUM**

18,0 cm, 7"	<b>KI-1011-140</b>
20,0 cm, 8"	<b>KI-1011-141</b>
23,0 cm, 9"	<b>KI-1011-142</b>
25,0 cm, 10"	<b>KI-1011-143</b>
28,0 cm, 11"	<b>KI-1011-144</b>
30,0 cm, 12"	<b>KI-1011-145</b>



**METZENBAUM-FINO**

14,5 cm, 5<sup>3</sup>/<sub>4</sub>"

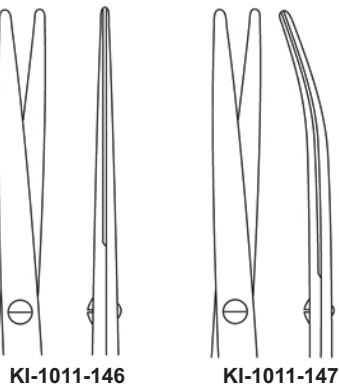

**KI-1011-146**

**KI-1011-147**



**METZENBAUM-FINO**

18,0 cm, 7"	<b>KI-1011-148</b>
20,0 cm, 8"	<b>KI-1011-149</b>
23,0 cm, 9"	<b>KI-1011-150</b>
25,0 cm, 10"	<b>KI-1011-151</b>
28,0 cm, 11"	<b>KI-1011-152</b>
30,0 cm, 12"	<b>KI-1011-153</b>



Präparierscheren  
 Dissecting Scissors  
 Tijeras de disección  
 Forbici per dissezione

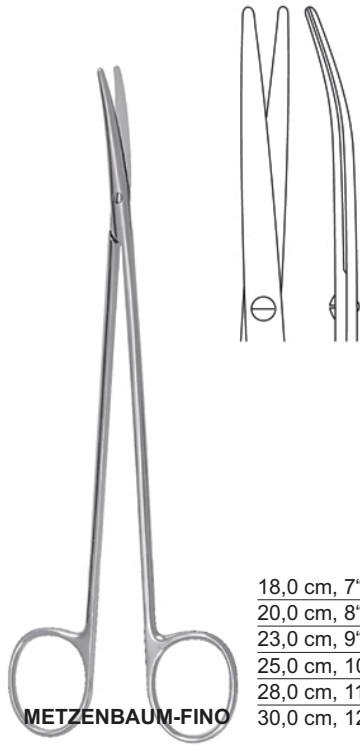

- |              |                    |
|--------------|--------------------|
| 18,0 cm, 7"  | <b>KI-1011-154</b> |
| 20,0 cm, 8"  | <b>KI-1011-155</b> |
| 23,0 cm, 9"  | <b>KI-1011-156</b> |
| 25,0 cm, 10" | <b>KI-1011-157</b> |
| 28,0 cm, 11" | <b>KI-1011-158</b> |
| 30,0 cm, 12" | <b>KI-1011-159</b> |

**METZENBAUM-FINO**



**KI-1011-160**

**METZENBAUM-FINO**

14,5 cm, 5¾"



**KI-1011-161**

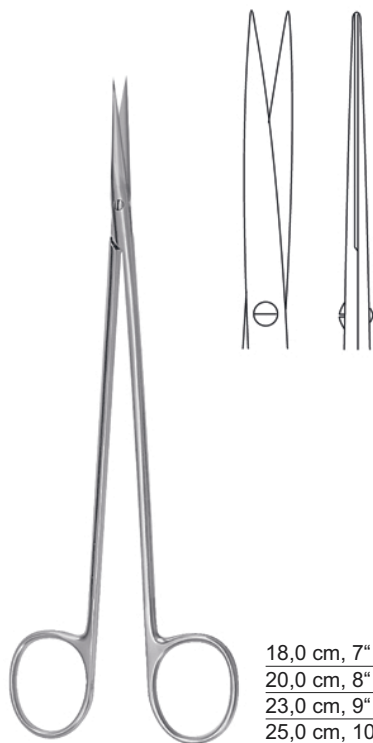

- |              |                    |
|--------------|--------------------|
| 18,0 cm, 7"  | <b>KI-1011-162</b> |
| 20,0 cm, 8"  | <b>KI-1011-163</b> |
| 23,0 cm, 9"  | <b>KI-1011-164</b> |
| 25,0 cm, 10" | <b>KI-1011-165</b> |
| 28,0 cm, 11" | <b>KI-1011-166</b> |
| 30,0 cm, 12" | <b>KI-1011-167</b> |

**METZENBAUM-FINO**



- |              |                    |
|--------------|--------------------|
| 18,0 cm, 7"  | <b>KI-1011-168</b> |
| 20,0 cm, 8"  | <b>KI-1011-169</b> |
| 23,0 cm, 9"  | <b>KI-1011-170</b> |
| 25,0 cm, 10" | <b>KI-1011-171</b> |
| 28,0 cm, 11" | <b>KI-1011-172</b> |
| 30,0 cm, 12" | <b>KI-1011-173</b> |

**METZENBAUM-FINO**

Präparierscheren  
 Dissecting Scissors  
 Tijeras de disección  
 Forbici per dissezione

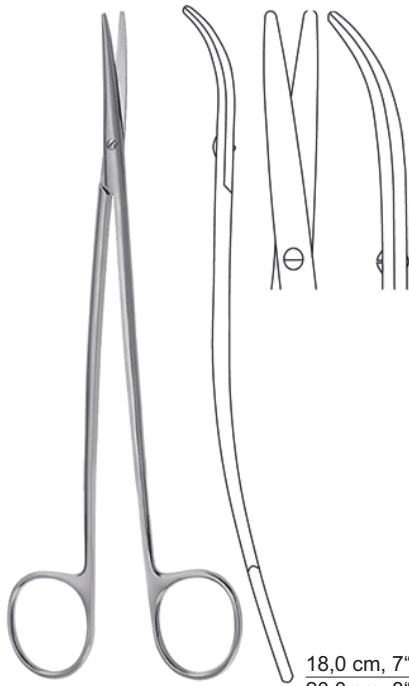

**METZENBAUM-FINO S**

18,0 cm, 7"	<b>KI-1011-174</b>
20,0 cm, 8"	<b>KI-1011-175</b>
23,0 cm, 9"	<b>KI -1011-176</b>

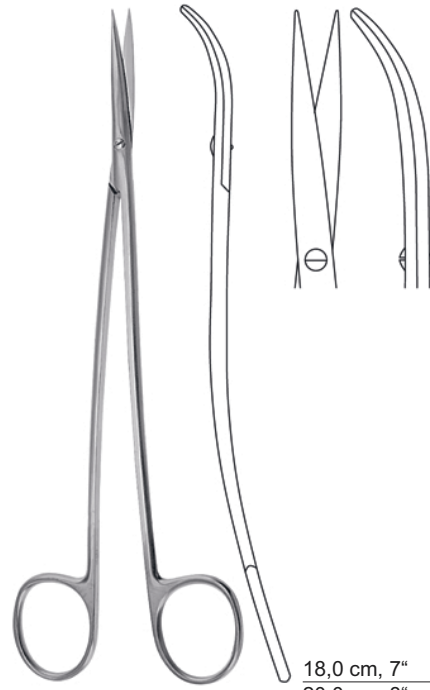

**METZENBAUM-FINOS**

18,0 cm, 7"	<b>KI-1011-177</b>
20,0 cm, 8"	<b>KI-1011-178</b>
23,0 cm, 9"	<b>KI-1011-179</b>



**METZENBAUM-LAHEY**  
 14,0 cm, 5 1/2" **KI-1011-180**

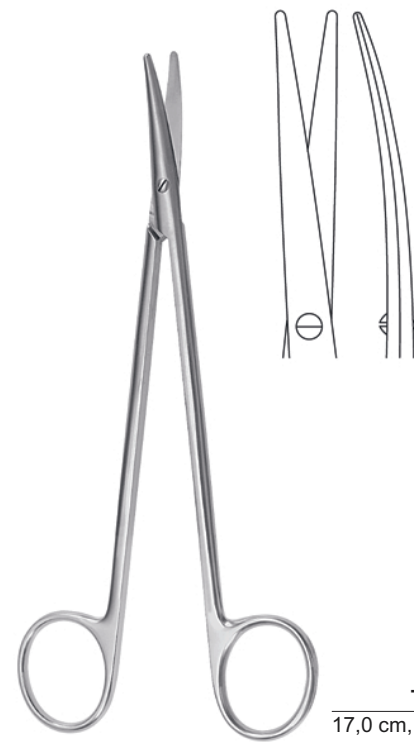

**TOENNIS-ADSON**  
 17,0 cm, 6 3/4" **KI-1011-181**

Präparierscheren  
 Dissecting Scissors  
 Tijeras de disección  
 Forbici per dissezione



KI-1011-182

KI-1011-183

**BABY-LEXER**

10,0 cm, 4"



**LEXER**

16,0 cm, 6<sup>1</sup>/<sub>4</sub>"

21,0 cm, 8<sup>1</sup>/<sub>4</sub>"

**KI-1011-184**

**KI-1011-185**



**LEXER**

16,0 cm, 6<sup>1</sup>/<sub>4</sub>"

21,0 cm, 8<sup>1</sup>/<sub>4</sub>"

**KI-1011-186**

**KI-1011-187**

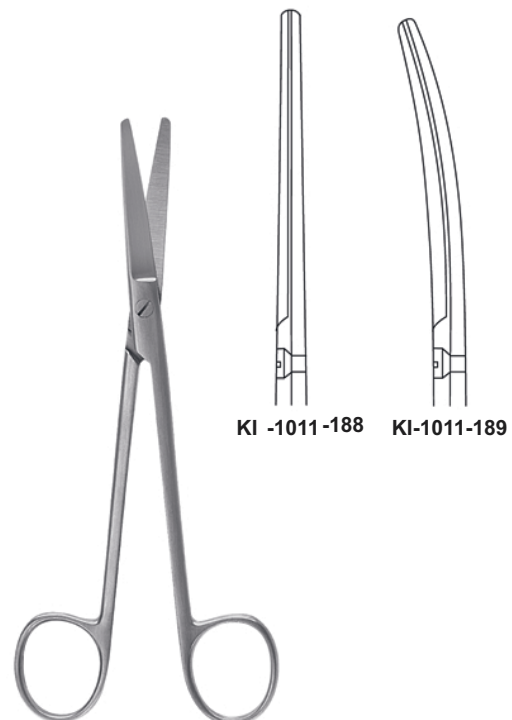

**KI -1011 -188**

**KI-1011-189**

**MIXTER**

17,0 cm, 6<sup>3</sup>/<sub>4</sub>"

# General Surgery Instruments



"Supporting Healthcare"  
**KAHA INDUSTRIES**  
 Manufacturer Of Dental & Surgical Instruments

Präparierscheren, feine chirurgische Scheren  
 Dissecting Scissors, fine surgical scissors  
 Tijeras de disección, tijeras finas para cirugía  
 Forbici per dissezione, forbici fine per chirurgia



**KILNER (RAGNELL)**

12,0 cm, 4 <sup>3</sup> / <sub>4</sub> "	<b>KI-1011-190</b>
15,0 cm, 6"	<b>KI-1011-191</b>
18,0 cm, 7"	<b>KI-1011-192</b>
20,0 cm, 8"	<b>KI-1011-193</b>



**KILNER (RAGNELL)**

12,0 cm, 4 <sup>3</sup> / <sub>4</sub> "	<b>KI-1011-194</b>
15,0 cm, 6"	<b>KI-1011-195</b>
18,0 cm, 7"	<b>KI-1011-196</b>
20,0 cm, 8"	<b>KI-1011-197</b>



**REYNOLDS**

15,0 cm, 6"	<b>KI-1011-198</b>
18,0 cm, 7"	<b>KI-1011-199</b>



**REYNOLDS**

15,0 cm, 6"	<b>KI-1011-200</b>
18,0 cm, 7"	<b>KI-1011-201</b>
20,0 cm, 8"	<b>KI-1011-202</b>
23,0 cm, 9"	<b>KI-1011-203</b>
25,0 cm, 10"	<b>KI-1011-204</b>

Feine chirurgische Scheren  
 Fine surgical scissors  
 Tijeras finas para cirugía  
 Forbici fine per chirurgia

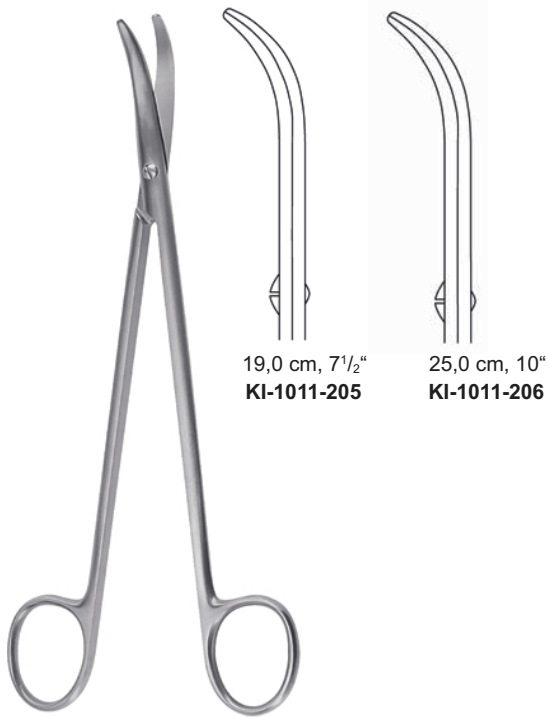

**THOREK**



15,0 cm, 6"

Nerv-Präparierscheren  
 Nerve dissecting scissors  
 Tijeras para nervios  
 Forbici per dissezione di nervi

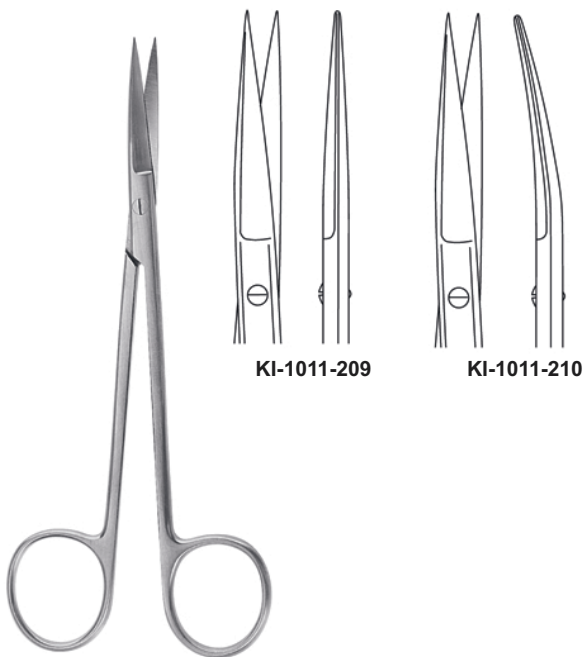

**SANVENERO**  
 14,0 cm, 5 1/2"

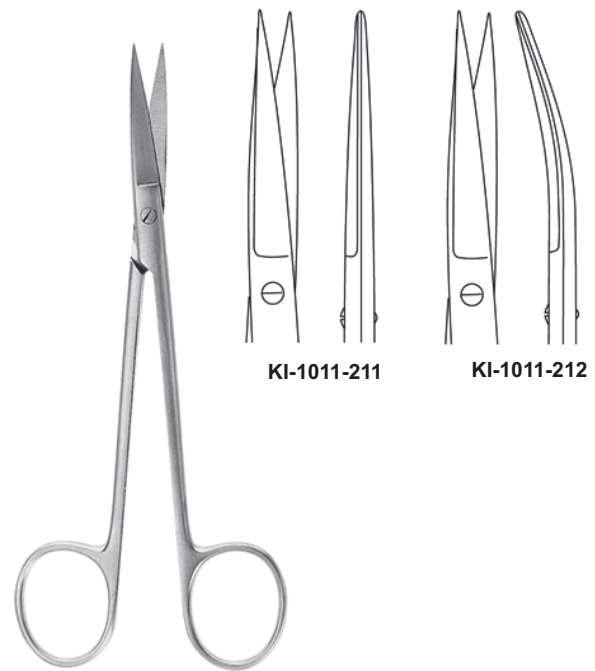

**JOSEPH**  
 14,0 cm, 5 1/2"

Feine chirurgische Scheren  
 Fine surgical scissors  
 Tijeras finas para cirugía  
 Forbici fine per chirurgia



**WAGNER**  
 12,0 cm, 4<sup>3</sup>/<sub>4</sub>"

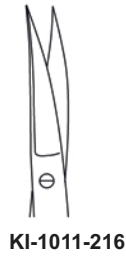
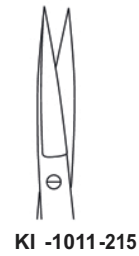
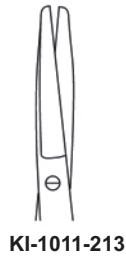

**STRABISMUS**  
 11,5 cm, 4<sup>1</sup>/<sub>2</sub>"

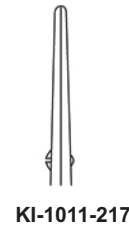

**IRIS**

9,0 cm, 4<sup>1</sup>/<sub>8</sub>" **KI-1011-219**  
 10,5 cm, 4<sup>1</sup>/<sub>8</sub>" **KI-1011-220**  
 11,5 cm, 4<sup>1</sup>/<sub>2</sub>" **KI-1011-221**



**IRIS**

9,0 cm, 4<sup>1</sup>/<sub>8</sub>" **KI-1011-222**  
 10,5 cm, 4<sup>1</sup>/<sub>8</sub>" **KI-1011-223**  
 11,5 cm, 4<sup>1</sup>/<sub>2</sub>" **KI-1011-224**

Feine chirurgische Scheren  
 Fine surgical scissors  
 Tijeras finas para cirugía  
 Forbici fine per chirurgia



IRIS

10,5 cm, 4<sup>1</sup>/<sub>8</sub>"  
 11,5 cm, 4<sup>1</sup>/<sub>2</sub>"

KI-1011-225  
 KI-1011-226



IRIS

10,5 cm, 4<sup>1</sup>/<sub>8</sub>"  
 11,5 cm, 4<sup>1</sup>/<sub>2</sub>"

KI-1011-227  
 KI-1011-228



11,5 cm, 4<sup>1</sup>/<sub>2</sub>"  
 KI-1011-229



11,5 cm, 4<sup>1</sup>/<sub>2</sub>"  
 KI-1011-230

# General Surgery Instruments



"Supporting Healthcare"  
**KAAHA INDUSTRIES**  
Manufacturer Of Dental & Surgical Instruments

Feine chirurgische Scheren  
Fine surgical scissors  
Tijeras finas para cirugía  
Forbici fine per chirurgia



KI-1011-231

12,0 cm, 4<sup>3</sup>/<sub>4</sub>"



KI-1011-232



MOD. BONN  
8,0 cm, 3<sup>1</sup>/<sub>4</sub>"  
KI-1011-233



MOD. BONN  
8,0 cm, 3<sup>1</sup>/<sub>4</sub>"  
KI-1011-234



MOD. BONN  
8,0 cm, 3<sup>1</sup>/<sub>4</sub>"  
KI-1011-235



Feine chirurgische Scheren  
 Fine surgical scissors  
 Tijeras finas para cirugía  
 Forbici fine per chirurgia

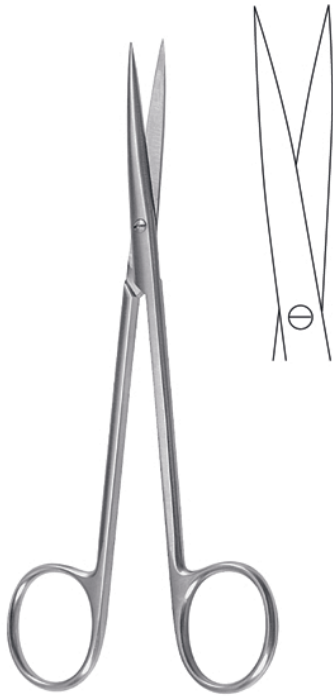

**BROPHY (SULLIVAN)**  
 14,0 cm, 5 1/2"  
 KI-1011-236



**BROPHY (SULLIVAN)**  
 14,0 cm, 5 1/2"  
 KI-1011-237

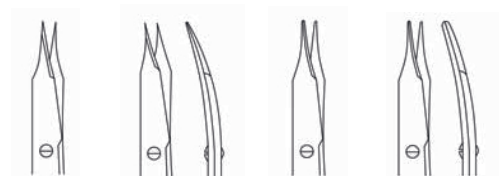

10,5 cm, 4 1/8"	KI-1011-241	KI-1011-243	KI-1011-245	KI-1011-247
11,5 cm, 4 1/2"	KI-1011-242	KI-1011-244	KI-1011-246	KI-1011-248

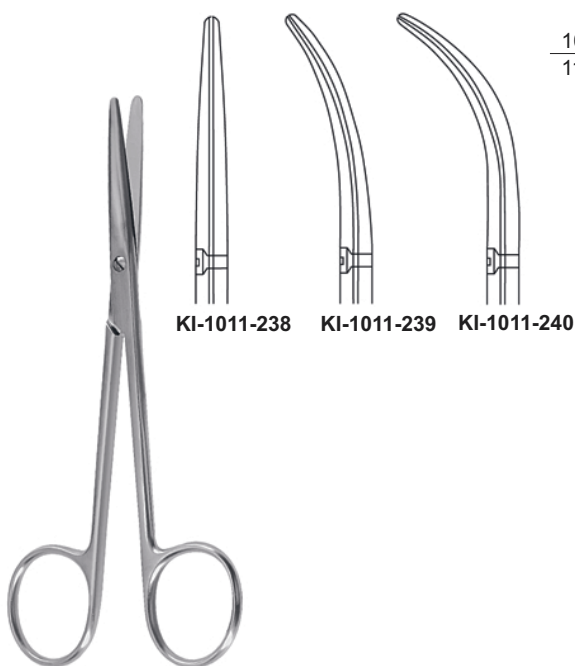

**LANDOLT**  
 12,5 cm, 5"



**STEVENS**

Chirurgische Scheren  
 Surgical scissors  
 Tijeras para cirugía  
 Forbici per chirurgia



Inzisionsscheren  
 Incision scissors  
 Tijeras para incisión  
 Forbici vascolare e per fistole

13,0 cm, 5" **KI-1011-249**  
 14,5 cm, 5¾" **KI-1011-250**



Inzisionsscheren  
 Incision scissors  
 Tijeras para incisión  
 Forbici vascolare e per fi stole

**KI-1011-251**  
 16,5 cm, 36½"



**RICHTER**  
 14,5 cm, 5¾"  
**KI-1011-252**



**LAWSON TAIT**  
 12,5 cm, 5"  
**KI-1011-253**



**FERGUSON**  
 16,5 cm, 6¼" **KI-1011-254**  
 18,0 cm, 7" **KI-1011-255**



**TOENNIS**  
 18,0 cm, 7"  
**KI-1011-256**

Chirurgische Scheren, Ligaturscheren  
 Surgical scissors, Ligature Scissors  
 Tijeras para cirugía, Tijeras para ligaduras  
 Forbici per chirurgia, Forbici per legature



**TOENNIS**  
 18,0 cm, 7"  
 KI-1011-257



**HALLE**  
 19,0 cm, 7½"  
 KI-1011-258



**FOMON**  
 15,0 cm, 6"  
 KI-1011-259



**SPENCER**  
 9,0 cm, 4⅛"  
 10,5 cm, 4⅛"  
 13,0 cm, 5"  
 KI-1011-260  
 KI-1011-261  
 KI-1011-262



**LITTAUER**  
 11,5 cm, 4¼"  
 14,0 cm, 5½"  
 KI-1011-263  
 KI-1011-264

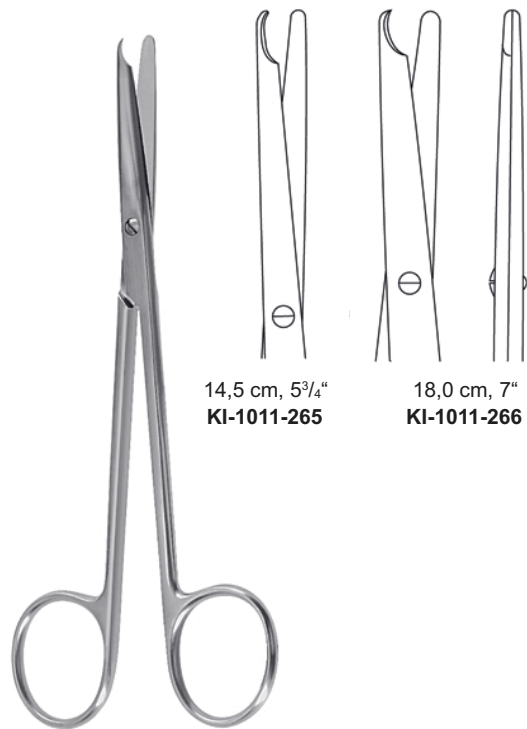

14,5 cm, 5¾"  
 KI-1011-265

18,0 cm, 7"  
 KI-1011-266

**BUCK**

# General Surgery Instruments



"Supporting Healthcare"  
**KAAHA INDUSTRIES**  
 Manufacturer Of Dental & Surgical Instruments

Ligaturscheren, Neurochirurgische Scheren  
 Ligature Scissors, Neurosurgical Scissors  
 Tijeras para ligaduras, Tijeras para Neurocirugía  
 Forbici per legature, Forbici per Neurochirurgia

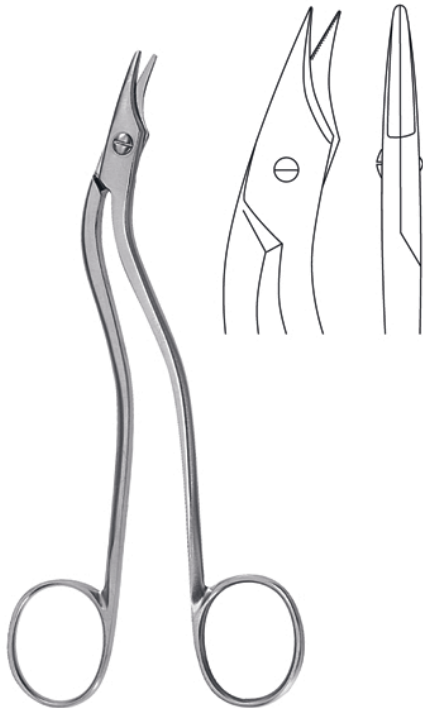

**HEATH**  
 16,0 cm, 6<sup>1</sup>/<sub>4</sub>"  
 KI-1011-267



**NORTHBENT**  
 9,0 cm, 3<sup>1</sup>/<sub>2</sub>"  
 KI-1011-268



**NORTHBENT**  
 13,0 cm, 5"  
 KI-1011-269



**EISELSBERG**  
 12,0 cm, 4<sup>3</sup>/<sub>4</sub>"  
 KI-1011-270

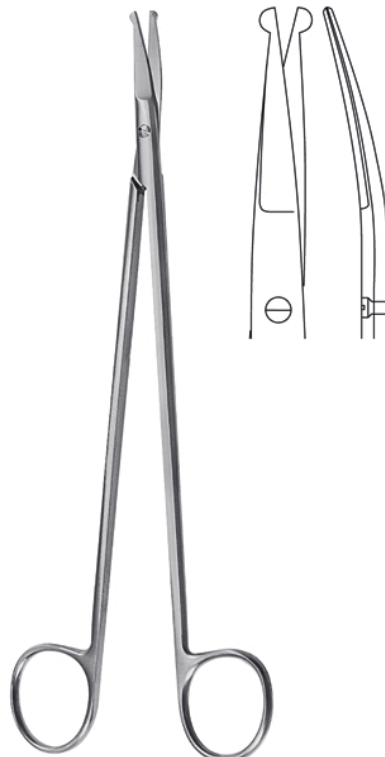

**STRULLY**  
 22,0 cm, 8<sup>5</sup>/<sub>8</sub>"  
 KI-1011-271

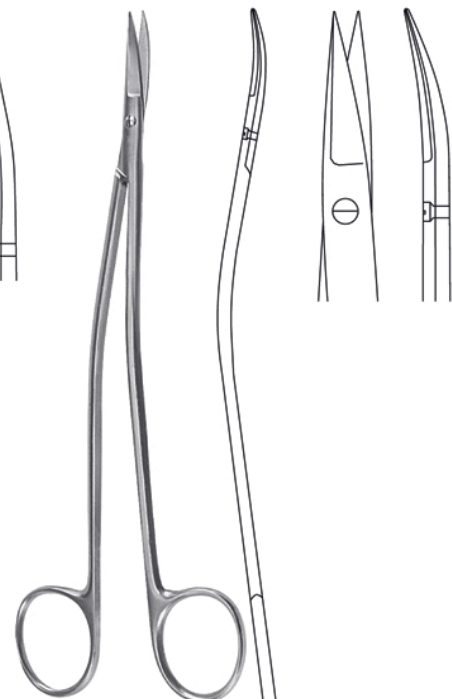

**DANDY**  
 17,0 cm, 6<sup>3</sup>/<sub>4</sub>"  
 KI-1011-272

Neurochirurgische Scheren, Tonsillenscheren, Nasenscheren  
 Neurosurgical Scissors, Tonsil Scissors, Nasal Scissors  
 Tijeras para Neurocirugía, Tijeras para amígdalas, Tijeras para el tabique nasal  
 Forbici per Neurochirurgia, Forbici per tonsille, Forbici per il setto nasale

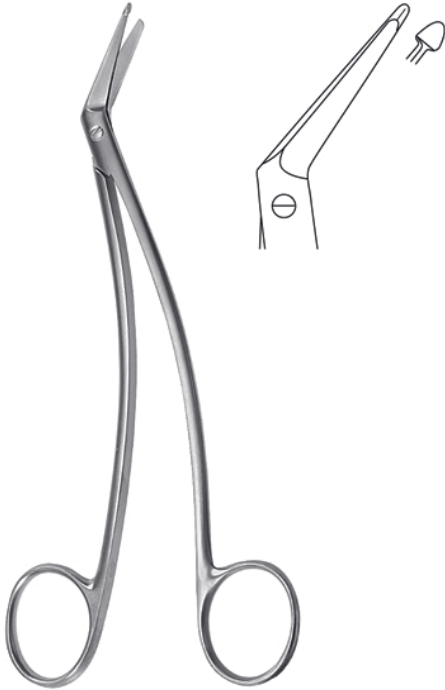

**SCHMIEDEN-TAYLOR**  
 17,0 cm, 6<sup>3</sup>/<sub>4</sub>"  
 KI-1011-273

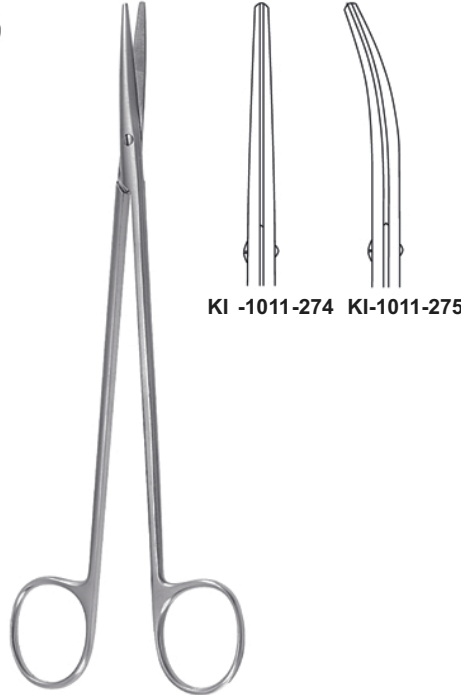

**LINCOLN**  
 17,0 cm, 6<sup>3</sup>/<sub>4</sub>"



**HEYMANN**  
 18,0 cm, 7"  
 KI-1011-276



**COTTLE**  
 16,0 cm, 6<sup>1</sup>/<sub>4</sub>"  
 KI-1011-277

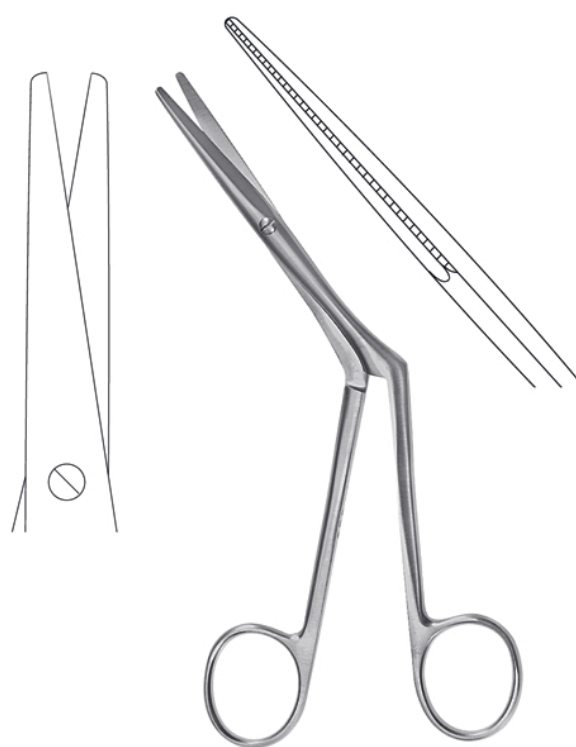

**KIRSTEN**  
 18,0 cm, 7"  
 KI-1011-278



**CAPLAN**  
 22,0 cm, 8<sup>5</sup>/<sub>8</sub>"  
 KI-1011-279

Tonsillenscheren, Nasenscheren, Gefäßscheren  
 Tonsil Scissors, Nasal Scissors, Vascular Scissors  
 Tijeras para amígdalas, Tijeras para el tabique nasal, Tijeras vasculares  
 Forbici per tonsille, Forbici per il setto nasale, Forbici vascolari



**BOETTCHER**  
 18,0 cm, 7"  
 KI-1011-280

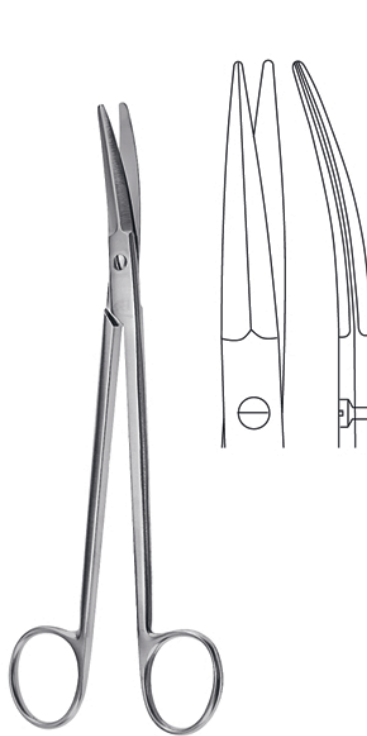

**PRINCE**  
 17,5 cm, 6<sup>5</sup>/<sub>8</sub>"  
 KI-1011-281

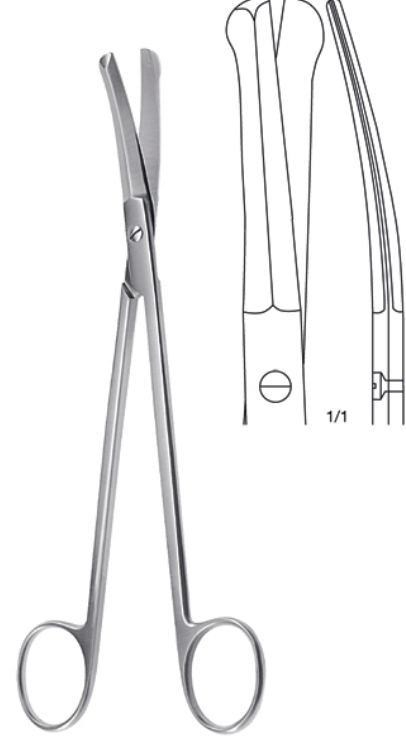

**GOOD**  
 19,0 cm, 7<sup>1</sup>/<sub>2</sub>"  
 KI-1011-282



**CARTILAGE**  
 20,0 cm, 8"  
 KI-1011-283



**DE BAKEY**

17,5 cm, 6 <sup>5</sup> / <sub>8</sub> "	KI-1011-284	KI-1011-289
19,5 cm, 7 <sup>3</sup> / <sub>4</sub> "	KI-1011-285	KI-1011-290
21,0 cm, 8 <sup>1</sup> / <sub>4</sub> "	KI-1011-286	KI-1011-291
23,0 cm, 9"	KI-1011-287	KI-1011-292
28,0 cm, 11"	KI-1011-288	KI-1011-293
		KI-1011-294
		KI-1011-295
		KI-1011-296
		KI-1011-297
		KI-1011-298

Gefäßscheren  
 Vascular Scissors  
 Tijeras vasculares  
 Forbici vascolari

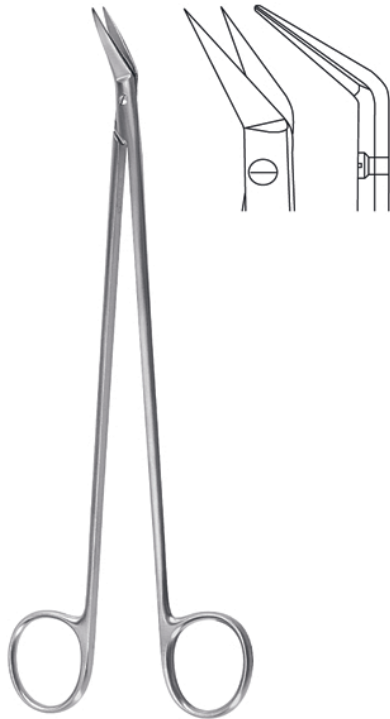

**POTTS-SMITH**  
 18,0 cm, 7"  
 KI-1011-299

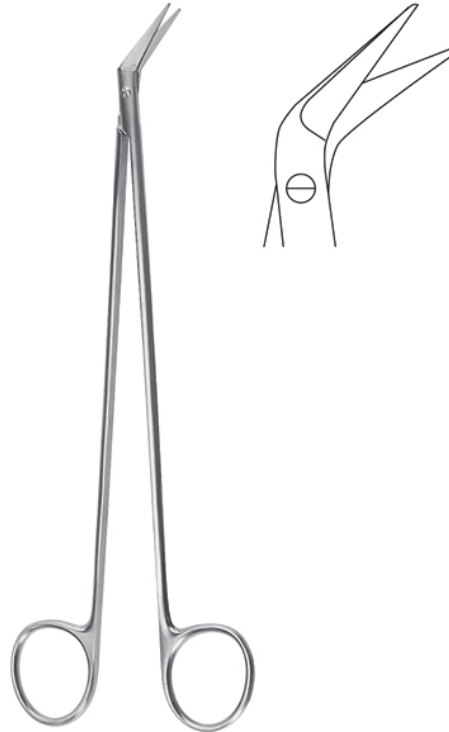

**POTTS DE MARTEL**  
 21,0 cm, 8<sup>1</sup>/<sub>4</sub>"      KI-1011-300  
 24,0 cm, 9<sup>1</sup>/<sub>2</sub>"      KI-1011-301



**DIETRICH-HEGEMANN**  
 19,0 cm, 7<sup>1</sup>/<sub>2</sub>"

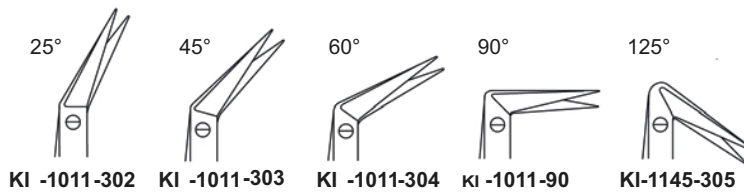

Gefäßscheren  
 Vascular Scissors  
 Tijeras vasculares  
 Forbici vascolari



**DIETRICH**  
 20,0 cm, 7 1/2"  
**KI-1011-306**

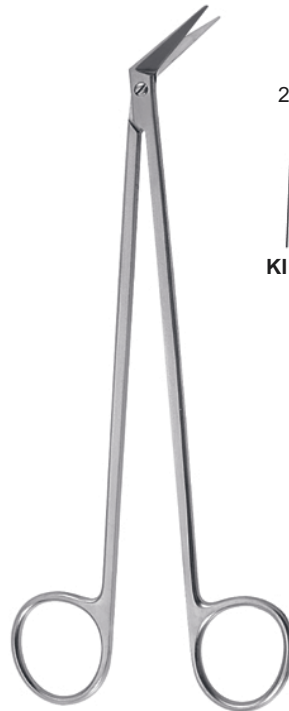

**POTTS-SMITH**  
 19,0 cm, 7 1/2"

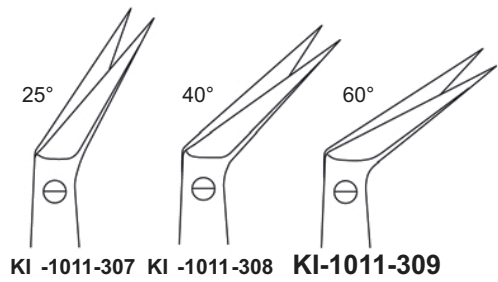

**KI -1011-307**   **KI -1011-308**   **KI-1011-309**

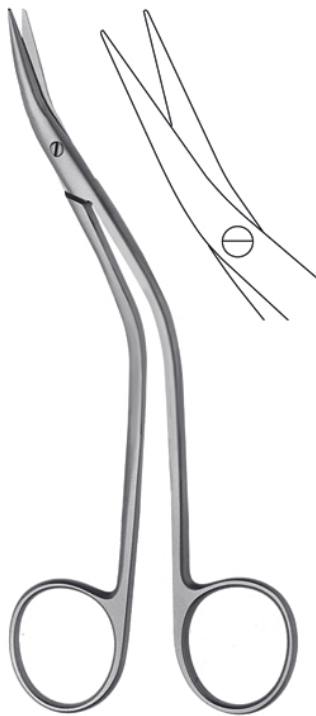

**DE BAKAY**  
 15,5 cm, 6"  
**KI-1011-310**

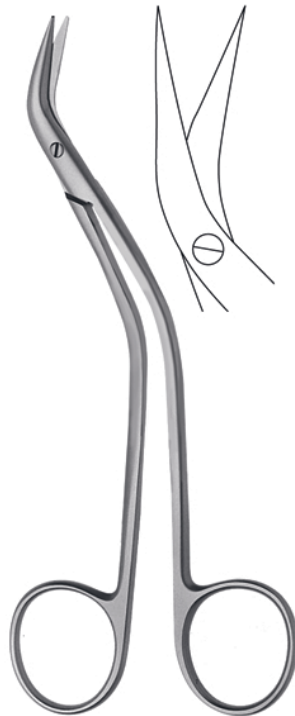

**DE BAKAY**  
 15,5 cm, 6"  
**KI-1011-311**



**DE BAKAY**  
 15,5 cm, 6"  
**KI-1011-312**



Gefäßscheren, Gynäkologische Scheren  
 Vascular Scissors, Gynecology scissors  
 Tijeras vasculares, Tijeras para ginecología  
 Forbici vascolari, Forbici per ginecologia



**MC INDOE**  
 19,0 cm, 7½"  
**KI-1011-313**



11,5 cm, 4½"  
**KI-1011-314**

geknöpftes Blatt  
 probe-pointed blade  
 punta botonda  
 lame bottonuta



**CRAFOORD**  
 30,0 cm, 12"  
**KI-1011-315**



**SATINSKY**  
 15,5 cm, 9⅝"  
**KI-1011-316**



**KLINGENBERG-LOTH**  
 23,0 cm, 9"  
**KI-1011-317**



**SIMS**

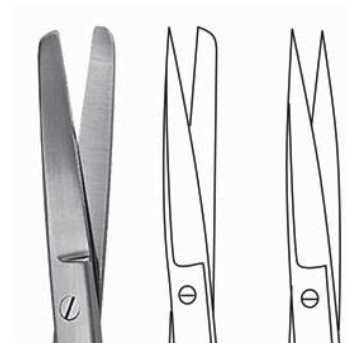

20,0 cm, 8"    **KI -1011-318**    **KI-1011-320**    **KI -1011-322**  
 23,0 cm, 9"    **KI -1011-319**    **KI-1011-321**    **KI 1011-323**

Gynäkologische Scheren  
 Gynecology scissors  
 Tijeras para ginecología  
 Forbici per ginecologia



**SIMS**

20,0 cm, 8"  
 23,0 cm, 9"



**KI-1011-324** **KI-1011-326** **KI-1011-28**  
**KI-1011-325** **KI-1011-327** **KI-1011-329**



**SIEBOLD**  
 24,0 cm, 9 1/2"  
**KI-1011-330**



**BOZEMANN**  
 22,0 cm, 8 3/4"  
**KI-1011-331**



**DOYEN**

16,0 cm, 6 1/4" **KI-1011-332** **KI-1011-334** **KI-1011-336**  
 17,5 cm, 6 5/8" **KI-1011-333** **KI-1011-335** **KI-1011-337**



**KELLY**

16,0 cm, 6 1/4" **KI-1011-338**  
 18,0 cm, 7" **KI-1011-339**

Fistelscheren  
 Fistula scissors  
 Tijeras para fistulas  
 Forbici per fistole

Gynäkologische Scheren, Darmscheren  
 Gynecology scissors, Enterotomy Scissors  
 Tijeras para ginecología, Tijeras enterótomos  
 Forbici per ginecologia, Forbici per enterotomia



Fistelscheren  
 Fistula scissors  
 Tijeras para fistulas  
 Forbici per fistole

**KELLY**

16,0 cm, 6<sup>1</sup>/<sub>4</sub>" **KI-1011-340**  
 18,0 cm, 7" **KI-1011-341**



**WERTHEIM**

19,5 cm, 7<sup>3</sup>/<sub>4</sub>" **KI-1011-342**  
 22,5 cm, 8<sup>3</sup>/<sub>4</sub>" **KI-1011-343**



**KI-1178-18**

**DUBOIS**

27,0 cm, 10<sup>5</sup>/<sub>8</sub>"  
**KI-1011-344**



**DARMSCHERE**  
 21,0 cm, 8<sup>1</sup>/<sub>4</sub>"  
**KI-1011-345**



**DARMSCHERE**  
 21,0 cm, 8<sup>1</sup>/<sub>4</sub>"  
**KI-1011-346**



**DARMSCHERE**  
**GEKNÖPFT**  
 21,0 cm, 8<sup>1</sup>/<sub>4</sub>"  
**KI-1011-347**



**LLOYD-DAVIES**  
 27,0 cm, 10<sup>5</sup>/<sub>8</sub>"  
**KI-1011-348**



# General Surgery Instruments



"Supporting Healthcare"  
**KAHA INDUSTRIES**  
 Manufacturer Of Dental & Surgical Instruments

Lungenlappen- und Rektumscheren, Lungenscheren, Dammscheren  
 Lobectomy and Rectal Scissors, Lobectomy Scissors, Episiotomy Scissors  
 Tijeras para lobectomía y recto, Tijera para lobectomía, Tijeras para episiotomía  
 Forbici per lobo polmonare e per il retto, Forbici per lobo, Forbici per episiotomia

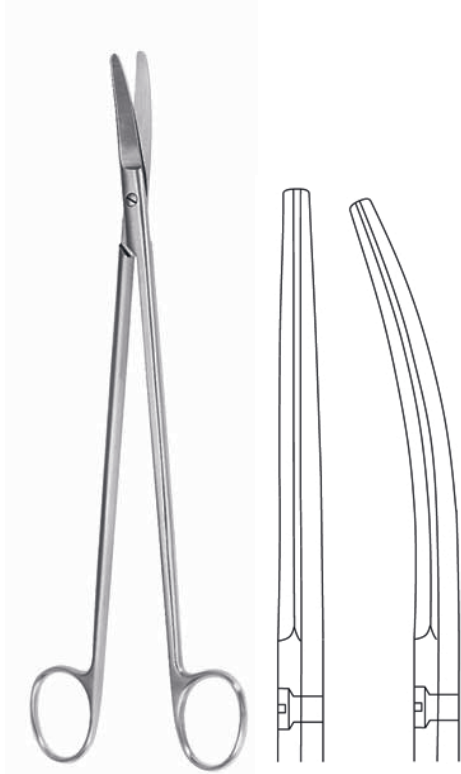

**STELZNER**  
 31,0 cm, 12<sup>3</sup>/<sub>4</sub>"

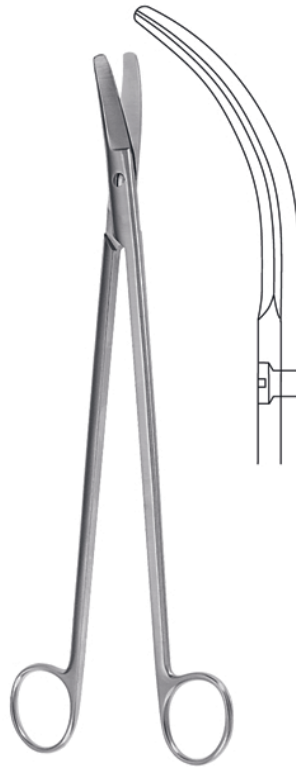

**RECTAL**  
 32,5 cm, 12<sup>3</sup>/<sub>4</sub>"  
**KI-1011-351**

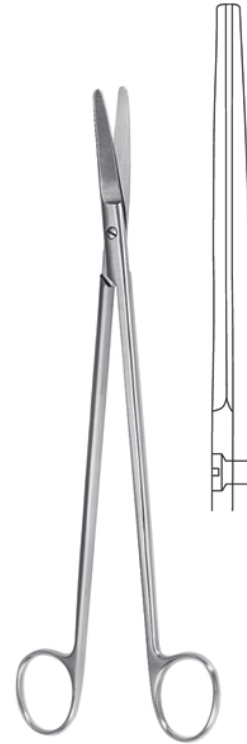

**WILLAUER**  
 25,0 cm, 9<sup>3</sup>/<sub>4</sub>" **KI-1011-352**  
 28,0 cm, 11" **KI-1011-353**

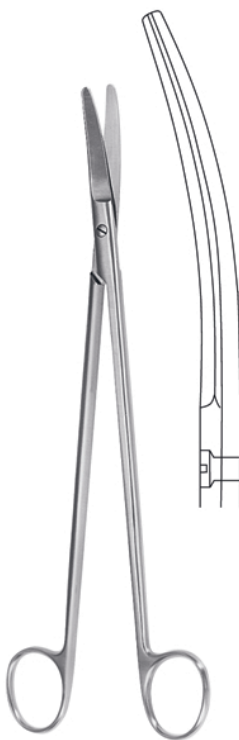

**WILLAUER**  
 25,0 cm, 9<sup>3</sup>/<sub>4</sub>" **KI-1011-354**  
 28,0 cm, 11" **KI-1011-355**



**POTTS-SMITH**  
 19,0 cm, 7<sup>1</sup>/<sub>2</sub>"  
**KI-1011-356**



**FINOCHIETTO**  
 32,5 cm, 10<sup>5</sup>/<sub>8</sub>"  
**KI-1011-357**

Lungenscheren, Dammscheren, Nabelschnurscheren  
Lobectomy Scissors, Episiotomy Scissors, Umbilical Cord Scissors  
Tijeras para lobectomía, Tijeras para episiotomía, Tijeras umbilicales  
Forbici per lobo, Forbici per episiotomia, Forbici ombelicali



**WALDMANN**  
18,0 cm, 7"  
**KI-1011-358**



**BRAUN-STADLER**  
14,5 cm, 5<sup>3</sup>/<sub>4</sub>"    **KI-1011-359**  
20,0 cm, 8"        **KI-1011-360**



**EPISIOTOMIE SCHERE**  
20,0 cm, 8"  
**KI-1011-361**



**MOD. USA**  
10,5 cm, 4<sup>1</sup>/<sub>8</sub>"  
**KI-1011-362**



**BUSCH**  
13,5 cm, 5<sup>3</sup>/<sub>8</sub>"    **KI-1011-363**  
16,0 cm, 6<sup>1</sup>/<sub>4</sub>"    **KI-1011-364**



**SCHUMACHER**  
16,0 cm, 16<sup>1</sup>/<sub>4</sub>"  
**KI-1011-365**

# General Surgery Instruments



"Supporting Healthcare"  
**KAAHA INDUSTRIES**  
 Manufacturer Of Dental & Surgical Instruments

Drahtscheren, Verband- und Kleiderstoffscheren  
 Wire Scissors, Bandage and Cloth Scissors  
 Cizallas corta-alambres, Tijeras para vendajes y tela  
 Forbici taglia cavo, Forbici per bendaggi e vestiti



gezahnt  
 serrated  
 dentada  
 dentata

**UNIVERSAL**  
 12,0 cm, 4<sup>3</sup>/<sub>4</sub>"  
**KI-1011-366**



**LISTER**

- |  |                    |
|--|--------------------|
| 9,0 cm, 3 <sup>1</sup> / <sub>2</sub> "  | <b>KI-1011-367</b> |
| 11,0 cm, 4 <sup>3</sup> / <sub>8</sub> " | <b>KI-1011-368</b> |
| 14,0 cm, 5 <sup>1</sup> / <sub>2</sub> " | <b>KI-1011-369</b> |
| 18,0 cm, 7"                              | <b>KI-1011-370</b> |
| 20,0 cm, 8"                              | <b>KI-1011-371</b> |



**LISTER**

- |  |                    |
|--|--------------------|
| 18,5 cm, 7 <sup>1</sup> / <sub>4</sub> " | <b>KI-1011-372</b> |
| 21,0 cm, 8 <sup>1</sup> / <sub>4</sub> " | <b>KI-1011-373</b> |



**LISTER-EXCENTRIC**

- |  |                    |
|--|--------------------|
| 16,0 cm, 6 <sup>1</sup> / <sub>4</sub> " | <b>KI-1011-374</b> |
| 19,0 cm, 7 <sup>1</sup> / <sub>2</sub> " | <b>KI-1011-375</b> |



gezahnt  
 serrated  
 dentada  
 dentata



**BERGMANN**

- |             |                    |
|-------------|--------------------|
| 23,0 cm, 9" | <b>KI-1011-376</b> |
|-------------|--------------------|

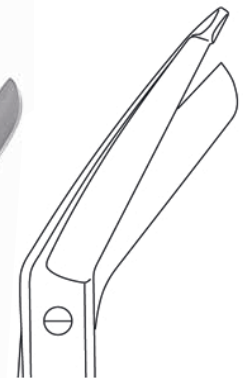

Verband- und Kleiderstoffscheren, Gipsscheren  
 Bandage and Cloth Scissors, Plaster-of-Paris Shears  
 Tijeras para vendajes y tela, Cizallas para escayolas  
 Forbici per bendaggi e vestiti, Cesoi per gessi



**ESMARCH**  
 20,0 cm, 8" **KI-1011-377**  
 22,0 cm, 8<sup>5</sup>/<sub>8</sub>" **KI-1011-378**

**KNOWLES**  
 14,0 cm, 5<sup>1</sup>/<sub>2</sub>"  
**KI-1011-379**

**BRUNS**  
 24,0 cm, 9<sup>1</sup>/<sub>2</sub>"  
**KI-1011-380**  
**KI-1011-381**

**LORENZ**  
 23,0 cm, 9"  
**KI-1011-382**

bis 134°C autoklavierbar  
 autoclavable up to 134°C  
 esterilizable en autoclave hasta 134°C  
 Sterilizzabile in autoclave fino 134°C

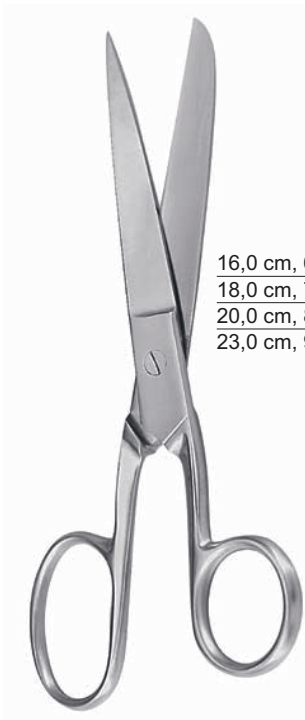

**SMITH**  
 (MOD. USA)

16,0 cm, 6<sup>1</sup>/<sub>4</sub>" **KI-1011-383**  
 18,0 cm, 7" **KI-1011-384**  
 20,0 cm, 8" **KI-1011-385**  
 23,0 cm, 9" **KI-1011-386**



**GIPSSCHERE**  
 20,0 cm, 8"  
**KI-1011-387**

gezahnt  
 serrated  
 dentada  
 dentata



**UNIVERSAL**  
 14,0 cm, 5<sup>1</sup>/<sub>2</sub>" **KI-1011-388**  
 16,0 cm, 6<sup>1</sup>/<sub>4</sub>" **KI-1011-389**  
 18,0 cm, 7" **KI-1011-390**

gezahnt  
 serrated  
 dentada  
 dentata

# General Surgery Instruments



"Supporting Healthcare"  
**KAHA INDUSTRIES**  
 Manufacturer Of Dental & Surgical Instruments

Chirurgische Scheren mit Hartmetallschneiden  
 Surgical Scissors with tungsten carbide edges  
 Tijeras para cirugía con filos de carburo tungsteno  
 Forbici per chirurgia con lame in carburo di tungsteno



**STANDARD**  
 14,5 cm, 5<sup>3</sup>/<sub>4</sub>" **KI-1011-391**  
 16,5 cm, 6<sup>1</sup>/<sub>2</sub>" **KI-1011-392**  
 18,5 cm, 7<sup>1</sup>/<sub>4</sub>" **KI-1011-393**



**STANDARD**  
 14,5 cm, 5<sup>3</sup>/<sub>4</sub>" **KI-1011-394**  
 16,5 cm, 6<sup>1</sup>/<sub>2</sub>" **KI-1011-395**  
 18,5 cm, 7<sup>1</sup>/<sub>4</sub>" **KI-1011-396**



**STANDARD**  
 14,5 cm, 5<sup>3</sup>/<sub>4</sub>" **KI-1011-397**  
 16,5 cm, 6<sup>1</sup>/<sub>2</sub>" **KI-1011-398**  
 18,5 cm, 7<sup>1</sup>/<sub>4</sub>" **KI-1011-399**



**STANDARD**  
 14,5 cm, 5<sup>3</sup>/<sub>4</sub>" **KI-1011-400**  
 16,5 cm, 6<sup>1</sup>/<sub>2</sub>" **KI-1011-401**  
 18,5 cm, 7<sup>1</sup>/<sub>4</sub>" **KI-1011-402**



**STANDARD**  
 14,5 cm, 5<sup>3</sup>/<sub>4</sub>" **KI-1011-403**  
 16,5 cm, 6<sup>1</sup>/<sub>2</sub>" **KI-1011-404**  
 18,5 cm, 7<sup>1</sup>/<sub>4</sub>" **KI-1011-405**



**STANDARD**  
 14,5 cm, 5<sup>3</sup>/<sub>4</sub>" **KI-1011-406**  
 16,5 cm, 6<sup>1</sup>/<sub>2</sub>" **KI-1011-407**  
 18,5 cm, 7<sup>1</sup>/<sub>4</sub>" **KI-1011-408**



Chirurgische Scheren mit Hartmetallschneiden  
 Surgical Scissors with tungsten carbide edges  
 Tijeras para cirugía con filos de carburo tungsteno  
 Forbici per chirurgia con lame in carburo di tungsteno



**MAYO**

14,5 cm, 5 <sup>3</sup> / <sub>4</sub> "	<b>KI-1011-409</b>
17,0 cm, 6 <sup>3</sup> / <sub>4</sub> "	<b>KI-1011-410</b>
23,0 cm, 9"	<b>KI-1011-411</b>



**MAYO**

14,5 cm, 5 <sup>3</sup> / <sub>4</sub> "	<b>KI-1011-412</b>
17,0 cm, 6 <sup>3</sup> / <sub>4</sub> "	<b>KI-1011-413</b>
23,0 cm, 9"	<b>KI-1011-414</b>



**MAYO-STILLE**

15,0 cm, 6"	<b>KI-1011-415</b>
17,0 cm, 6 <sup>3</sup> / <sub>4</sub> "	<b>KI-1011-416</b>



**MAYO-STILLE**

15,0 cm, 6"	<b>KI-1011-417</b>
17,0 cm, 6 <sup>3</sup> / <sub>4</sub> "	<b>KI-1011-418</b>



**LEXER**

16,0 cm, 6 <sup>1</sup> / <sub>4</sub> "	<b>KI-1011-419</b>
21,0 cm, 8 <sup>1</sup> / <sub>4</sub> "	<b>KI-1011-420</b>



**LEXER**

16,0 cm, 6 <sup>1</sup> / <sub>4</sub> "	<b>KI-1011-421</b>
21,0 cm, 8 <sup>1</sup> / <sub>4</sub> "	<b>KI-1011-422</b>

# General Surgery Instruments



"Supporting Healthcare"  
**KAHA INDUSTRIES**  
 Manufacturer Of Dental & Surgical Instruments

Präparierscheren mit Hartmetallschneiden  
 Dissecting Scissors with tungsten carbide edges  
 Tijeras para disección con filos de carburo tungsteno  
 Forbici per dissezione con lame in carburo di tungsteno

**KI-1011-423**  
**BABY-METZENBAUM**  
 11,5 cm, 4 1/2"

**KI-1011-424**  
**METZENBAUM**  
 14,5 cm, 5 3/4"

**KI-1011-425** **KI-1011-426**

**KI-1011-427** **KI-1011-428**

**KI-1011-429** **KI-1011-430**

**KI-1011-431** 18,0 cm, 7"  
**KI-1011-432** 20,0 cm, 8"  
**KI-1011-433** 23,0 cm, 9"  
**KI-1011-434** 25,0 cm, 10"  
**KI-1011-435** 28,0 cm, 11"  
**KI-1011-436** 30,0 cm, 12"

**KI-1011-437** 18,0 cm, 7"  
**KI-1011-438** 20,0 cm, 8"  
**KI-1011-439** 23,0 cm, 9"  
**KI-1011-440** 25,0 cm, 10"  
**KI-1011-441** 28,0 cm, 11"  
**KI-1011-442** 30,0 cm, 12"

**METZENBAUM**  
 14,5 cm, 5 3/4"

**METZENBAUM**

**METZENBAUM**

# General Surgery Instruments



"Supporting Healthcare"  
**KAHA INDUSTRIES**  
 Manufacturer Of Dental & Surgical Instruments



18,0 cm, 7" **KI-1011-443**  
 20,0 cm, 8" **KI-1011-444**  
 23,0 cm, 9" **KI-1011-445**  
 25,0 cm, 10" **KI-1011-446**  
 28,0 cm, 11" **KI-1011-447**  
 30,0 cm, 12" **KI-1011-448**

**METZENBAUM**

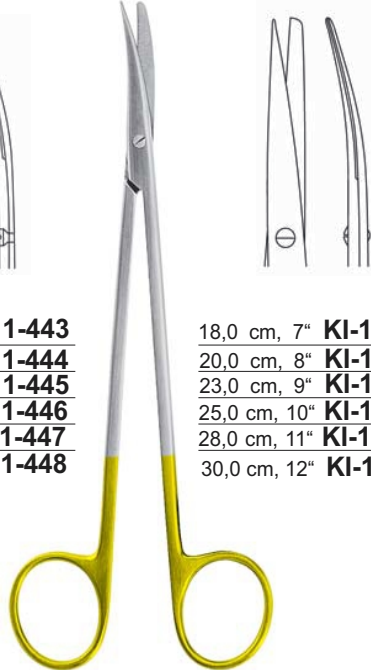

18,0 cm, 7" **KI-1011-449**  
 20,0 cm, 8" **KI-1011-450**  
 23,0 cm, 9" **KI-1011-452**  
 25,0 cm, 10" **KI-1011-453**  
 28,0 cm, 11" **KI-1011-454**  
 30,0 cm, 12" **KI-1011-455**

**METZENBAUM**

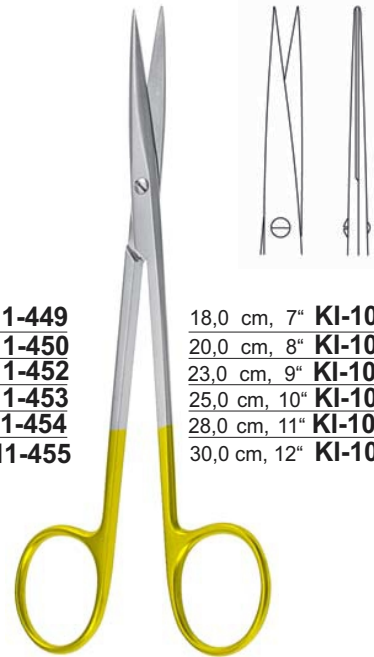

18,0 cm, 7" **KI-1011-456**  
 20,0 cm, 8" **KI-1011-457**  
 23,0 cm, 9" **KI-1011-458**  
 25,0 cm, 10" **KI-1011-459**  
 28,0 cm, 11" **KI-1011-460**  
 30,0 cm, 12" **KI-1011-461**

**METZENBAUM**



18,0 cm, 7" **KI-1011-462**  
 20,0 cm, 8" **KI-1011-463**  
 23,0 cm, 9" **KI-1011-464**  
 25,0 cm, 10" **KI-1011-465**  
 28,0 cm, 11" **KI-1011-466**  
 30,0 cm, 12" **KI-1011-467**

**METZENBAUM**

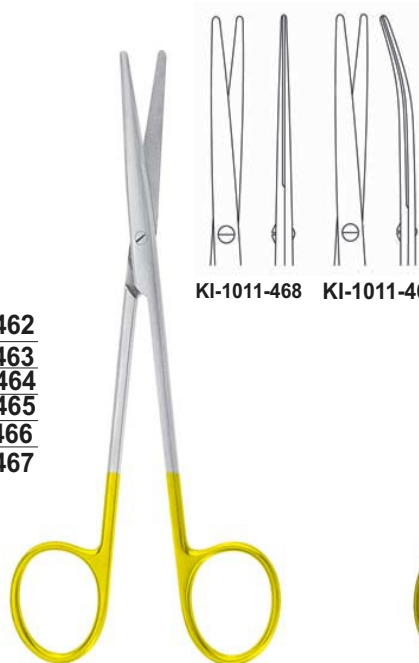

**KI-1011-468** **KI-1011-469**

**METZENBAUM-FINO**

14,5 cm, 5<sup>3</sup>/<sub>4</sub>"

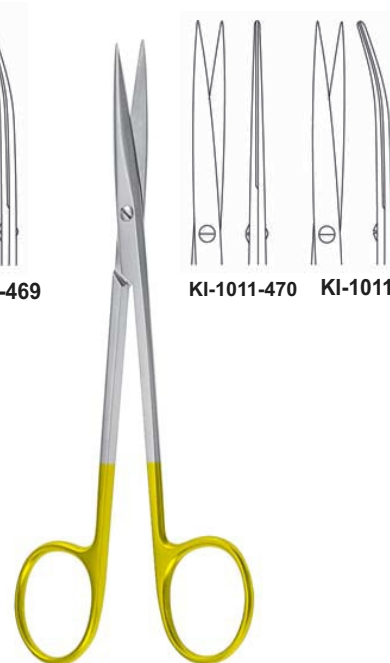

**KI-1011-470** **KI-1011-471**

**METZENBAUM-FINO**

14,5 cm, 5<sup>3</sup>/<sub>4</sub>"

Präparierscheren mit Hartmetallschneiden  
 Dissecting Scissors with tungsten carbide edges  
 Tijeras para disección con filos de carburo tungsteno  
 Forbici per dissezione con lame in carburo di tungsteno

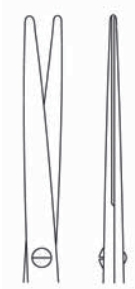
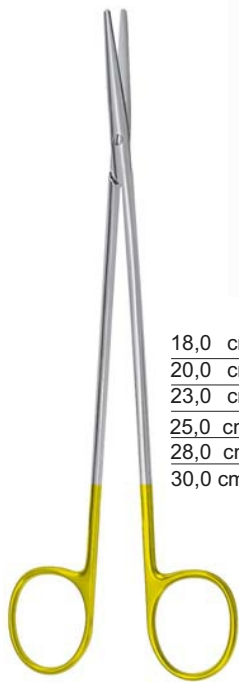

18,0 cm, 7" **KI-1011-472**  
 20,0 cm, 8" **KI-1011-473**  
 23,0 cm, 9" **KI-1011-474**  
 25,0 cm, 10" **KI-1011-475**  
 28,0 cm, 11" **KI-1011-476**  
 30,0 cm, 12" **KI-1011-477**

**METZENBAUM-FINO**

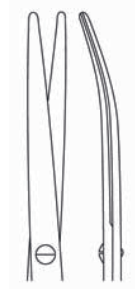
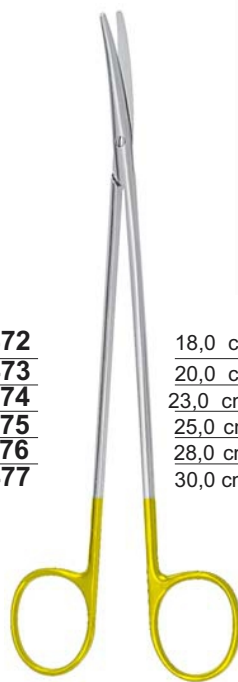

18,0 cm, 7" **KI-1011-478**  
 20,0 cm, 8" **KI-1011-479**  
 23,0 cm, 9" **KI-1011-480**  
 25,0 cm, 10" **KI-1011-481**  
 28,0 cm, 11" **KI-1011-482**  
 30,0 cm, 12" **KI-1011-483**

**METZENBAUM-FINO**

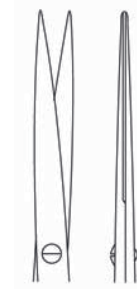

18,0 cm, 7" **KI-1011-484**  
 20,0 cm, 8" **KI-1011-485**  
 23,0 cm, 9" **KI-1011-486**  
 25,0 cm, 10" **KI-1011-487**  
 28,0 cm, 11" **KI-1011-488**  
 30,0 cm, 12" **KI-1011-489**

**METZENBAUM-FINO**



18,0 cm, 7" **KI-1011-490**  
 20,0 cm, 8" **KI-1011-491**  
 23,0 cm, 9" **KI-1011-492**  
 25,0 cm, 10" **KI-1011-493**  
 28,0 cm, 11" **KI-1011-494**  
 30,0 cm, 12" **KI-1011-495**

**METZENBAUM-FINO**



**METZENBAUM-LAHEY**  
 14,0 cm, 5 1/2"  
**KI-1011-496**

**METZENBAUM-LAHEY**



**TOENNIS-ADSON**  
 17,0 cm, 6 3/4"  
**KI-1011-497**

**TOENNIS-ADSON**

Präparierscheren mit Hartmetallschneiden  
 Dissecting Scissors with tungsten carbide edges  
 Tijeras para disección con filos de carburo tungsteno  
 Forbici per dissezione con lame in carburo di tungsteno



**METZENBAUM-FINO S**

18,0 cm, 7" **KI-1011-498**  
 20,0 cm, 8" **KI-1011-499**  
 23,0 cm, 9" **KI-1011-500**



**METZENBAUM-FINO S**

18,0 cm, 7" **KI-1011-501**  
 20,0 cm, 8" **KI-1011-502**  
 23,0 cm, 9" **KI-1011-503**



**REYNOLDS**  
 15,0 cm, 6"  
**KI-1011-504**



**REYNOLDS**  
 15,0 cm, 6"  
**KI-1011-505**



**HYSTEREKTOMY**  
 25,5 cm, 10"  
**KI-1011-506**



**HYSTEREKTOM**  
 Y 25,0 cm, 9<sup>3</sup>/<sub>4</sub>"  
**KI-1011-507**

Gynäkologische Scheren mit Hartmetallschneiden  
 Gynecology Scissors with tungsten carbide edges  
 Tijeras para ginecología con filos de carburo tungsteno  
 Forbici per ginecologia con lame in carburo di tungsteno



SIMS

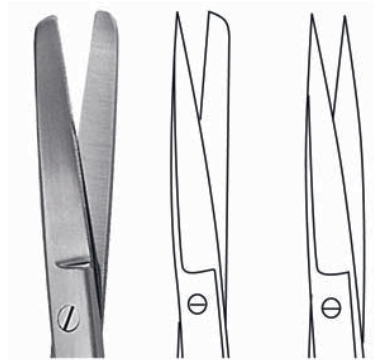

20,0 cm, 8" **KI-1011-508** **KI-1011-510** **KI-1011-512**  
 23,0 cm, 9" **KI-1011-509** **KI-1011-511** **KI-1011-513**



SIMS



20,0 cm, 8" **KI-1011-514** **KI-1011-516** **KI-1011-518**  
 23,0 cm, 9" **KI-1011-515** **KI-1011-517** **KI-1011-519**

Gefäßscheren mit Hartmetallschneiden  
 Vascular Scissors with tungsten carbide edges  
 Tijeras vasculares con filos de carburo tungsteno  
 Forbici vascolari con lame in carburo di tungsteno



**DIETRICH**  
 17,5 cm, 6<sup>5</sup>/<sub>8</sub>"  
**KI-1011-520**



**POTTS DE MARTEL**  
 24,0 cm, 9<sup>1</sup>/<sub>2</sub>"  
**KI-1011-521**



**DE BAKEY**

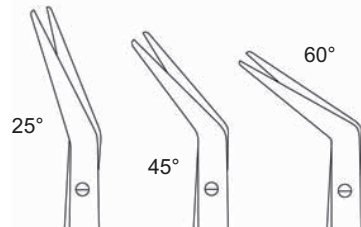

20,0 cm, 8" **KI-1011-522** **KI-1011-524** **KI-1011-526**  
 23,0 cm, 9" **KI-1011-523** **KI-1011-525** **KI-1011-527**

Gefäßscheren mit Hartmetallschneiden  
Vascular Scissors with tungsten carbide edges  
Tijeras vasculares con filos de carburo tungsteno  
Forbici vascolari con lame in carburo di tungsteno



**DIETRICH-HEGEMANN**  
18,0 cm, 7"

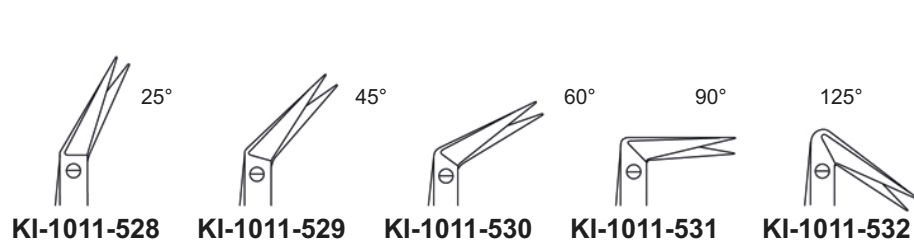

**POTTS-SMITH**  
18,0 cm, 7 1/2"

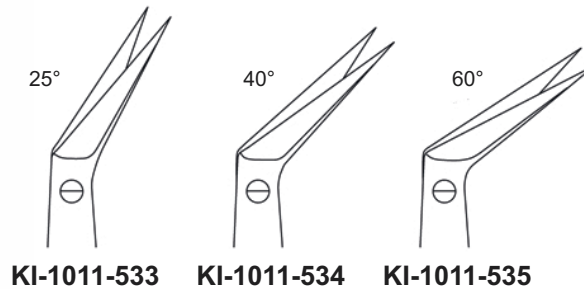



Scheren mit Hartmetallschneiden  
Scissors with tungsten carbide edges  
Tijeras con filos de carburo tungsteno  
Forbici con lame in carburo di tungsteno



**IRIS**  
11,5 cm, 4½"

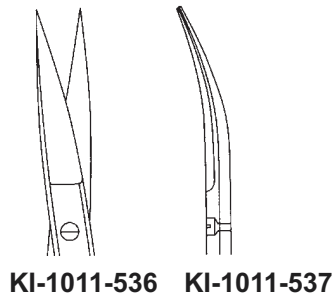

**UNIVERSAL**  
12,0 cm, 4¾"  
KI-1011-538

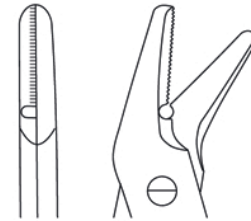

gezahnt  
serrated  
dentada  
dentata



**LISTER**  
18,0 cm, 7"  
KI-1011-539

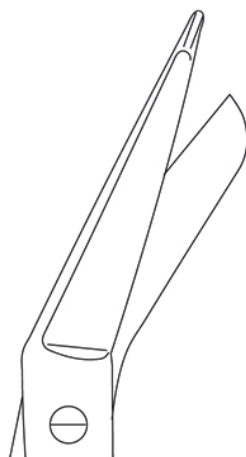

**BRUNS**  
24,0 cm, 9½"  
KI-1011-540



# General Surgery Instruments



"Supporting Healthcare"  
**KAHA INDUSTRIES**  
 Manufacturer Of Dental & Surgical Instruments

Super-Cut Scheren  
 Super-Cut Scissors  
 Tijeras Super-Cut  
 Forbici Super-Cut



**MAYO**  
 17,0 cm, 6<sup>3</sup>/<sub>4</sub>"



**KI-1011-541**



**KI-1011-542**



**METZENBAUM**



14,5 cm, 5<sup>3</sup>/<sub>4</sub>" **KI-1011-543**  
 18,0 cm, 7" **KI-1011-544**  
 20,0 cm, 8" **KI-1011-545**  
 23,0 cm, 9" **KI-1011-546**

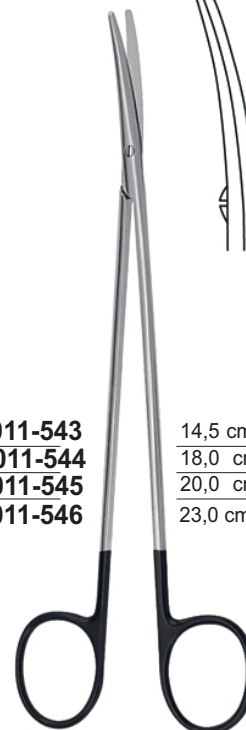

**METZENBAUM-FINO**



14,5 cm, 5<sup>3</sup>/<sub>4</sub>" **KI-1011-547**  
 18,0 cm, 7" **KI-1011-548**  
 20,0 cm, 8" **KI-1011-549**  
 23,0 cm, 9" **KI-1011-550**



**KAYE FACE LIFT**



15,0 cm, 6" **KI-1011-551**  
 19,0 cm, 7<sup>1</sup>/<sub>2</sub>" **KI-1011-552**



**JABALEY**  
 13,0 cm, 5"  
**KI-1011-553**



**ENDARTERECTOMY**  
 18,0 cm, 7"  
**KI-1011-554**



**TOENNIS-ADSON**  
 17,0 cm, 6<sup>3</sup>/<sub>4</sub>"  
**KI-1011-555**

Super-Cut Scheren  
 Super-Cut Scissors  
 Tijeras Super-Cut  
 Forbici Super-Cut



KI-1011-556

**STRABISMUS**  
 11,5 cm, 4 1/2"



KI-1011-557

**JAMISON**  
 15,0 cm, 6" **KI-1011-558**  
 18,0 cm, 7" **KI-1011-559**



**REYNOLDS**  
 12,5 cm, 5"  
**KI-1011-560**



**BABY-METZENBAUM**  
 11,0 cm, 4 3/8" **KI-1011-561**  
 14,5 cm, 5 3/4" **KI-1011-562**



**IRIS**  
 11,0 cm, 4 3/8"  
**KI-1011-563**



**IRIS**  
 11,0 cm, 4 3/8"  
**KI-1011-564**



**STEVENS TENOTOMY**  
 11,0 cm, 4 3/8"  
**KI-1011-565**



**STEVENS TENOTOMY**  
 11,0 cm, 4 3/8"  
**KI-1011-566**

# General Surgery Instruments



"Supporting Healthcare"  
**KAHA INDUSTRIES**  
 Manufacturer Of Dental & Surgical Instruments

Super-Cut Scheren  
 Super-Cut Scissors  
 Tijeras Super-Cut  
 Forbici Super-Cut



**PAR TYPE**  
 12,0 cm, 4<sup>3</sup>/<sub>4</sub>"  
**KI-1011-567**



**PAR TYPE**  
 12,0 cm, 4<sup>3</sup>/<sub>4</sub>"  
**KI-1011-568**



**POTTS**  
 19,0 cm, 7<sup>1</sup>/<sub>2</sub>"



**KI-1011-569**

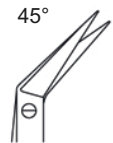

**KI-1011-570**

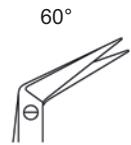

**KI-1011-571**

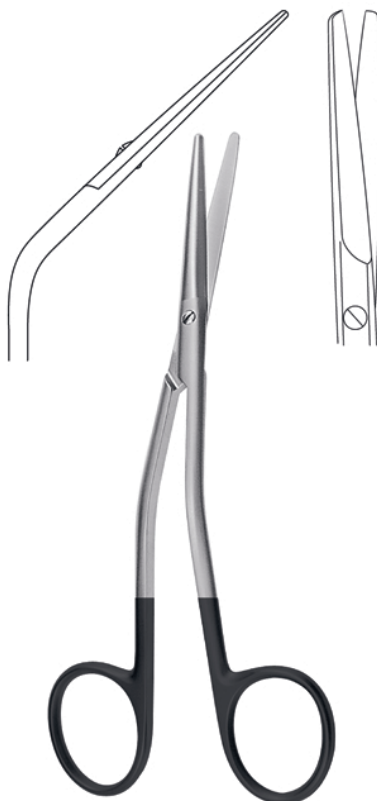

**FOMON**  
 14,5 cm, 5<sup>3</sup>/<sub>4</sub>"  
**KI-1011-572**



**COTTLE**  
 16,5 cm, 6<sup>1</sup>/<sub>2</sub>"  
**KI-1011-573**

# General Surgery Instruments



"Supporting Healthcare"  
**KAHA INDUSTRIES**  
 Manufacturer Of Dental & Surgical Instruments

**Mikro-Scheren**  
**Micro Scissors**  
**Micro-Tijeras**  
**Micro-Forbici**

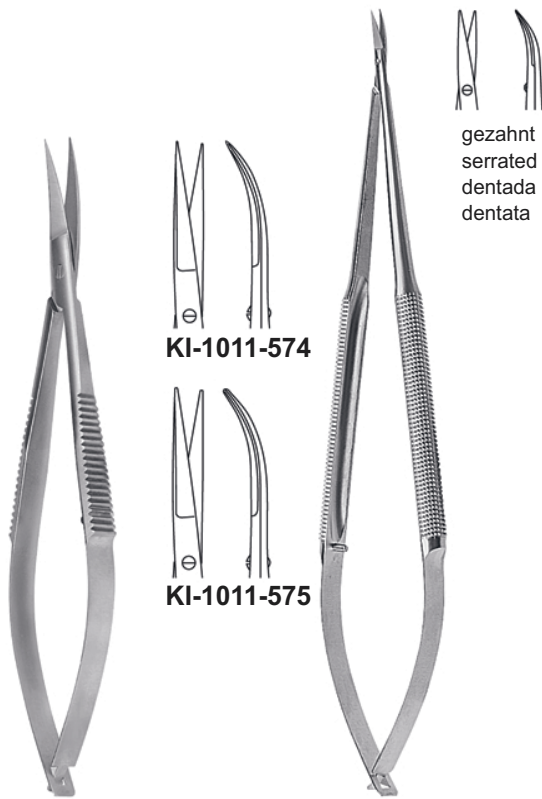

gezahnt  
 serrated  
 dentada  
 dentata

**KI-1011-574**

**KI-1011-575**



Mikro-Präparierscheren  
 Micro-dissecting scissors  
 Micro-tijeras de disección  
 Micro-forbici per dissezione

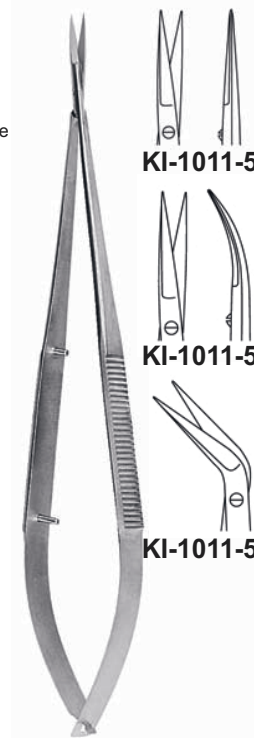

**KI-1011-528**

**KI-1011-528**

**KI-1011-528**

**WESTCOTT**  
 11,0 cm, 4<sup>3</sup>/<sub>8</sub>"

<b>GOMEL</b>	<b>HEPP SCHEIDEL</b>
14,0 cm, 5 <sup>1</sup> / <sub>2</sub> " <b>KI-1011-576</b>	14,0 cm, 5 <sup>1</sup> / <sub>2</sub> " <b>KI-1011-578</b>
16,0 cm, 6 <sup>1</sup> / <sub>4</sub> " <b>KI-1011-577</b>	16,0 cm, 6 <sup>1</sup> / <sub>4</sub> " <b>KI-1011-579</b>

18,5 cm, 7<sup>1</sup>/<sub>4</sub>"



**SIMS**



18,5 cm, 7 <sup>1</sup> / <sub>4</sub> " <b>KI-1011-580</b>	<b>KI-1011-582</b>	<b>KI-1011-584</b>	<b>KI-1011-586</b>
22,5 cm, 8 <sup>3</sup> / <sub>4</sub> " <b>KI-1011-581</b>	<b>KI-1011-583</b>	<b>KI-1011-585</b>	<b>KI-1011-587</b>

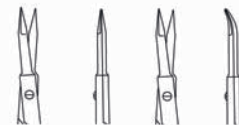

18,5 cm, 7 <sup>1</sup> / <sub>4</sub> " <b>KI-1011-588</b>	<b>KI-1011-590</b>
22,5 cm, 8 <sup>3</sup> / <sub>4</sub> " <b>KI-1011-589</b>	<b>KI-1011-591</b>

Mikro-Scheren, Mikro-Disektionsscheren  
 Micro Scissors, Micro Dissecting Scissors  
 Micro-Tijeras, Micro-Tijeras de disección  
 Micro-Forbici, Micro-Forbici per dissezione



18,0 cm, 7"



KI-1011-592

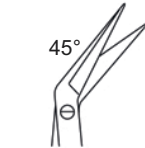

KI-1011-593

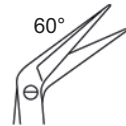

KI-1011-594

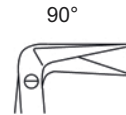

KI-1011-595



KI-1011-596



KI-1011-597

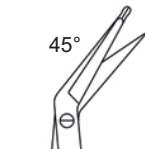

KI-1011-598

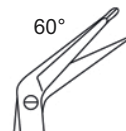

KI-1011-599

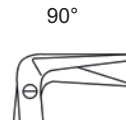

KI-1011-600



KI-1011-601



15,0 cm, 6"  
**KI-1011-602**



15,0 cm, 6"  
**KI-1011-603**



gezahnt  
 serrated  
 dentada  
 dentata



15,0 cm, 6"  
**KI-1011-604**



18,0 cm, 7"  
**KI-1011-605**

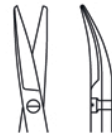

**Mikro-Adventitiascheren**  
**Micro Adventitia Scissors**  
**Micro-Tijeras Adventitia**  
**Micro-Forbici Adventitia**



15,0 cm, 6"  
**KI-1011-606**



15,0 cm, 6"  
**KI-1011-607**



gezahnt  
serrated  
dentada  
dentata



15,0 cm, 6"  
**KI-1011-608**



18,0 cm, 7"  
**KI-1011-609**





"Supporting Healthcare"

**KAAHA INDUSTRIES**

Manufacturer Of Dental & Surgical Instruments

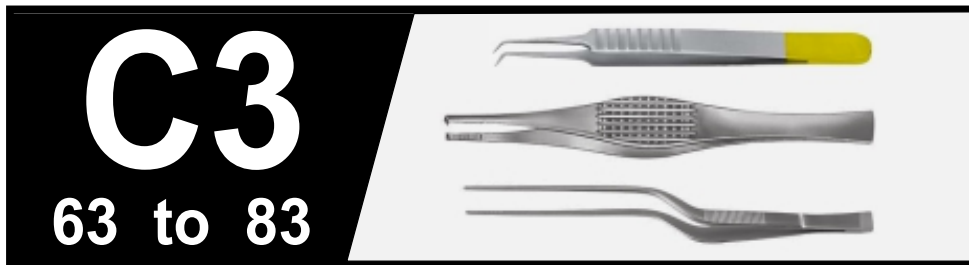

**Pinzetten**

**Forceps**

**Pinzas**

**Pinze**



Anatomische Pinzetten  
 Dissecting Forceps  
 Pinzas de disección  
 Pinze anatomiche per dissezione



**STANDARD**

10,5 cm, 4 <sup>1</sup> / <sub>8</sub> "	<b>KI-1021-01</b>
11,5 cm, 4 <sup>1</sup> / <sub>2</sub> "	<b>KI-1021-02</b>
13,0 cm, 5"	<b>KI-1021-03</b>
14,5 cm, 5 <sup>3</sup> / <sub>4</sub> "	<b>KI-1021-04</b>
15,0 cm, 6"	<b>KI-1021-05</b>
16,0 cm, 6 <sup>1</sup> / <sub>4</sub> "	<b>KI-1021-06</b>
18,0 cm, 7"	<b>KI-1021-07</b>
20,0 cm, 8"	<b>KI-1021-08</b>
25,0 cm, 10"	<b>KI-1021-10</b>
30,0 cm, 12"	<b>KI-1021-11</b>



schmal  
 narrow  
 estrechos  
 stretti

**STANDARD**

10,5 cm, 4 <sup>1</sup> / <sub>8</sub> "	<b>KI-1021-11</b>
11,5 cm, 4 <sup>1</sup> / <sub>2</sub> "	<b>KI-1021-12</b>
13,0 cm, 5"	<b>KI-1021-13</b>
14,5 cm, 5 <sup>3</sup> / <sub>4</sub> "	<b>KI-1021-14</b>
15,0 cm, 6"	<b>KI-1021-15</b>
16,0 cm, 6 <sup>1</sup> / <sub>4</sub> "	<b>KI-1021-16</b>
18,0 cm, 7"	<b>KI-1021-17</b>
20,0 cm, 8"	<b>KI-1021-18</b>
25,0 cm, 10"	<b>KI-1021-19</b>
30,0 cm, 12"	<b>KI-1021-20</b>



schmal  
 narrow  
 estrechos  
 stretti

**STANDARD**

10,5 cm, 4 <sup>1</sup> / <sub>8</sub> "	<b>KI-1021-21</b>
11,5 cm, 4 <sup>1</sup> / <sub>2</sub> "	<b>KI-1021-22</b>
13,0 cm, 5"	<b>KI-1021-23</b>
14,5 cm, 5 <sup>3</sup> / <sub>4</sub> "	<b>KI-1021-24</b>
15,0 cm, 6"	<b>KI-1021-25</b>
16,0 cm, 6 <sup>1</sup> / <sub>4</sub> "	<b>KI-1021-26</b>
18,0 cm, 7"	<b>KI-1021-27</b>
20,0 cm, 8"	<b>KI-1021-28</b>
25,0 cm, 10"	<b>KI-1021-29</b>
30,0 cm, 12"	<b>KI-1021-30</b>



fein  
 fine  
 finas  
 fini

**STANDARD**

10,5 cm, 4 <sup>1</sup> / <sub>8</sub> "	<b>KI-1021-31</b>
11,5 cm, 4 <sup>1</sup> / <sub>2</sub> "	<b>KI-1021-32</b>
13,0 cm, 5"	<b>KI-1021-33</b>
14,5 cm, 5 <sup>3</sup> / <sub>4</sub> "	<b>KI-1021-34</b>
15,0 cm, 6"	<b>KI-1021-35</b>
16,0 cm, 6 <sup>1</sup> / <sub>4</sub> "	<b>KI-1021-36</b>
18,0 cm, 7"	<b>KI-1021-37</b>
20,0 cm, 8"	<b>KI-1021-38</b>
25,0 cm, 10"	<b>KI-1021-39</b>
30,0 cm, 12"	<b>KI-1021-40</b>

Anatomische Pinzetten  
 Dissecting Forceps  
 Pinzas de disección  
 Pinze anatomiche per dissezione



fein  
 fine  
 finas  
 fini



fein  
 fine  
 finas  
 fini

mit Stift  
 with pin  
 con perno  
 con espiga



schmal  
 narrow  
 estrechos  
 stretti

10,5 cm, 4 <sup>1</sup> / <sub>8</sub> "	<b>KI-1021-41</b>
11,5 cm, 4 <sup>1</sup> / <sub>2</sub> "	<b>KI-1021-42</b>
13,0 cm, 5"	<b>KI-1021-43</b>
14,5 cm, 5 <sup>3</sup> / <sub>4</sub> "	<b>KI-1021-44</b>
16,0 cm, 6 <sup>1</sup> / <sub>4</sub> "	<b>KI-1021-45</b>
18,0 cm, 7"	<b>KI-1021-46</b>
20,0 cm, 8"	<b>KI-1021-47</b>
25,0 cm, 10"	<b>KI-1021-48</b>
30,0 cm, 12"	<b>KI-1021-49</b>

10,5 cm, 4 <sup>1</sup> / <sub>8</sub> "	<b>KI-1021-50</b>
11,5 cm, 4 <sup>1</sup> / <sub>2</sub> "	<b>KI-1021-51</b>
13,0 cm, 5"	<b>KI-1021-52</b>
14,5 cm, 5 <sup>3</sup> / <sub>4</sub> "	<b>KI-1021-53</b>
16,0 cm, 6 <sup>1</sup> / <sub>4</sub> "	<b>KI-1021-54</b>
18,0 cm, 7"	<b>KI-1021-55</b>
20,0 cm, 8"	<b>KI-1021-56</b>
25,0 cm, 10"	<b>KI-1021-57</b>
30,0 cm, 12"	<b>KI-1021-58</b>

MOD. USA	
12,0 cm, 4 <sup>3</sup> / <sub>4</sub> "	<b>KI-1021-59</b>
13,0 cm, 5"	<b>KI-1021-60</b>
14,5 cm, 5 <sup>3</sup> / <sub>4</sub> "	<b>KI-1021-61</b>
15,0 cm, 6"	<b>KI-1021-62</b>
18,0 cm, 7"	<b>KI-1021-63</b>
20,0 cm, 8"	<b>KI-1021-64</b>
25,5 cm, 10"	<b>KI-1021-65</b>
30,0 cm, 12"	<b>KI-1021-66</b>

MOD. USA	
12,0 cm, 4 <sup>3</sup> / <sub>4</sub> "	<b>KI-1021-67</b>
13,0 cm, 5"	<b>KI-1021-68</b>
14,5 cm, 5 <sup>3</sup> / <sub>4</sub> "	<b>KI-1021-69</b>
15,0 cm, 6"	<b>KI-1021-70</b>
18,0 cm, 7"	<b>KI-1021-71</b>
20,0 cm, 8"	<b>KI-1021-72</b>
25,5 cm, 10"	<b>KI-1021-73</b>

Anatomische Pinzetten  
 Dissecting Forceps  
 Pinzas de disección  
 Pinze anatomiche per dissezione



**ADSON**  
 12,0 cm, 4<sup>3</sup>/<sub>4</sub>" **KI-1021-74**  
 15,0 cm, 6" **KI-1021-75**



**MICRO-ADSON**  
 12,0 cm, 4<sup>3</sup>/<sub>4</sub>" **KI-1021-76**  
 15,0 cm, 6" **KI-1021-77**



**STILLE**  
 15,0 cm, 6"  
**KI-1021-78**



**MC INDOE**  
 15,0 cm, 6"  
**KI-1021-79**



**TAYLOR**  
 17,5 cm, 6<sup>5</sup>/<sub>8</sub>"  
**KI-1021-80**



**TAYLOR**  
 17,5 cm, 6<sup>5</sup>/<sub>8</sub>"  
**KI-1021-81**



**TAYLOR**  
 18,5 cm, 7<sup>1</sup>/<sub>4</sub>"  
**KI-1021-82**



**GERALD**  
 18,0 cm, 7"  
**KI-1021-83**

Anatomische Pinzetten  
 Dissecting Forceps  
 Pinzas de disección  
 Pinze anatomiche per dissezione



**GERALD**  
 18,0 cm, 7"  
**KI-1021-84**



**POTTS-SMITH**  
 18,0 cm, 7" **KI-1021-85**  
 21,0 cm, 8 1/4" **KI-1021-86**  
 25,0 cm, 10" **KI-1021-87**



**POTTS-SMITH**  
 18,0 cm, 7" **KI-1021-88**  
 21,0 cm, 8 1/4" **KI-1021-89**  
 25,0 cm, 10" **KI-1021-90**



englische Modelle  
 english patterns  
 modelos ingleses  
 modelli inglese

13,0 cm, 5" **KI-1021-91**  
 14,5 cm, 5 3/4" **KI-1021-92**  
 15,0 cm, 6" **KI-1021-93**



**SEMKEN**  
 12,5 cm, 5" **KI-1021-94**  
 15,0 cm, 6" **KI-1021-95**



**CUSHING**  
 17,5 cm, 6 5/8"  
**KI-1021-96**



**CUSHING**  
 17,5 cm, 6 5/8"  
**KI-1021-97**



20,0 cm, 8"  
**KI-1021-98**

Anatomische Pinzetten  
 Dissecting Forceps  
 Pinzas de disección  
 Pinze anatomiche per dissezione



**BROPHY**  
 20,0 cm, 8"  
 KI-1021-99



**BONNEY**  
 18,0 cm, 7"  
 KI-1021-100



**SINGLE-TUTTLE**  
 23,0 cm, 9"  
 KI-1021-101



**DENNIS BROWN**  
 20,0 cm, 8"  
 KI-1021-102



**DUEHRSEN**  
 20,0 cm, 8"  
 KI-1021-103



**WAUGH**  
 15,0 cm, 6"    **KI-1021-104**  
 20,0 cm, 8"    **KI-1021-105**



**RAMSEY**  
 18,0 cm, 7"  
 KI-1021-106

Chirurgische Pinzetten  
 Tissue Forceps  
 Pinzas quirúrgicas  
 Pinze per chirurgia



STANDARD		
10,5 cm, 4 <sup>1</sup> / <sub>8</sub> "	<b>KI-1021-107</b>	
11,5 cm, 4 <sup>1</sup> / <sub>2</sub> "	<b>KI-1021-108</b>	
13,0 cm, 5"	<b>KI-1021-109</b>	
14,5 cm, 5 <sup>3</sup> / <sub>4</sub> "	<b>KI-1021-110</b>	
15,0 cm, 6"	<b>KI-1021-111</b>	
16,0 cm, 6 <sup>1</sup> / <sub>4</sub> "	<b>KI-1021-112</b>	
18,0 cm, 7"	<b>KI-1021-113</b>	
20,0 cm, 8"	<b>KI-1021-114</b>	
25,0 cm, 10"	<b>KI-1021-115</b>	
30,0 cm, 12"	<b>KI-1021-116</b>	

11,5 cm, 4 <sup>1</sup> / <sub>2</sub> "	<b>KI-1021-117</b>	
13,0 cm, 5"	<b>KI-1021-118</b>	
14,5 cm, 5 <sup>3</sup> / <sub>4</sub> "	<b>KI-1021-119</b>	
16,0 cm, 6 <sup>1</sup> / <sub>4</sub> "	<b>KI-1021-120</b>	
18,0 cm, 7"	<b>KI-1021-121</b>	
20,0 cm, 8"	<b>KI-1021-122</b>	
25,0 cm, 10"	<b>KI-1021-123</b>	
30,0 cm, 12"	<b>KI-1021-124</b>	

13,0 cm, 5"	<b>KI-1021-125</b>	
14,5 cm, 5 <sup>3</sup> / <sub>4</sub> "	<b>KI-1021-126</b>	
16,0 cm, 6 <sup>1</sup> / <sub>4</sub> "	<b>KI-1021-127</b>	
18,0 cm, 7"	<b>KI-1021-128</b>	
20,0 cm, 8"	<b>KI-1021-129</b>	

13,0 cm, 5"	<b>KI-1021-130</b>	
14,5 cm, 5 <sup>3</sup> / <sub>4</sub> "	<b>KI-1021-131</b>	
16,0 cm, 6 <sup>1</sup> / <sub>4</sub> "	<b>KI-1021-132</b>	
18,0 cm, 7"	<b>KI-1021-133</b>	
20,0 cm, 8"	<b>KI-1021-134</b>	

Chirurgische Pinzetten  
 Tissue Forceps  
 Pinzas quirúrgicas  
 Pinze per chirurgia

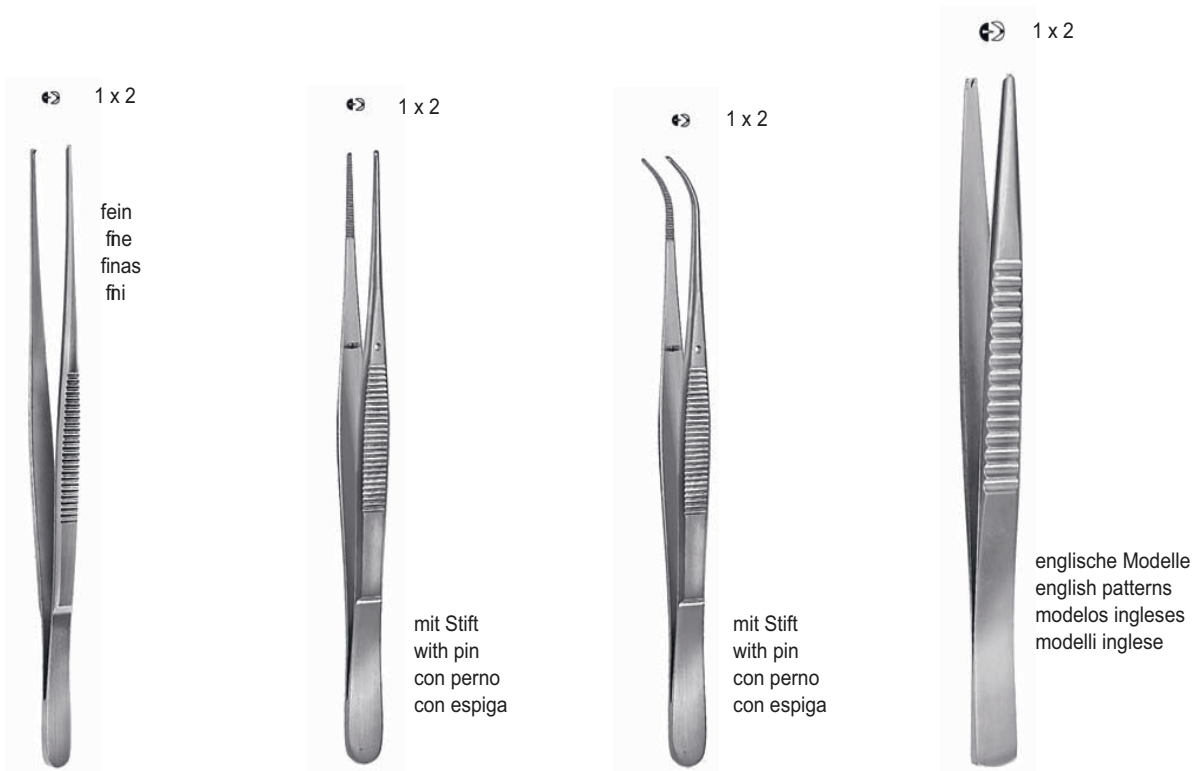

13,0 cm, 5"	<b>KI-1021-135</b>
14,5 cm, 5 <sup>3</sup> / <sub>4</sub> "	<b>KI-1021-136</b>
15,5 cm, 6"	<b>KI-1021-137</b>
16,0 cm, 6 <sup>1</sup> / <sub>4</sub> "	<b>KI-1021-138</b>
18,0 cm, 7"	<b>KI-1021-139</b>
20,0 cm, 8"	<b>KI-1021-140</b>
25,0 cm, 10"	<b>KI-1021-141</b>
30,0 cm, 12"	<b>KI-1021-142</b>

13,0 cm, 5"	<b>KI-1021-143</b>
14,5 cm, 5 <sup>3</sup> / <sub>4</sub> "	<b>KI-1021-144</b>
15,5 cm, 6"	<b>KI-1021-145</b>
16,0 cm, 6 <sup>1</sup> / <sub>4</sub> "	<b>KI-1021-146</b>
18,0 cm, 7"	<b>KI-1021-147</b>
20,0 cm, 8"	<b>KI-1021-148</b>
25,0 cm, 10"	<b>KI-1021-149</b>
30,0 cm, 12"	<b>KI-1021-150</b>

13,0 cm, 5"	<b>KI-1021-151</b>
14,5 cm, 5 <sup>3</sup> / <sub>4</sub> "	<b>KI-1021-152</b>
16,0 cm, 6 <sup>1</sup> / <sub>4</sub> "	<b>KI-1021-153</b>
18,0 cm, 7"	<b>KI-1021-154</b>
20,0 cm, 8"	<b>KI-1021-155</b>

13,0 cm, 5"	<b>KI-1021-156</b>
14,5 cm, 5 <sup>3</sup> / <sub>4</sub> "	<b>KI-1021-157</b>
15,0 cm, 6"	<b>KI-1021-158</b>

Chirurgische Pinzetten  
 Tissue Forceps  
 Pinzas quirúrgicas  
 Pinze per chirurgia



MOD. USA	
12,0 cm, 4 <sup>3</sup> / <sub>4</sub> "	<b>KI-1021-159</b>
13,0 cm, 5"	<b>KI-1021-160</b>
14,5 cm, 5 <sup>3</sup> / <sub>4</sub> "	<b>KI-1021-161</b>
15,5 cm, 6"	<b>KI-1021-162</b>
18,0 cm, 7"	<b>KI-1021-163</b>
20,0 cm, 8"	<b>KI-1021-164</b>
25,0 cm, 10"	<b>KI-1021-165</b>
30,0 cm, 12"	<b>KI-1021-166</b>



MOD. USA	
12,0 cm, 4 <sup>3</sup> / <sub>4</sub> "	<b>KI-1021-167</b>
13,0 cm, 5"	<b>KI-1021-168</b>
14,5 cm, 5 <sup>3</sup> / <sub>4</sub> "	<b>KI-1021-169</b>
15,5 cm, 6"	<b>KI-1021-170</b>
18,0 cm, 7"	<b>KI-1021-171</b>
20,0 cm, 8"	<b>KI-1021-172</b>
25,0 cm, 10"	<b>KI-1021-173</b>
30,0 cm, 12"	<b>KI-1021-174</b>



ADSON	
12,0 cm, 4 <sup>3</sup> / <sub>4</sub> "	<b>KI-1021-175</b>
15,0 cm, 6"	<b>KI-1021-176</b>



MICRO-ADSON	
12,0 cm, 4 <sup>3</sup> / <sub>4</sub> "	<b>KI-1021-177</b>
15,0 cm, 6"	<b>KI-1021-178</b>



Chirurgische Pinzetten  
 Tissue Forceps  
 Pinzas quirúrgicas  
 Pinze per chirurgia



**ADSON**  
 12,0 cm, 4<sup>3</sup>/<sub>4</sub>" **KI-1021-179**  
 15,0 cm, 6" **KI-1021-180**



**ADSON-BROWN**  
 12,0 cm, 4<sup>3</sup>/<sub>4</sub>" **KI-1021-181**  
 15,0 cm, 6" **KI-1021-182**



**ADSON**  
 12,0 cm, 4<sup>3</sup>/<sub>4</sub>" **KI-1021-183**



**STILLE**  
 15,0 cm, 6" **KI-1021-184**



**STILLE**  
 15,0 cm, 6" **KI-1021-185**



**GILLIES**  
 15,0 cm, 6" **KI-1021-186**



**ADLERKREUTZ**  
 15,0 cm, 6" **KI-1021-187**  
 20,0 cm, 8" **KI-1021-188**



**ADLERKREUTZ**  
 15,0 cm, 6" **KI-1021-189**  
 20,0 cm, 8" **KI-1021-190**

Chirurgische Pinzetten  
 Tissue Forceps  
 Pinzas quirúrgicas  
 Pinze per chirurgia



**SEMKEN**  
 12,5 cm, 5" **KI-1021-191**  
 15,5 cm, 6" **KI-1021-192**



**SEMKEN**  
 12,5 cm, 5"  
**KI-1021-193**



**MC INDOE**  
 15,0 cm, 6"  
**KI-1021-194**



**TAYLOR**  
 17,5 cm, 6<sup>5</sup>/<sub>8</sub>"  
**KI-1021-195**



**TAYLOR**  
 17,5 cm, 6<sup>5</sup>/<sub>8</sub>"  
**KI-1021-196**



**TAYLOR**  
 17,5 cm, 6<sup>5</sup>/<sub>8</sub>"  
**KI-1021-197**



**GERALD**  
 18,0 cm, 7"  
**KI-1021-198**



**GERALD**  
 18,0 cm, 7"  
**KI-1021-199**

# General Surgery Instruments



"Supporting Healthcare"  
**KAHA INDUSTRIES**  
 Manufacturer Of Dental & Surgical Instruments

Chirurgische Pinzetten  
 Tissue Forceps  
 Pinzas quirúrgicas  
 Pinze per chirurgia



**CUSHING**  
 17,5 cm, 6<sup>5</sup>/<sub>8</sub>"  
**KI-1021-200**



**CUSHING**  
 17,5 cm, 6<sup>5</sup>/<sub>8</sub>"  
**KI-1021-201**



**POTTS-SMITH**  
 18,0 cm, 7" **KI-1021-202**  
 21,0 cm, 8<sup>1</sup>/<sub>4</sub>" **KI-1021-203**  
 25,0 cm, 10" **KI-1021-204**



**POTTS-SMITH**  
 18,0 cm, 7" **KI-1021-205**  
 21,0 cm, 8<sup>1</sup>/<sub>4</sub>" **KI-1021-206**  
 25,0 cm, 10" **KI-1021-207**



**WAUGH**  
 15,0 cm, 6" **KI-1021-208**  
 20,0 cm, 8" **KI-1021-209**



**BROPHY**  
 20,0 cm, 8"  
**KI-1021-210**



**BROPHY**  
 20,0 cm, 8"  
**KI-1021-211**



**RUSS. MODELL**  
 15,0 cm, 6" **KI-1021-212**  
 20,0 cm, 8" **KI-1021-213**  
 25,0 cm, 10" **KI-1021-214**

Chirurgische Pinzetten  
 Tissue Forceps  
 Pinzas quirúrgicas  
 Pinze per chirurgia



**DURANTE**

14,5 cm, 5<sup>3</sup>/<sub>4</sub>" **KI-1021-215**  
 16,0 cm, 6<sup>1</sup>/<sub>4</sub>" **KI-1021-216**  
 20,0 cm, 8" **KI-1021-217**



**DUEHRSEN**

20,0 cm, 8"

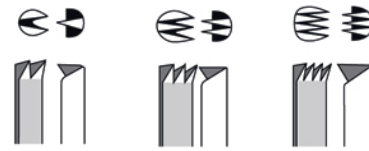

1 x 2 **KI-1021-218**    2 x 3 **KI-1021-219**    1 x 4 **KI-1021-220**



**NELSON**

15,0 cm, 6" **KI-1021-221**  
 20,0 cm, 8" **KI-1021-222**  
 23,0 cm, 9" **KI-1021-223**



**DUVAL**

14,0 cm, 5<sup>1</sup>/<sub>2</sub>"

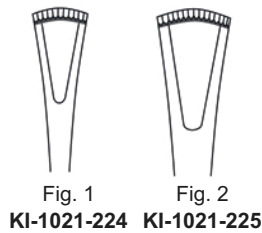

Fig. 1 **KI-1021-224**    Fig. 2 **KI-1021-225**



**COLLIN-DUVAL**

20,0 cm, 8"

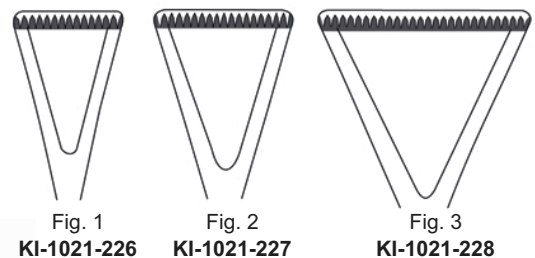

Fig. 1 **KI-1021-226**    Fig. 2 **KI-1021-227**    Fig. 3 **KI-1021-228**

# General Surgery Instruments



"Supporting Healthcare"  
**KAHA INDUSTRIES**  
 Manufacturer Of Dental & Surgical Instruments

Chirurgische Pinzetten  
 Tissue Forceps  
 Pinzas quirúrgicas  
 Pinze per chirurgia



**LANE**  
 14,5 cm, 5<sup>3</sup>/<sub>4</sub>" **KI-1021-229**  
 20,0 cm, 8" **KI-1021-230**



**LANE**  
 14,5 cm, 5<sup>3</sup>/<sub>4</sub>" **KI-1021-231**  
 20,0 cm, 8" **KI-1021-232**



**BROWN**  
 15,0 cm, 6" **KI-1021-233**  
 20,0 cm, 8" **KI-1021-234**  
 25,0 cm, 10" **KI-1021-235**



**TREVES**  
 13,0 cm, 5" **KI-1021-236**  
 15,0 cm, 6" **KI-1021-237**



**RAMSEY**  
 18,0 cm, 7"  
**KI-1021-238**



**RAMSEY**  
 18,0 cm, 7"  
**KI-1021-239**



**RAMSEY**  
 18,0 cm, 7"  
**KI-1021-240**



**RAMSEY**  
 18,0 cm, 7"  
**KI-1021-241**

Splitterpinzetten  
 Splinter Forceps  
 Pinzas para espinas  
 Pinze per schegge

1 x 2



8,0 cm, 3<sup>1</sup>/<sub>4</sub>" **KI-1021-242**  
 9,0 cm, 3<sup>1</sup>/<sub>2</sub>" **KI-1021-243**  
 10,5 cm, 4<sup>1</sup>/<sub>8</sub>" **KI-1021-244**  
 11,5 cm, 4<sup>1</sup>/<sub>2</sub>" **KI-1021-245**  
 13,0 cm, 5" **KI-1021-246**  
 14,5 cm, 5<sup>1</sup>/<sub>2</sub>" **KI-1021-247**



8,0 cm, 3<sup>1</sup>/<sub>4</sub>" **KI-1021-248**  
 9,0 cm, 3<sup>1</sup>/<sub>2</sub>" **KI-1021-249**  
 10,5 cm, 4<sup>1</sup>/<sub>8</sub>" **KI-1021-250**  
 11,5 cm, 4<sup>1</sup>/<sub>2</sub>" **KI-1021-251**  
 13,0 cm, 5" **KI-1021-252**  
 14,5 cm, 5<sup>1</sup>/<sub>2</sub>" **KI-1021-253**



8,0 cm, 3<sup>1</sup>/<sub>4</sub>" **KI-1021-254**  
 9,0 cm, 3<sup>1</sup>/<sub>2</sub>" **KI-1021-255**  
 10,5 cm, 4<sup>1</sup>/<sub>8</sub>" **KI-1021-256**  
 11,5 cm, 4<sup>1</sup>/<sub>2</sub>" **KI-1021-257**  
 13,0 cm, 5" **KI-1021-258**  
 14,5 cm, 5<sup>1</sup>/<sub>2</sub>" **KI-1021-259**



8,0 cm, 3<sup>1</sup>/<sub>4</sub>" **KI-1021-260**  
 9,0 cm, 3<sup>1</sup>/<sub>2</sub>" **KI-1021-261**  
 10,5 cm, 4<sup>1</sup>/<sub>8</sub>" **KI-1021-262**  
 11,5 cm, 4<sup>1</sup>/<sub>2</sub>" **KI-1021-263**  
 13,0 cm, 5" **KI-1021-264**  
 14,5 cm, 5<sup>1</sup>/<sub>2</sub>" **KI-1021-265**

Splitterpinzetten, Mikro-Pinzetten  
 Splinter Forceps, Micro Forceps  
 Pinzas para espinas, Pinzas para microscopia  
 Pinze per schegge, Pinze per microscopia



**HUNTER**  
 10,5 cm, 4 1/4"  
 KI-1021-266



**HUNTER**  
 10,5 cm, 4 1/4"  
 KI-1021-266



**WALTER-CARMALT**  
 10,5 cm, 4 1/4"  
 KI-1021-267



**WALTER-CARMALT**  
 10,5 cm, 4 1/4"  
 KI-1021-268



**FEILCHENFELD**  
 7,5 cm, 3 1/8" **KI-1021-269**  
 9,0 cm, 3 1/2" **KI-1021-270**  
 11,5 cm, 4 1/2" **KI-1021-271**



10,0 cm, 4"  
**KI-1021-272**



10,0 cm, 4"  
**KI-1021-273**



10,0 cm, 4"  
**KI-1021-274**  
 selbsthaltend  
 glatt

Mikro-Pinzetten  
Micro Forceps  
Pinzas para microscopia  
Pinze per microscopia



**GRAEFE**  
10,0 cm, 4"  
KI-1021-275



**GRAEFE**  
10,0 cm, 4"  
KI-1021-276



**GRAEFE**  
10,0 cm, 4"  
KI-1021-277



**GRAEFE**  
10,0 cm, 4"  
KI-1021-278



**GRAEFE**  
10,0 cm, 4"  
KI-1021-279



**GRAEFE**  
10,0 cm, 4"  
KI-1021-280



Uhrmacher Pinzetten, Gefäßdilatoren  
 Jeweller's Forceps, Vessel Dilators  
 Pinzas de relojería, Diladores vasculares  
 Pinze per orologiaio, Dilatori vascolari



Fig. 3  
 11,5 cm, 4 1/2"  
 KI-1021-281

0,3 mm x 45°



Fig. 4  
 11,5 cm, 4 1/2"  
 KI-1021-282

0,3 mm x 90°



Fig. 5  
 11,5 cm, 4 1/2"  
 KI-1021-283

0,3 mm



Fig. 7  
 11,5 cm, 4 1/2"  
 KI-1021-284

0,3 mm x 45°



11,0 cm, 4 3/8"  
 KI-1021-285

9 mm



11,0 cm, 4 3/8"  
 KI-1021-286

9 mm



11,0 cm, 4 3/8"  
 KI-1021-287

9 mm



11,0 cm, 4 3/8"  
 KI-1021-288

diamantbeschichtet  
 diamond coated  
 diamantado  
 diamantato

Gefäßdilatoren, Atraumatische Pinzetten  
 Vessel Dilators, Atraumatic Forceps  
 Dilatadores vasculares, Pinzas atraumáticas  
 Dilatatori vascolari, Pinze anatomiche atraumatica



12,0 cm, 4<sup>3</sup>/<sub>4</sub>"  
**KI-1021-289**



13,5 cm, 5<sup>3</sup>/<sub>8</sub>"  
**KI-1021-290**



13,5 cm, 5<sup>3</sup>/<sub>8</sub>"  
**KI-1021-290**



13,5 cm, 5<sup>3</sup>/<sub>8</sub>"  
**KI-1021-290**

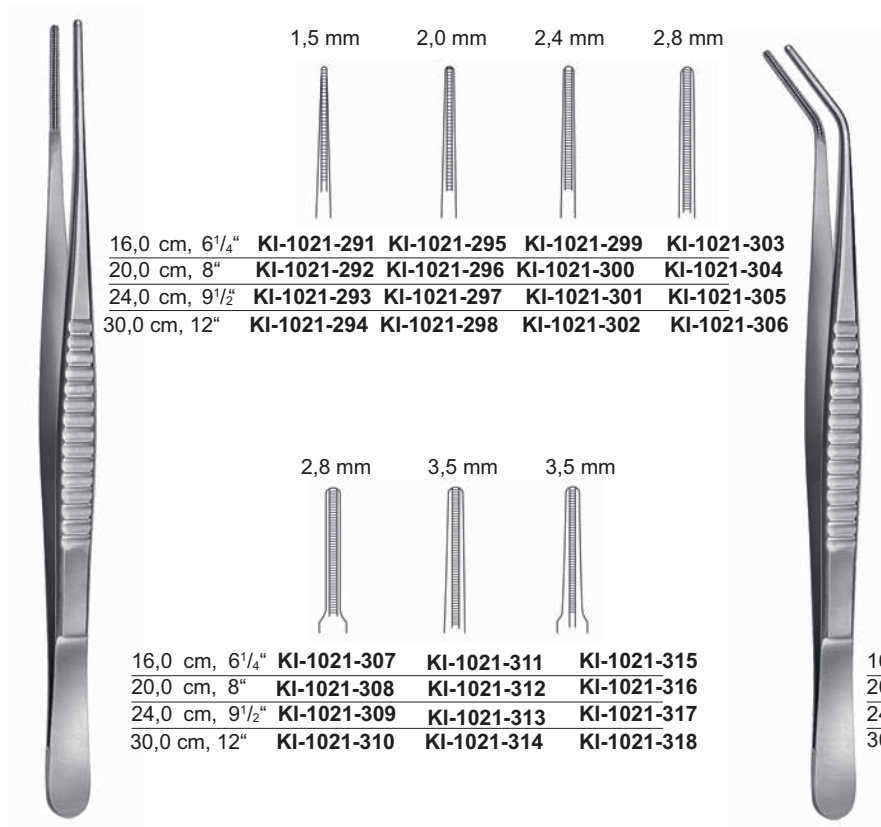

	1,5 mm	2,0 mm	2,4 mm	2,8 mm
16,0 cm, 6 <sup>1</sup> / <sub>4</sub> "	<b>KI-1021-291</b>	<b>KI-1021-295</b>	<b>KI-1021-299</b>	<b>KI-1021-303</b>
20,0 cm, 8"	<b>KI-1021-292</b>	<b>KI-1021-296</b>	<b>KI-1021-300</b>	<b>KI-1021-304</b>
24,0 cm, 9 <sup>1</sup> / <sub>2</sub> "	<b>KI-1021-293</b>	<b>KI-1021-297</b>	<b>KI-1021-301</b>	<b>KI-1021-305</b>
30,0 cm, 12"	<b>KI-1021-294</b>	<b>KI-1021-298</b>	<b>KI-1021-302</b>	<b>KI-1021-306</b>

	2,8 mm	3,5 mm	3,5 mm
16,0 cm, 6 <sup>1</sup> / <sub>4</sub> "	<b>KI-1021-307</b>	<b>KI-1021-311</b>	<b>KI-1021-315</b>
20,0 cm, 8"	<b>KI-1021-308</b>	<b>KI-1021-312</b>	<b>KI-1021-316</b>
24,0 cm, 9 <sup>1</sup> / <sub>2</sub> "	<b>KI-1021-309</b>	<b>KI-1021-313</b>	<b>KI-1021-317</b>
30,0 cm, 12"	<b>KI-1021-310</b>	<b>KI-1021-314</b>	<b>KI-1021-318</b>

	1,5 mm	2,0 mm
16,0 cm, 6 <sup>1</sup> / <sub>4</sub> "	<b>KI-1021-319</b>	<b>KI-1021-323</b>
20,0 cm, 8"	<b>KI-1021-320</b>	<b>KI-1021-324</b>
24,0 cm, 9 <sup>1</sup> / <sub>2</sub> "	<b>KI-1021-321</b>	<b>KI-1021-325</b>
30,0 cm, 12"	<b>KI-1021-322</b>	<b>KI-1021-326</b>

DE BAKEY

DE BAKEY

# General Surgery Instruments



"Supporting Healthcare"  
**KAAHA INDUSTRIES**  
 Manufacturer Of Dental & Surgical Instruments

Pinzetten mit Hartmetalleinlagen  
 Forceps with tungsten carbide inserts  
 Pinzas con bocas de carburo tungsteno  
 Pinze con morsi in carburo di tungsteno



STANDARD	
14,5 cm, 5 <sup>3</sup> / <sub>4</sub> "	<b>KI-1021-327</b>
16,0 cm, 6 <sup>1</sup> / <sub>4</sub> "	<b>KI-1021-328</b>
18,0 cm, 7"	<b>KI-1021-329</b>
20,0 cm, 8"	<b>KI-1021-330</b>
25,0 cm, 10"	<b>KI-1021-331</b>
30,0 cm, 12"	<b>KI-1021-332</b>

STANDARD	
14,0 cm, 5 <sup>1</sup> / <sub>2</sub> "	<b>KI-1021-333</b>
16,0 cm, 6 <sup>1</sup> / <sub>4</sub> "	<b>KI-1021-334</b>
18,0 cm, 7"	<b>KI-1021-335</b>
20,0 cm, 8"	<b>KI-1021-336</b>
25,0 cm, 10"	<b>KI-1021-337</b>
30,0 cm, 12"	<b>KI-1021-338</b>

STANDARD	
12,5 cm, 5"	<b>KI-1021-339</b>
15,0 cm, 6"	<b>KI-1021-340</b>

STANDARD	
15,0 cm, 6"	<b>KI-1021-341</b>
23,0 cm, 9"	<b>KI-1021-342</b>
25,0 cm, 10"	<b>KI-1021-343</b>

Pinzetten mit Hartmetalleinlagen  
 Forceps with tungsten carbide inserts  
 Pinzas con bocas de carburo tungsteno  
 Pinze con morsi in carburo di tungsteno



**GILLIES**  
 15,0 cm, 6"  
 KI-1021-344



**MC INDOE**  
 15,0 cm, 6"  
 KI-1021-345



**GERALD**  
 17,0 cm, 6<sup>3</sup>/<sub>4</sub>"



017-1102-17



017-1302-17



**POTTS-SMITH**  
 15,0 cm, 6" KI-1021-346  
 18,0 cm, 7" KI-1021-347  
 20,0 cm, 8" KI-1021-348



**BONNEY**  
 17,5 cm, 6<sup>5</sup>/<sub>8</sub>"  
 KI-1021-349



**CUSHING**  
 17,5 cm, 6<sup>5</sup>/<sub>8</sub>"

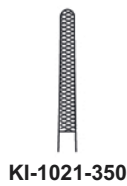

KI-1021-350

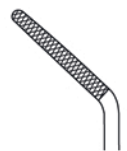

KI-1021-351



**CUSHING-TAYLOR**  
 18,0 cm, 7"  
 KI-1021-352



12,0 cm, 4<sup>3</sup>/<sub>4</sub>"  
 KI-1021-353



12,0 cm, 4<sup>3</sup>/<sub>4</sub>"  
 KI-1021-354



15,0 cm, 6"  
 KI-1021-355



15,0 cm, 6"  
 KI-1021-356



“Supporting Healthcare”

**KAAHA INDUSTRIES**

Manufacturer Of Dental & Surgical Instruments

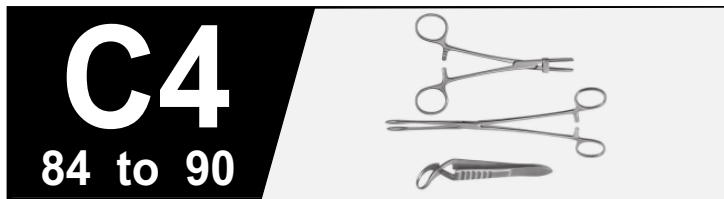

Tuch-, Schlauchklemmen, Tupferzangen

Towel Clamps, Sponge and Dressing Forceps, Tubing Clamps

Pinzas de campo, Pinzas para vendajes y torundas y para tubos

Pinze per fissare le compresse, per medicatura e tamponi, e per tubi

# General Surgery Instruments



"Supporting Healthcare"  
**KAHA INDUSTRIES**  
 Manufacturer Of Dental & Surgical Instruments

Tuchklemmen  
 Towel Clamps  
 Pinzas de campo  
 Pinze per fissare le compresse



**SCHAEDEL**  
 9,0 cm, 3 1/2"  
**KI-1031-01**



**ENGL. MODELL**  
 9,0 cm, 3 1/2"  
**KI-1031-02**



**JONES**

5,0 cm, 2"	<b>KI-1031-03</b>
7,0 cm, 2 3/4"	<b>KI-1031-04</b>
9,0 cm, 3 1/2"	<b>KI-1031-05</b>



**JONES**  
 9,0 cm, 3 1/2"  
**KI-1031-06**

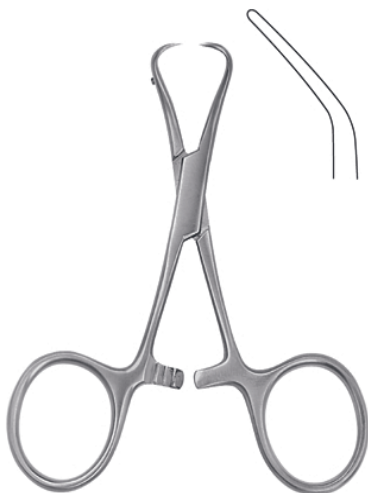

**BACKHAUS**

9,0 cm, 3 1/2"	<b>KI-1031-07</b>
11,0 cm, 4 3/8"	<b>KI-1031-08</b>
13,0 cm, 5"	<b>KI-1031-09</b>
15,0 cm, 6"	<b>KI-1031-10</b>



mit Schlauch- oder Kabelhalter  
 with clip for tubing or cable  
 con porta-tubo o porta-cable  
 con porta-tubo o porta-cavo

11,0 cm, 4 3/8"  
**KI-1031-11**

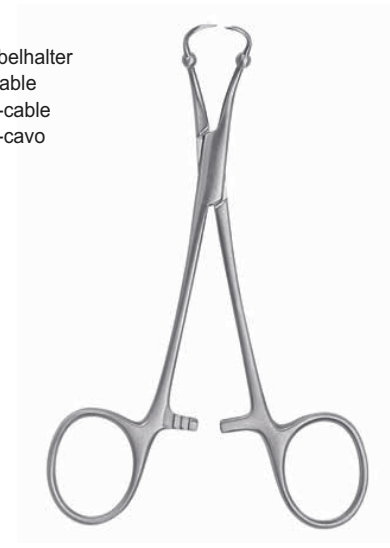

**ROEDER**  
 13,0 cm, 5"  
**KI-1031-12**

Tuchklemmen  
 Towel Clamps  
 Pinzas de campo  
 Pinze per fissare le compresse



**ROEDER**  
 15,0 cm, 5"  
**KI-1031-13**



**BERNHARD**  
 16,5 cm, 6½"  
**KI-1031-14**

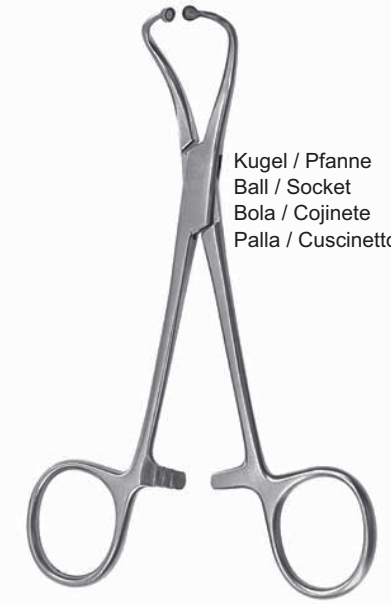

Kugel / Pfanne  
 Ball / Socket  
 Bola / Cojinete  
 Palla / Cuscinetto

13,0 cm, 5"  
**KI-1031-15**

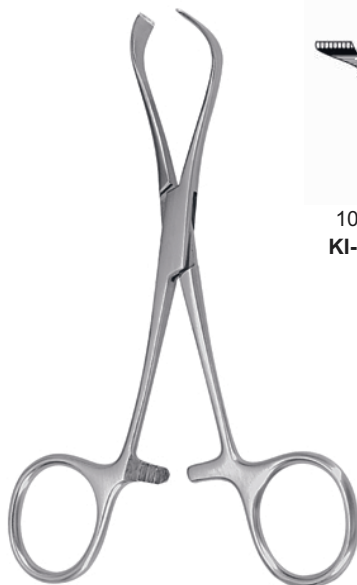
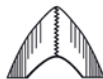

**LORNA**



10,0 cm, 4" **KI-1031-16**    13,0 cm, 5" **KI-1031-17**



**LANE**  
 15,0 cm, 6" **KI-1031-18**  
 18,0 cm, 7" **KI-1031-19**  
 20,0 cm, 8" **KI-1031-20**

Tuchklemmen, Korn- und Tupferzangen  
 Towel Clamps, Sponge and Dressing Forceps  
 Pinzas de campo, Pinzas para vendajes y torundas  
 Pinze per fissare le compresse, Pinze per medicatura e tamponi



**TOHOKU**



10,0 cm, 4" **KI-1031-21**    13,0 cm, 5" **KI-1031-22**



**PEERS**  
 14,5 cm, 5<sup>3</sup>/<sub>4</sub>"  
**KI-1031-23**



**LISTER**  
 13,0 cm, 5" **KI-1031-24**  
 16,0 cm, 6<sup>1</sup>/<sub>4</sub>" **KI-1031-25**  
 18,0 cm, 7" **KI-1031-26**



**BRYANT**  
 13,0 cm, 5"  
**KI-1031-27**

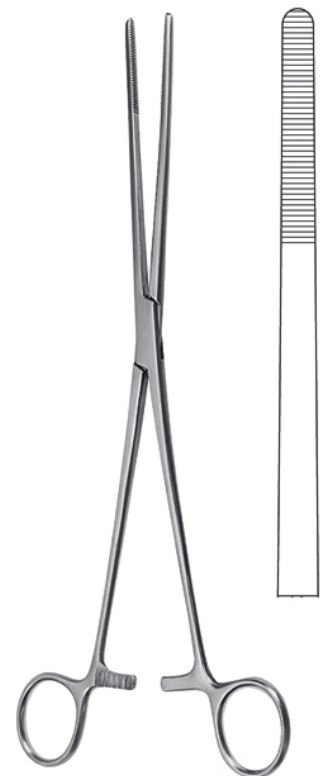

**BOZEMANN**  
 26,0 cm, 10<sup>1</sup>/<sub>4</sub>"  
**KI-1031-28**



**Korn- und Tupferzangen**  
**Sponge and Dressing Forceps**  
**Pinzas para vendajes y torundas**  
**Pinze per medicatura e tamponi**

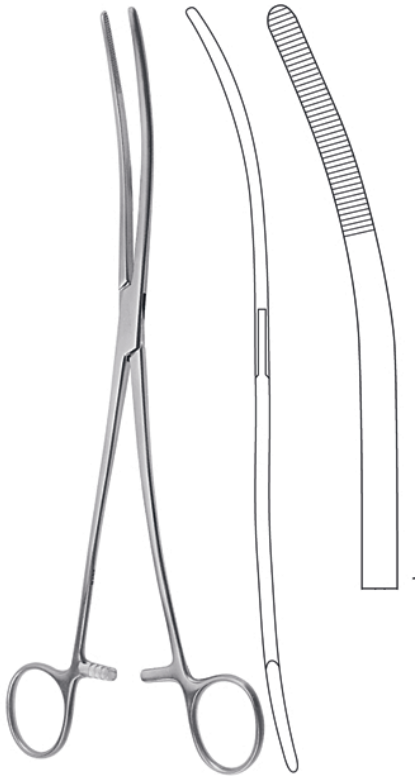

**BOZEMANN**  
 26,0 cm, 10<sup>1</sup>/<sub>4</sub>"  
 KI-1031-29



**COLLIN**  
 25,0 cm, 9<sup>3</sup>/<sub>4</sub>"  
 KI-1031-30



**CHERON**  
 25,0 cm, 9<sup>3</sup>/<sub>4</sub>"  
 KI-1031-31



**PERLMANN**  
 25,0 cm, 9<sup>3</sup>/<sub>4</sub>"

KI-1031-32



KI-1031-33



**ULRICH**

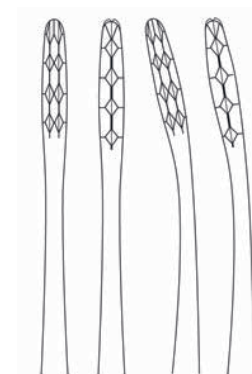

22,0 cm, 8 <sup>5</sup> / <sub>8</sub> "	<b>KI-1031-34</b>	<b>KI-1031-37</b>
25,0 cm, 9 <sup>3</sup> / <sub>4</sub> "	<b>KI-1031-35</b>	<b>KI-1031-38</b>
27,0 cm, 10 <sup>5</sup> / <sub>8</sub> "	<b>KI-1031-36</b>	<b>KI-1031-39</b>

Korn- und Tupferzangen  
 Sponge and Dressing Forceps  
 Pinzas para vendajes y torundas  
 Pinze per medicatura e tamponi



**GROSS-MAIER**

20,0 cm, 8"	<b>KI-1031-40</b>	<b>KI-1031-44</b>
22,0 cm, 8 <sup>5</sup> / <sub>8</sub> "	<b>KI-1031-41</b>	<b>KI-1031-45</b>
25,0 cm, 9 <sup>3</sup> / <sub>4</sub> "	<b>KI-1031-42</b>	<b>KI-1031-46</b>
27,0 cm, 10 <sup>5</sup> / <sub>8</sub> "	<b>KI-1031-43</b>	<b>KI-1031-47</b>

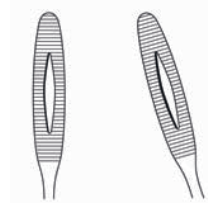

**FOERSTER**

25,0 cm, 9<sup>3</sup>/<sub>4</sub>"  
**KI-1031-48**

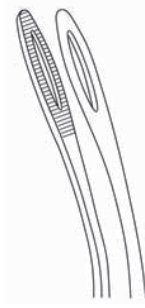

25,0 cm, 9<sup>3</sup>/<sub>4</sub>"  
**KI-1031-49**



**FOERSTER-BALLEGER**

18,0 cm, 7"	<b>KI-1031-50</b>	<b>KI-1031-53</b>	<b>KI-1031-56</b>	<b>KI-1031-59</b>
20,0 cm, 8"	<b>KI-1031-51</b>	<b>KI-1031-54</b>	<b>KI-1031-57</b>	<b>KI-1031-60</b>
25,0 cm, 9 <sup>3</sup> / <sub>4</sub> "	<b>KI-1031-52</b>	<b>KI-1031-55</b>	<b>KI-1031-58</b>	<b>KI-1031-61</b>

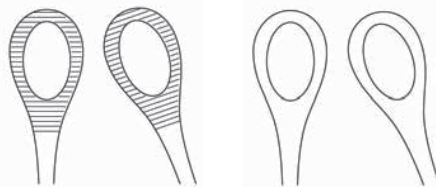

**RAMPLEY**

18,0 cm, 7"	<b>KI-1031-62</b>
25,0 cm, 9 <sup>3</sup> / <sub>4</sub> "	<b>KI-1031-63</b>

Schlauchklemmen  
 Tubing Clamps  
 Pinzas para tubos  
 Pinze per tubi

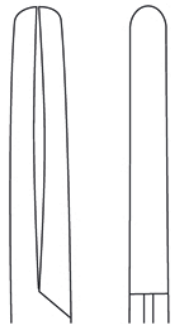

**PRESBYTERIAN**

- 16,5 cm, 6 1/2" **KI-1031-64**
- 18,0 cm, 7" **KI-1031-65**
- 20,0 cm, 8" **KI-1031-66**



**BERLIN**

- 14,5 cm, 5 3/4" **KI-1031-67**



- 15,0 cm, 6" **KI-1031-68**



- 18,0 cm, 7" **KI-1031-69**



- 20,0 cm, 8" **KI-1031-70**



- 15,0 cm, 6" **KI-1031-71**

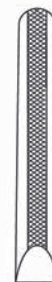

- 18,0 cm, 7" **KI-1031-72**



- 20,0 cm, 8" **KI-1031-73**

**MIT BÜGEL**



"Supporting Healthcare"

**KAAHA INDUSTRIES**

Manufacturer Of Dental & Surgical Instruments

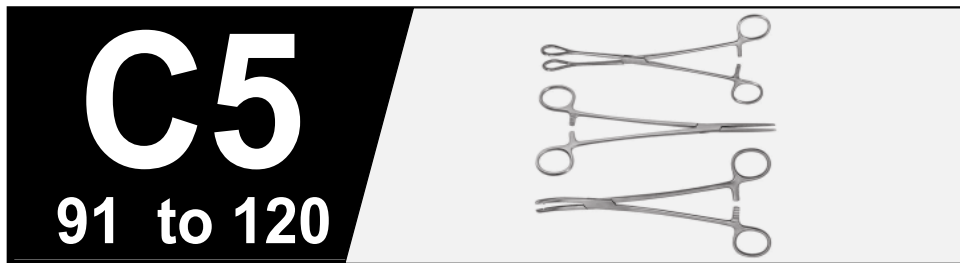

**Klemmen**

**Forceps**

**Pinas**

**Pinze**

# General Surgery Instruments



"Supporting Healthcare"  
**KAAHA INDUSTRIES**  
 Manufacturer Of Dental & Surgical Instruments

Bulldogklemmen  
 Bulldog Clamps  
 Clamps Bulldog  
 Pinze Bulldog



3,5 cm, 1 1/2"	<b>KI-1041-01</b>	<b>KI-1041-03</b>
5,0 cm, 2"	<b>KI-1041-02</b>	<b>KI-1041-04</b>



**HESS**  
 KI-1041-05



**HESS**  
 KI-1041-06



3,8 cm, 1 1/2"	<b>KI-1041-07</b>	<b>KI-1041-12</b>
5,0 cm, 2"	<b>KI-1041-08</b>	<b>KI-1041-13</b>
6,3 cm, 2 1/2"	<b>KI-1041-09</b>	<b>KI-1041-14</b>
7,6 cm, 3"	<b>KI-1041-10</b>	<b>KI-1041-15</b>
9,0 cm, 3 1/2"	<b>KI-1041-11</b>	<b>KI-1041-16</b>

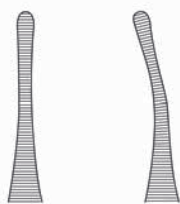

**JOHNS-HOPKINS**  
 23,0 cm, 9"  
 KI-1041-17

**JOHNS-HOPKINS**

**Bulldogklemmen**  
**Bulldog Clamps**  
**Clamps Bulldog**  
**Pinze Bulldog**

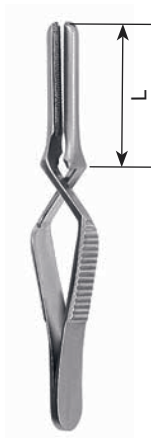

mit atraumatischer Riefung  
 with non-traumatic serration  
 con bocas atraumáticas  
 con presa atraumatica

		L	
7,5 cm, 3"	<b>KI-1041-18</b>	2,5 cm, 1"	
8,5 cm, 3 1/4"	<b>KI-1041-19</b>	3,5 cm, 1 3/8"	
10,5 cm, 4 1/8"	<b>KI-1041-20</b>	5,0 cm, 2"	
12,0 cm, 4 3/4"	<b>KI-1041-21</b>	6,8 cm, 2 3/4"	

**DE BAKEY**

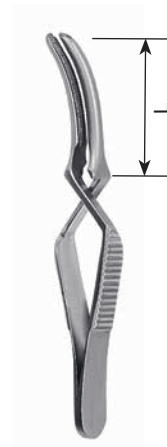

mit atraumatischer Riefung  
 with non-traumatic serration  
 con bocas atraumáticas  
 con presa atraumatica

		L	
7,0 cm, 2 3/4"	<b>KI-1041-22</b>	2,5 cm, 1"	
8,0 cm, 3 1/8"	<b>KI-1041-23</b>	3,5 cm, 1 3/8"	
10,0 cm, 3 3/4"	<b>KI-1041-24</b>	5,0 cm, 2"	
11,5 cm, 4 1/2"	<b>KI-1041-25</b>	6,8 cm, 2 3/4"	

**DE BAKEY**



**TITANIUM**  
 3,5 cm, 1 3/8"  
 vena **KI-1041-26**  
 arteria **KI-1041-27**



**TITANIUM**  
 3,5 cm, 1 3/8"  
 vena **KI-1041-28**  
 arteria **KI-1041-29**



**TITANIUM**  
 4,0 cm, 1 5/8"  
 vena **KI-1041-30**  
 arteria **KI-1041-31**



**TITANIUM**  
 4,0 cm, 1 5/8"  
 vena **KI-1041-32**  
 arteria **KI-1041-33**

Bulldogklemmen, Darm- und Gewebefaßzangen  
 Bulldog Clamps, Intestinal and Tissue Grasping Forceps  
 Clamps Bulldog, Pinzas intestinales y para tejidos  
 Pinze Bulldog, Pinze da presa per intestino e tessuti

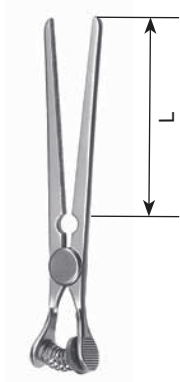

		L	
6,8 cm, 2 <sup>3</sup> / <sub>4</sub> "	<b>KI-1041-34</b>	3,3 cm, 1 <sup>3</sup> / <sub>8</sub> "	
9,6 cm, 3 <sup>3</sup> / <sub>4</sub> "	<b>KI-1041-35</b>	5,0 cm, 2"	
11,7 cm, 4 <sup>3</sup> / <sub>4</sub> "	<b>KI-1041-36</b>	6,9 cm, 2 <sup>3</sup> / <sub>4</sub> "	

GLOVER

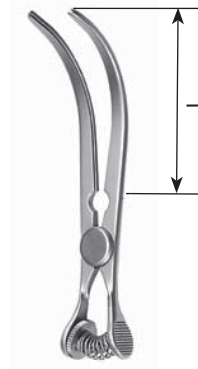

		L	
6,5 cm, 2 <sup>1</sup> / <sub>2</sub> "	<b>KI-1041-37</b>	3,3 cm, 1 <sup>3</sup> / <sub>8</sub> "	
9,1 cm, 3 <sup>1</sup> / <sub>2</sub> "	<b>KI-1041-38</b>	5,0 cm, 2"	
11,0 cm, 4 <sup>3</sup> / <sub>8</sub> "	<b>KI-1041-39</b>	6,9 cm, 2 <sup>3</sup> / <sub>4</sub> "	

GLOVER



**CHAPUT**  
 13,0 cm, 5"  
**KI-1041-40**



**TUFFIER**  
 13,0 cm, 5"  
**KI-1041-41**



**COLLIN**  
 16,0 cm, 6<sup>1</sup>/<sub>4</sub>"  
**KI-1041-42**

Darm- und Gewebefäßzangen  
 Intestinal and Tissue Grasping Forceps  
 Pinzas intestinales y para tejidos  
 Pinze da presa per intestino e tessuti



**PENNINGTON**  
 15,5 cm, 6" **KI-1041-43**  
 20,0 cm, 8" **KI-1041-44**



**ATRAUMA**



25,0 cm, 9<sup>3</sup>/<sub>4</sub>"  
**KI-1041-45**



27,0 cm, 10<sup>1</sup>/<sub>2</sub>"  
**KI-1041-46**

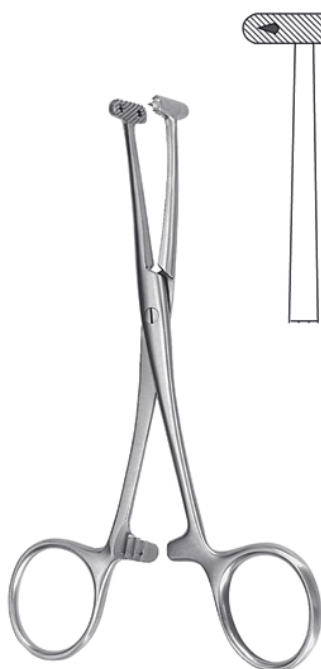

**MARTEL**  
 14,0 cm, 5<sup>1</sup>/<sub>2</sub>"  
**KI-1041-47**

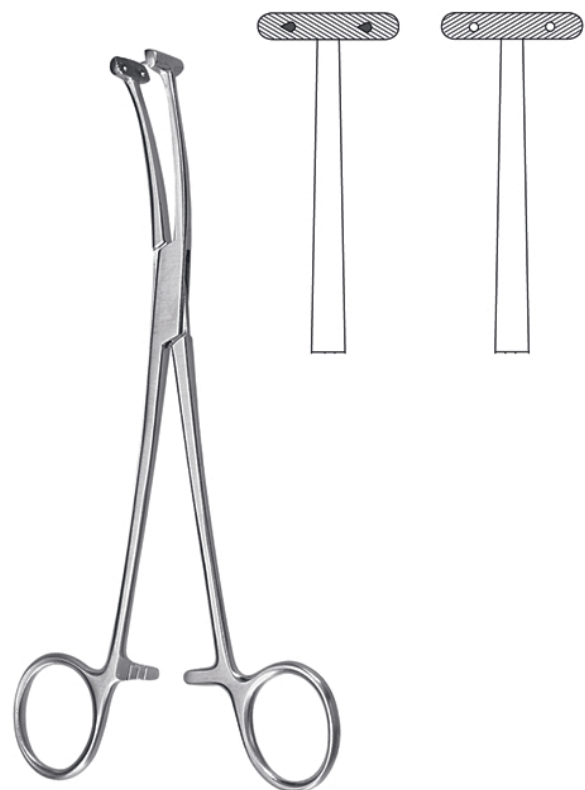

**WILLET-MARTEL**  
 19,0 cm, 7<sup>1</sup>/<sub>2</sub>"  
**KI-1041-48**



Arterienklemmen  
 Haemostatic Forceps  
 Pinzas hemostáticas  
 Pinze emostatiche



**PRATT**  
 15,0 cm, 6"  
 KI-1041-49



**FERGUSSON**

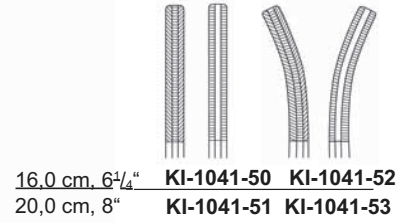

16,0 cm, 6<sup>3</sup>/<sub>4</sub>"    **KI-1041-50**    **KI-1041-52**  
 20,0 cm, 8"    **KI-1041-51**    **KI-1041-53**



**CARREL**  
 10,0 cm, 4"  
 KI-1041-54



**TERRIER**  
 10,0 cm, 4"  
 KI-1041-55



**KROENLEIN**  
 13,0 cm, 5"  
 KI-1041-56

Arterienklemmen  
 Haemostatic Forceps  
 Pinzas hemostáticas  
 Pinze emostatiche



**PEAN**

14,0 cm, 5 1/2"	<b>KI-1041-57</b>
16,0 cm, 6 1/4"	<b>KI-1041-58</b>

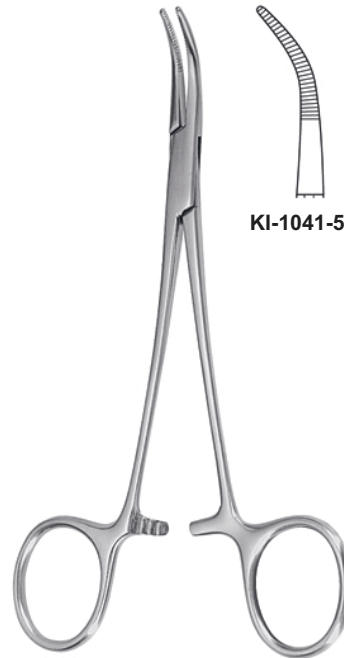

**BABY-MIXTER**

14,0 cm, 5 1/2"

**KI-1041-59**

**KI-1041-60**



**SPENCER-WELLS**

13,0 cm, 5"	<b>KI-1041-61</b>	<b>KI-1041-65</b>
15,0 cm, 6"	<b>KI-1041-62</b>	<b>KI-1041-66</b>
18,0 cm, 7"	<b>KI-1041-63</b>	<b>KI-1041-67</b>
20,0 cm, 8"	<b>KI-1041-64</b>	<b>KI-1041-68</b>

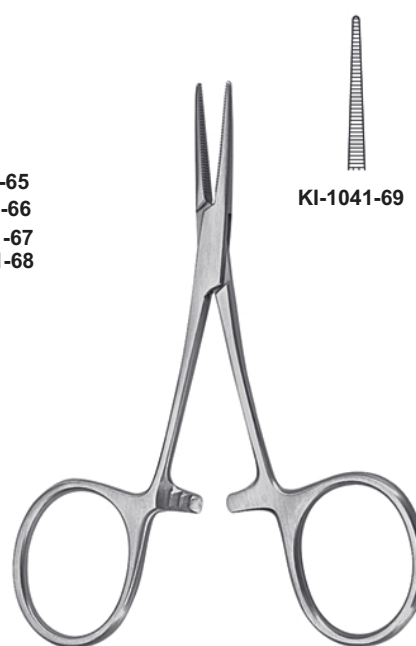

**HARTMANN**

10,0 cm, 4"

**KI-1041-69**

**KI-1041-70**

Arterienklemmen  
 Haemostatic Forceps  
 Pinzas hemostáticas  
 Pinze emostatiche

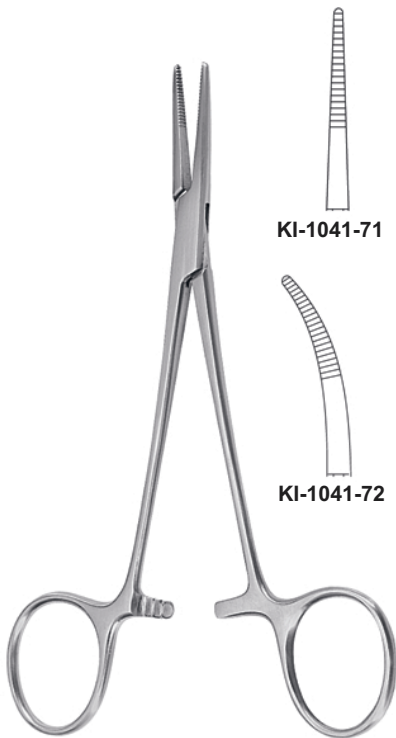

**PROVICENCE-HOSPITAL**  
 14,0 cm, 5½"



**HALSTED-MOSQUITO**

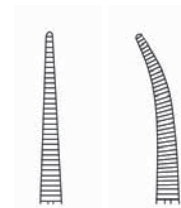

12,5 cm, 5" **KI-1041-73** **KI-1041-75**  
 25,0 cm, 9¾" **KI-1041-74** **KI-1041-76**

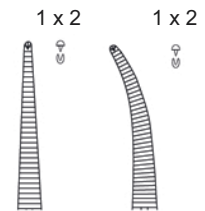

12,5 cm, 5" **KI-1041-77** **KI-1041-79**  
 25,0 cm, 9¾" **KI-1041-78** **KI-1041-80**



**HALSTED-MOSQUITO**



18,0 cm, 7"  
**KI-1041-81**



18,0 cm, 7"  
**KI-1041-82**



21,0 cm, 8¼"  
**KI-1041-83**



21,0 cm, 8¼"  
**KI-1041-84**

1 x 2



18,0 cm, 7"  
**KI-1041-85**

1 x 2



18,0 cm, 7"  
**KI-1041-86**

1 x 2



21,0 cm, 8¼"  
**KI-1041-87**

1 x 2



21,0 cm, 8¼"  
**KI-1041-88**

Arterienklemmen  
 Haemostatic Forceps  
 Pinzas hemostáticas  
 Pinze emostatiche



		1 x 2	1 x 2
10,0 cm, 4"	<b>KI-1041-89</b>	<b>KI-1041-91</b>	<b>KI-1041-93</b> <b>KI-1041-95</b>
12,0 cm, 4 <sup>3</sup> / <sub>4</sub> "	<b>KI-1041-90</b>	<b>KI-1041-92</b>	<b>KI-1041-94</b> <b>KI-1041-96</b>

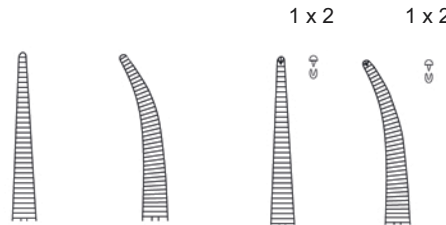

**MICRO-MOSQUITO**

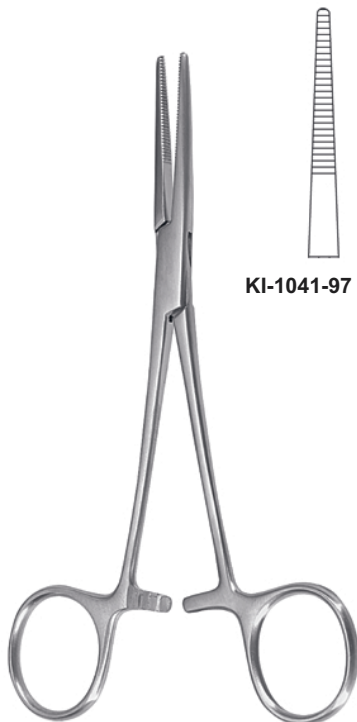

**KI-1041-97**



**KELLY**  
 14,0 cm, 5<sup>1</sup>/<sub>2</sub>"

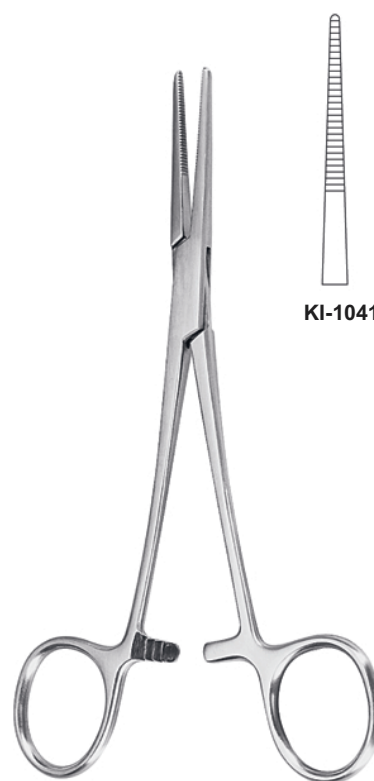

**KI-1041-99**

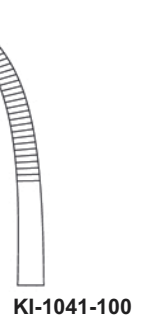

**KELLY-RANKIN**  
 16,0 cm, 6<sup>1</sup>/<sub>4</sub>"

Arterienklemmen  
 Haemostatic Forceps  
 Pinzas hemostáticas  
 Pinze emostatiche



**LERICHE**  
 15,0 cm, 6"



KI-5101-96



KI-5101-97

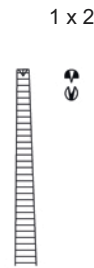

KI-5101-98



KI-5101-99



**BABY-OVERHOLT**  
 13,5 cm, 5 1/4"  
 KI-5201-01

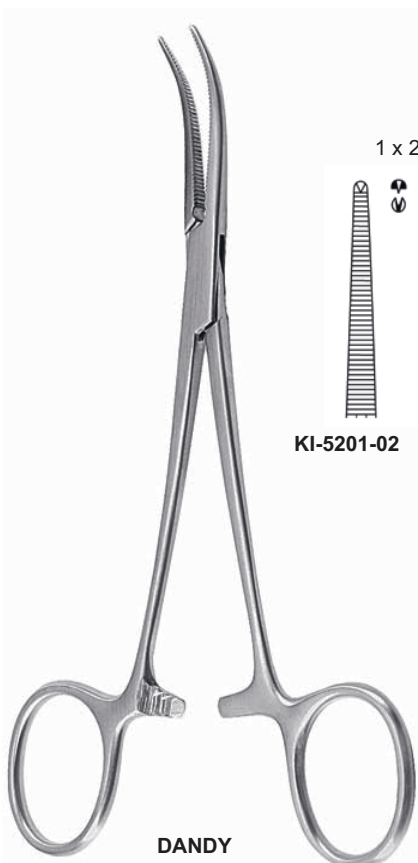

**DANDY**  
 14,0 cm, 5 1/2"



KI-5201-02



**CRILE**



KI-5201-03



KI-5201-04

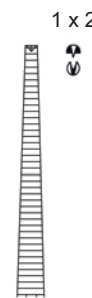

KI-5201-05

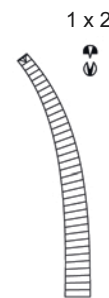

KI-5201-06

14,0 cm, 5 1/2"

Arterienklemmen  
 Haemostatic Forceps  
 Inzas hemostáticas  
 Pinze emostatiche

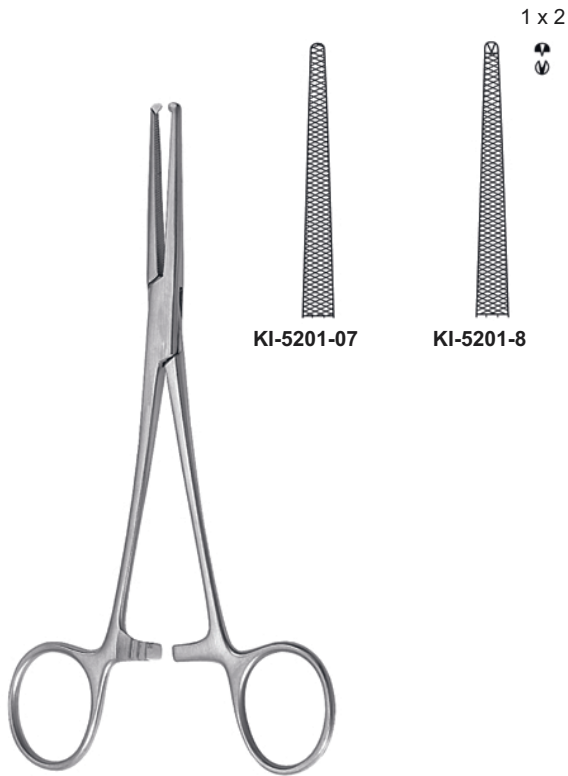

**DIXON-LOVELACE**  
 15,0 cm, 6"

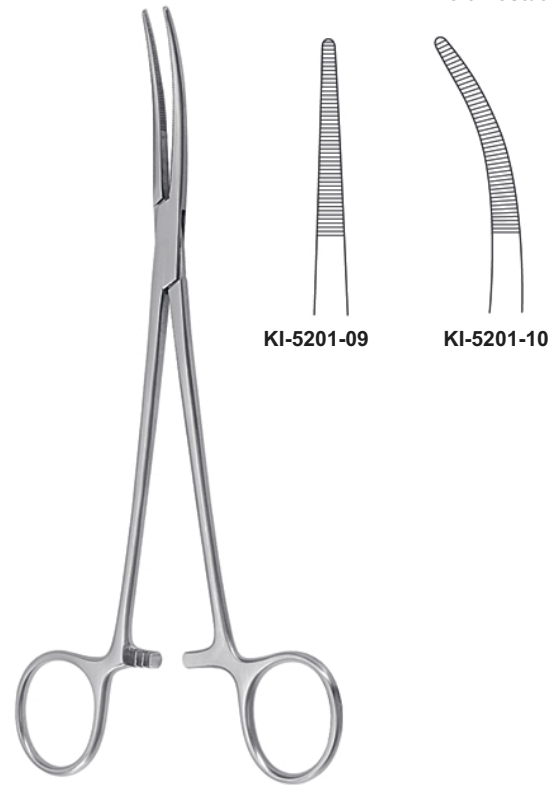

**BIRKETT**  
 19,0 cm, 7 1/2"



**CRILE-RANKIN**  
 16,0 cm, 6 1/4"

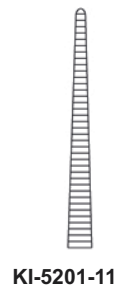

KI-5201-11



KI-5201-12

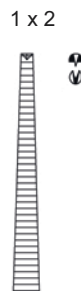

KI-5201-13



KI-5201-14

Arterienklemmen  
 Haemostatic Forceps  
 Pinzas hemostáticas  
 Pinze emostatiche



KI-5201-15

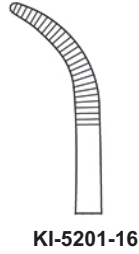

KI-5201-16



KI-5201-17

KI-5201-18

**SCHNIDT**  
 19,0 cm, 7 1/2"

**SCHNIKI-SAWTELL**  
 19,0



**ADSON**  
 18,5 cm, 7 1/4"



KI-5201-19

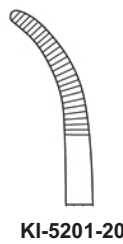

KI-5201-20

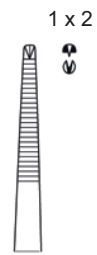

KI-5201-21

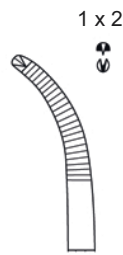

KI-5201-22

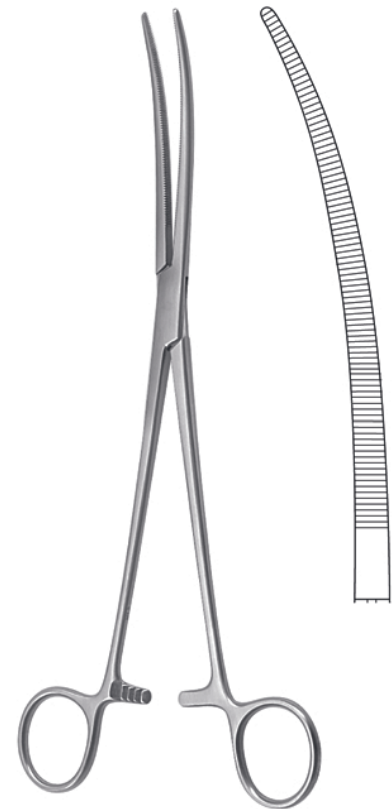

**CRAFOORD**  
 24,0 cm, 9 1/2"  
 KI-5201-23

Arterienklemmen  
 Haemostatic Forceps  
 Pinzas hemostáticas  
 Pinze emostatiche



15,0 cm, 6"    **KI-5201-24** **KI-5201-25**  
 18,5 cm, 7 1/4"    **KI-5201-26** **KI-5201-27**

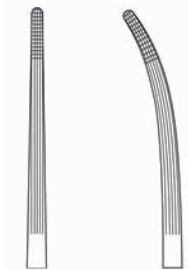

**BAINBRIDGE**



16,0 cm, 6 1/4"    **KI-5201-28** **KI-5201-29**  
 20,0 cm, 8"    **KI-5201-30** **KI-5201-31**

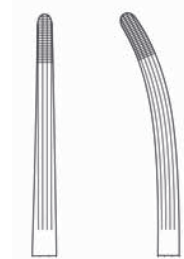

**ROCHESTER-CARMALT**



13,0 cm, 5"    **KI-5201-32** **KI-5201-33**  
 14,0 cm, 5 1/2"    **KI-5201-34** **KI-5201-35**  
 16,0 cm, 6 1/4"    **KI-5201-36** **KI-5201-37**

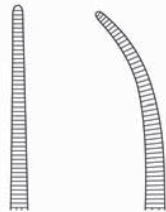

**PEAN DELICATE**



13,0 cm, 5"    **KI-5201-38** **KI-5201-39**  
 14,0 cm, 5 1/2"    **KI-5201-40** **KI-5201-41**  
 16,0 cm, 6 1/4"    **KI-5201-42** **KI-5201-43**

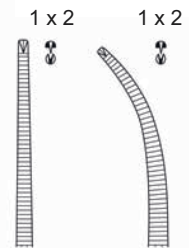

**KOCHER DELICATE**



Arterienklemmen  
 Haemostatic Forceps  
 Pinzas hemostáticas  
 Pinze emostatiche



**ROCHESTER-PEAN**

14,0 cm, 5½"	<b>KI-5201-44</b>	<b>KI-5201-45</b>
16,0 cm, 6¼"	<b>KI-5201-46</b>	<b>KI-5201-47</b>
18,0 cm, 7"	<b>KI-5201-48</b>	<b>KI-5201-49</b>
20,0 cm, 8"	<b>KI-5201-50</b>	<b>KI-5201-51</b>
22,0 cm, 8⅝"	<b>KI-5201-52</b>	<b>KI-5201-53</b>
24,0 cm, 9½"	<b>KI-5201-54</b>	<b>KI-5201-55</b>
26,0 cm, 10¼"	<b>KI-5201-56</b>	<b>KI-5201-57</b>
30,0 cm, 12"	<b>KI-5201-58</b>	<b>KI-5201-59</b>

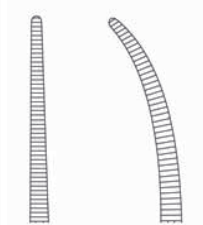

**KOCHER-OCHSNER**

14,0 cm, 5½"	<b>KI-5201-60</b>	<b>KI-5201-61</b>
16,0 cm, 6¼"	<b>KI-5201-62</b>	<b>KI-5201-63</b>
18,0 cm, 7"	<b>KI-5201-64</b>	<b>KI-5201-65</b>
20,0 cm, 8"	<b>KI-5201-66</b>	<b>KI-5201-67</b>
22,0 cm, 8⅝"	<b>KI-5201-68</b>	<b>KI-5201-69</b>
24,0 cm, 9½"	<b>KI-5201-70</b>	<b>KI-5201-71</b>
26,0 cm, 10¼"	<b>KI-5201-72</b>	<b>KI-5201-73</b>
30,0 cm, 12"	<b>KI-5201-74</b>	<b>KI-5201-75</b>

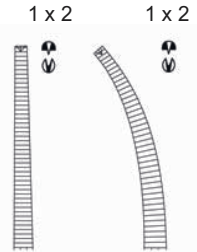

**BENGOLEA**

20,0 cm, 8"	<b>KI-5201-76</b>	<b>KI-5201-77</b>	<b>KI-5201-78</b>	<b>KI-5201-79</b>
26,0 cm, 10¼"	<b>KI-5201-80</b>	<b>KI-5201-81</b>	<b>KI-5201-82</b>	<b>KI-5201-83</b>

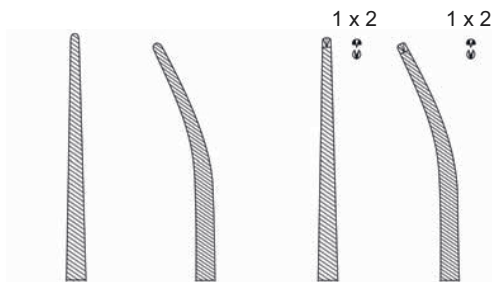

Arterienklemmen  
Haemostatic Forceps  
Pinzas hemostáticas  
Pinze emostatiche



**HEISS**  
20,0 cm, 8"

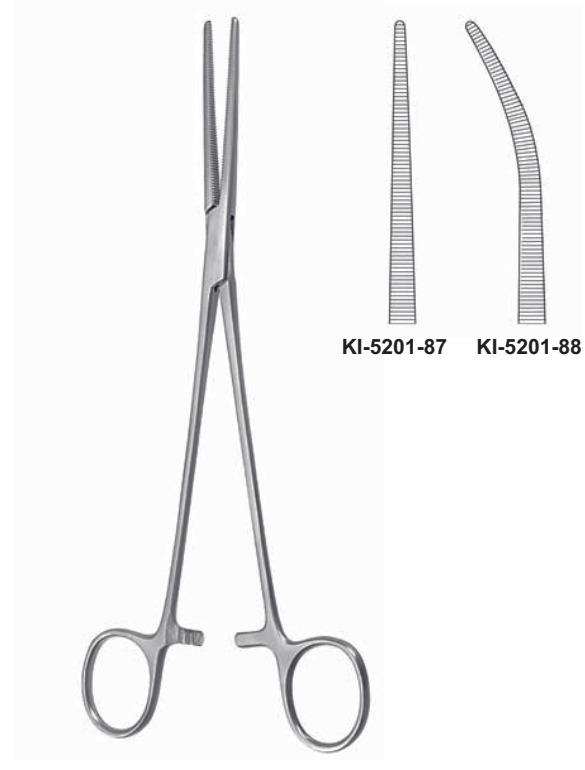

**ROBERTS**  
22,0 cm, 8<sup>5</sup>/<sub>8</sub>"

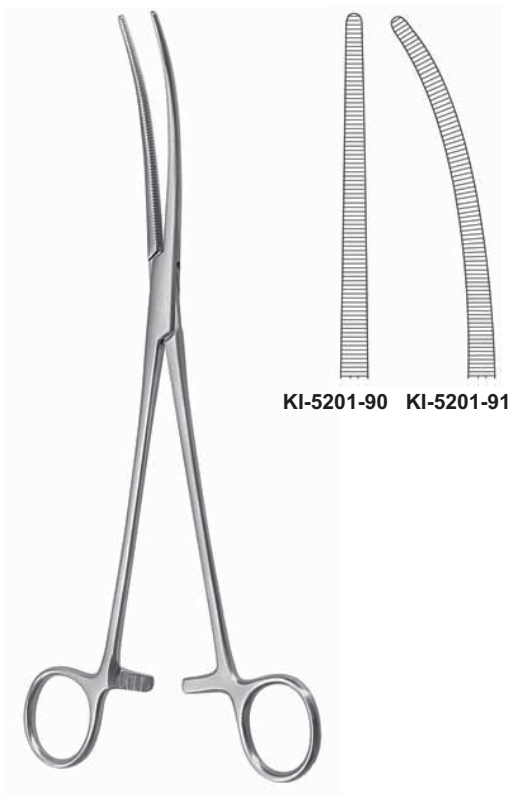

**SAROT**  
24,0 cm, 9<sup>1</sup>/<sub>2</sub>"

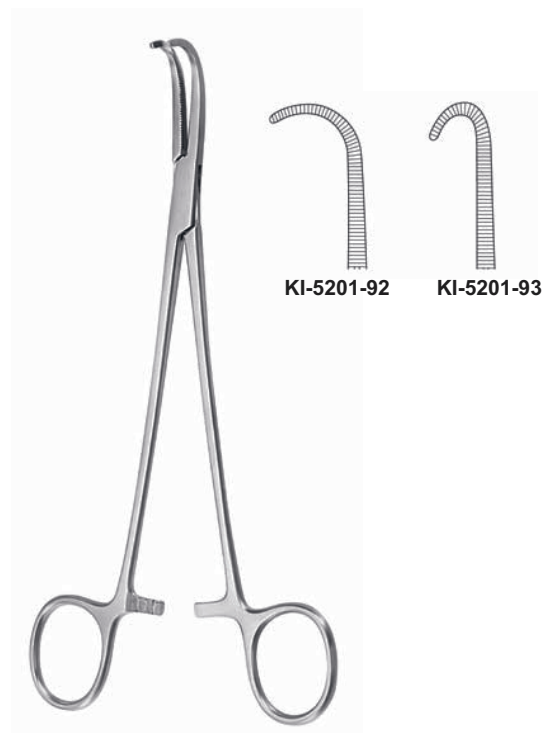

**NEGUS**  
19,0 cm, 7<sup>1</sup>/<sub>2</sub>"

Präparier- und Ligaturklemmen  
 Dissecting and Ligature Forceps  
 Pinzas de disección y ligaduras  
 Pinze per preparazioni e legature



14,0 cm, 5½"  
 KI-5201-94

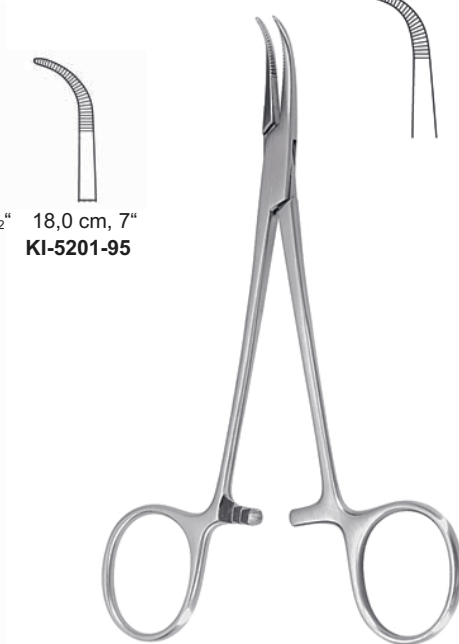

18,0 cm, 7"  
 KI-5201-95



**BABY-MIXTER**  
 18,0 cm, 7"  
 KI-5201-97



**OVERHOLT-MIXTER**  
 21,0 cm, 8¼"  
 KI-5201-98



**JOHNS HOPKINS**  
 20,0 cm, 8"  
 KI-5201-99

Präparier- und Ligaturklemmen  
 Dissecting and Ligature Forceps  
 Pinzas de disección y ligaduras  
 Pinze per preparazioni e legature



**OVERHOLT**

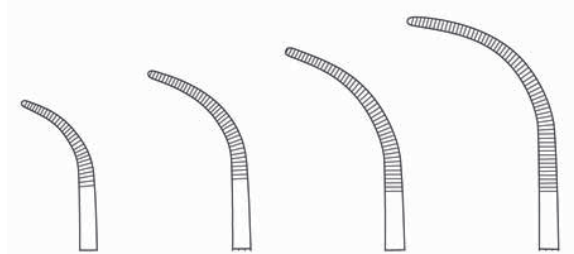

18,5 cm, 7<sup>1</sup>/<sub>4</sub>"    20,0 cm, 8"  
**KI-5301-01**    **KI-5301-02**    21,0 cm, 8<sup>1</sup>/<sub>4</sub>"    21,5 cm, 8<sup>1</sup>/<sub>2</sub>"  
**KI-5301-03**    **KI-5301-04**



**RUMEL**  
 23,0 cm, 9"

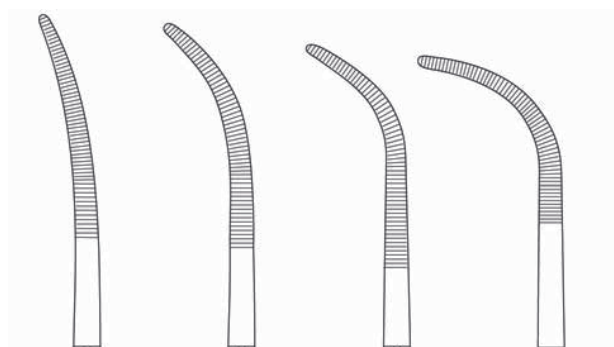

**KI-5301-05**    **KI-5301-06**    **KI-5301-07**    **KI-5301-08**

Präparier- und Ligaturklemmen  
 Dissecting and Ligature Forceps  
 Pinzas de disección y ligaduras  
 Pinze per preparazioni e legature



**OVERHOLT-GEISSENDOERFER**

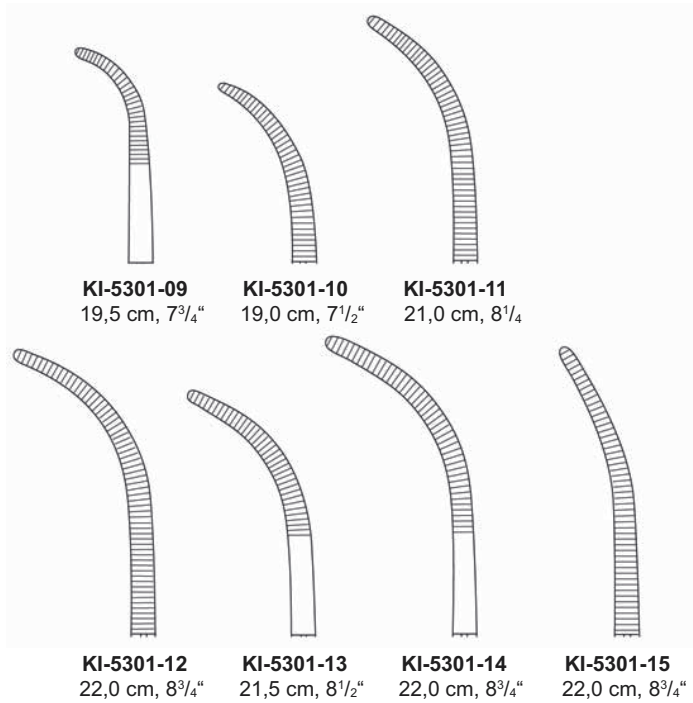

**OVERHOLT-GEISSENDOERFER**

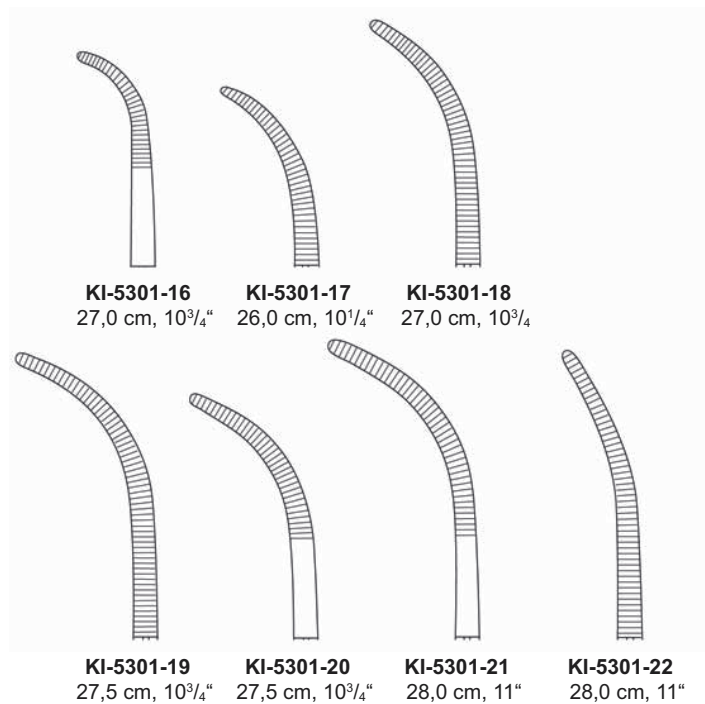

Präparier- und Ligaturklemmen  
 Dissecting and Ligature Forceps  
 Pinzas de disección y ligaduras  
 Pinze per preparazioni e legature

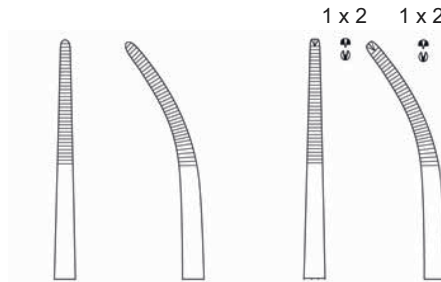

21,0 cm, 8 <sup>1</sup> / <sub>4</sub> "	KI-5301-23	KI-5301-24	KI-5301-25	KI-5301-26
26,0 cm, 10 <sup>1</sup> / <sub>4</sub> "	KI-5301-27	KI-5301-28	KI-5301-29	KI-5301-30

TOENNIS

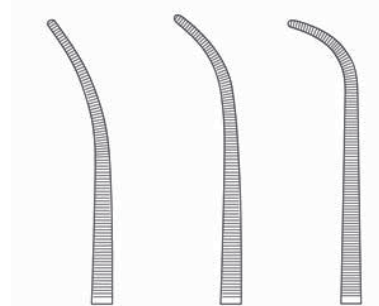

19,0 cm, 7 <sup>1</sup> / <sub>2</sub> "	KI-5301-31	KI-5301-32	KI-5301-33
22,0 cm, 8 <sup>5</sup> / <sub>8</sub> "	KI-5301-34	KI-5301-35	KI-5301-36
24,0 cm, 9 <sup>1</sup> / <sub>2</sub> "	KI-5301-37	KI-5301-38	KI-5301-39

KELLY

Präparier- und Ligaturklemmen  
 Dissecting and Ligature Forceps  
 Pinzas de disección y ligaduras  
 Pinze per preparazioni e legature



**MINI-GEMINI**

18,0 cm, 7"	<b>KI-5301-40</b>
22,0 cm, 8 <sup>5</sup> / <sub>8</sub> "	<b>KI-5301-41</b>
25,0 cm, 9 <sup>3</sup> / <sub>4</sub> "	<b>KI-5301-42</b>
28,0 cm, 11"	<b>KI-5301-43</b>

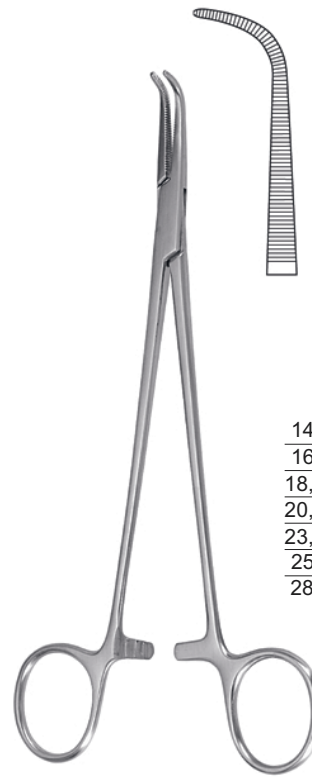

**GEMINI**

14,0 cm, 5 <sup>1</sup> / <sub>2</sub> "	<b>KI-5301-44</b>
16,0 cm, 6 <sup>1</sup> / <sub>4</sub> "	<b>KI-5301-45</b>
18,0 cm, 7"	<b>KI-5301-46</b>
20,0 cm, 8"	<b>KI-5301-47</b>
23,0 cm, 9"	<b>KI-5301-48</b>
25,0 cm, 9 <sup>3</sup> / <sub>4</sub> "	<b>KI-5301-49</b>
28,0 cm, 11"	<b>KI-5301-50</b>

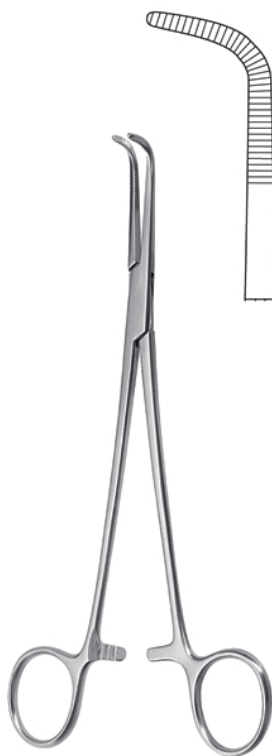

**KANTROWITZ**

20,0 cm, 8"	<b>KI-5301-51</b>
24,0 cm, 9 <sup>1</sup> / <sub>2</sub> "	<b>KI-5301-52</b>
28,0 cm, 11"	<b>KI-5301-53</b>



**WIKSTROEM**

19,0 cm, 7 <sup>1</sup> / <sub>2</sub> "	<b>KI-5301-54</b>
21,0 cm, 8 <sup>1</sup> / <sub>4</sub> "	<b>KI-5301-55</b>
24,0 cm, 9 <sup>1</sup> / <sub>2</sub> "	<b>KI-5301-56</b>

Präparier- und Ligaturklemmen  
 Dissecting and Ligature Forceps  
 Pinzas de disección y ligaduras  
 Pinze per preparazioni e legature



**MIXTER**  
 15,5 cm, 6" **KI-5301-57**  
 19,0 cm, 7½" **KI-5301-58**



**MIXTER-O'SHAUGNESSY**  
 15,5 cm, 6" **KI-5301-59**  
 19,0 cm, 7½" **KI-5301-60**



**MIXTER**  
 22,0 cm, 8¾" **KI-5301-61**



**MIXTER**  
 23,0 cm, 9" **KI-5301-62**

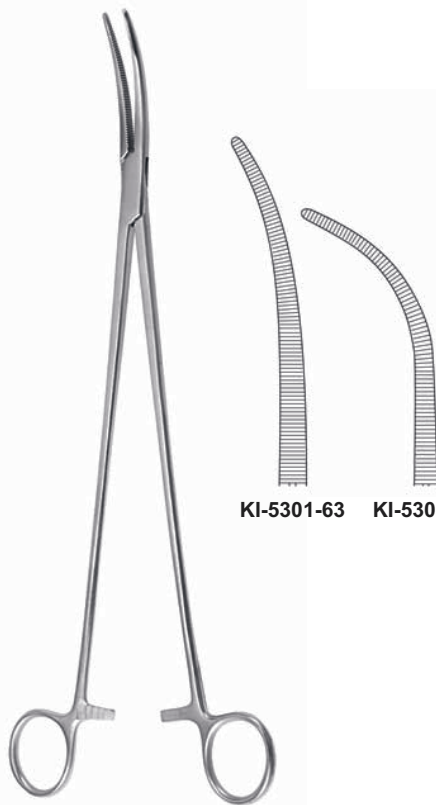

**ZENKER**

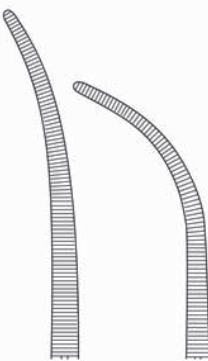

**KI-5301-63** **KI-5301-64**



**ZENKER**

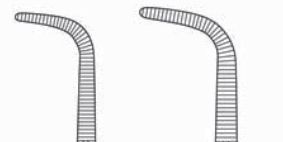

**KI-5301-65** **KI-5301-66**



Präparier- und Ligaturklemmen  
 Dissecting and Ligature Forceps  
 Pinzas de disección y ligaduras  
 Pinze per preparazioni e legature



**LAWRENCE**  
 27,5 cm, 10<sup>3</sup>/<sub>4</sub>"  
 KI-5301-67



**HOSEMANN**  
 21,0 cm, 8<sup>1</sup>/<sub>4</sub>"

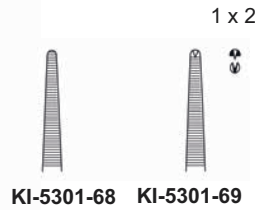

**DESJARDINS**  
 21,0 cm, 8<sup>1</sup>/<sub>4</sub>"  
 KI-5301-70

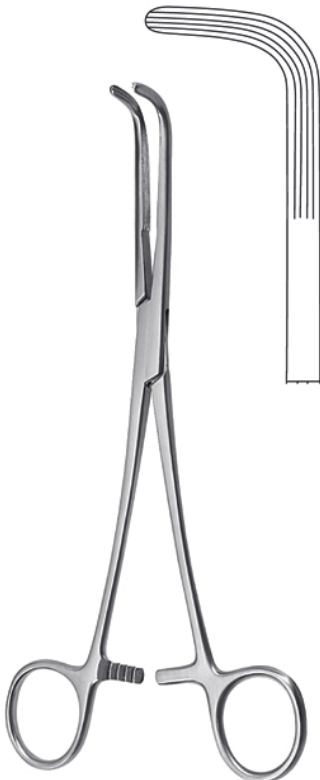

**MIXTER**  
 22,0 cm, 8<sup>3</sup>/<sub>4</sub>" KI-5301-71  
 25,0 cm, 9<sup>3</sup>/<sub>4</sub>" KI-5301-72  
 28,0 cm, 11" KI-5301-73

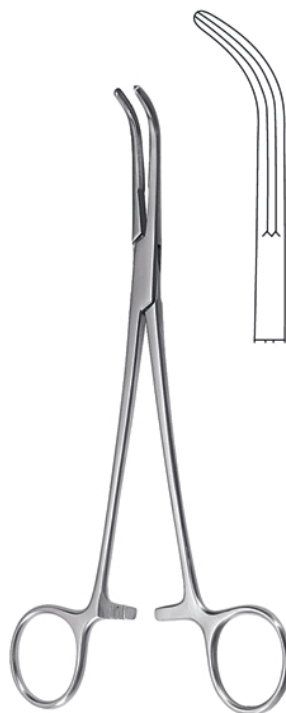

**LAHEY**  
 19,0 cm, 7<sup>1</sup>/<sub>2</sub>" KI-5301-74  
 23,0 cm, 9" KI-5301-75



18,0 cm, 7"  
 KI-5301-76

Präparier- und Ligaturklemmen  
 Dissecting and Ligature Forceps  
 Pinzas de disección y ligaduras  
 Pinze per preparazioni e legature

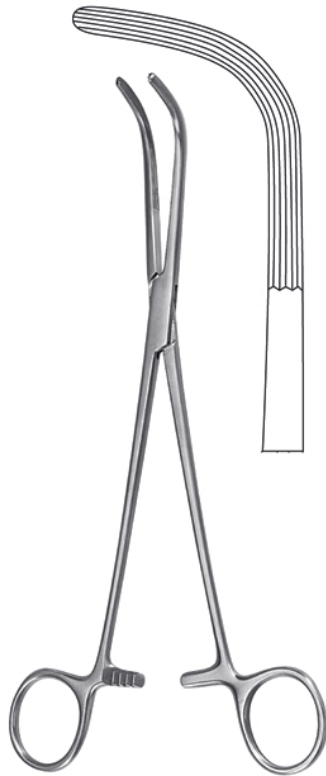

**MC QUIGG-MIXTER**  
 22,0 cm, 8<sup>3</sup>/<sub>4</sub>"  
 KI-5301-77

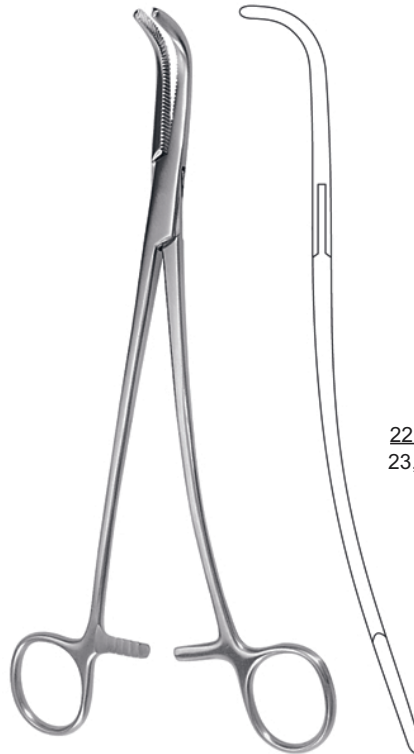

**GRAY**

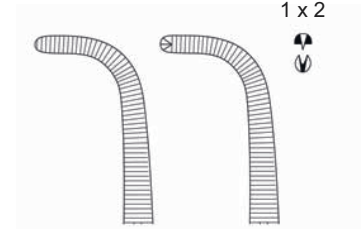

22,0 cm, 8<sup>3</sup>/<sub>4</sub>"    **KI-5301-78** **KI-5301-79**  
 23,0 cm, 9"    **KI-5301-80** **KI-5301-81**



**CRAFOORD-SELLORS**

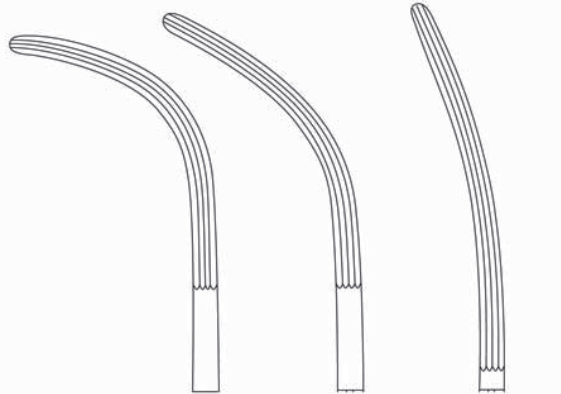

22,0 cm, 8<sup>3</sup>/<sub>4</sub>"    **KI-5301-82**  
 23,0 cm, 9"    **KI-5301-83**  
 24,0 cm, 9<sup>1</sup>/<sub>2</sub>"    **KI-5301-84**

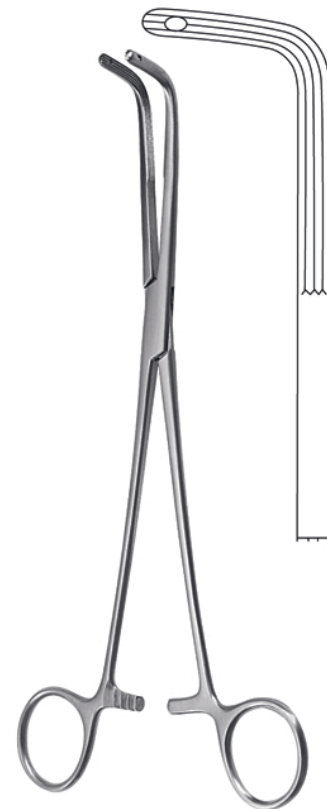

**FINOCCHIETTO**  
 24,0 cm, 9<sup>1</sup>/<sub>2</sub>"  
 KI-5301-85

Gallenkanal- und Nierenstielklemmen  
 Gall Duct and Kidney Pedicle Clamps  
 Pinzas-clamps para pedúnculo renal  
 Pinze per peduncoli renali

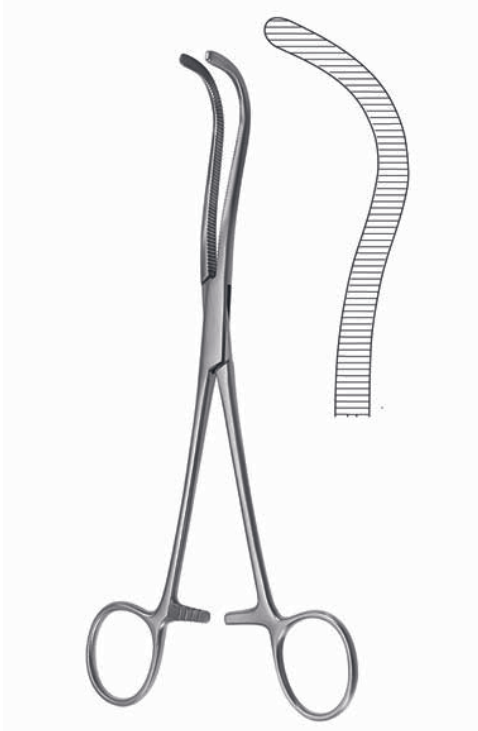

**GUYON**

20,0 cm, 8"	<b>KI-5301-86</b>
22,0 cm, 8 <sup>3</sup> / <sub>4</sub> "	<b>KI-5301-87</b>
24,0 cm, 9 <sup>1</sup> / <sub>2</sub> "	<b>KI-5301-88</b>

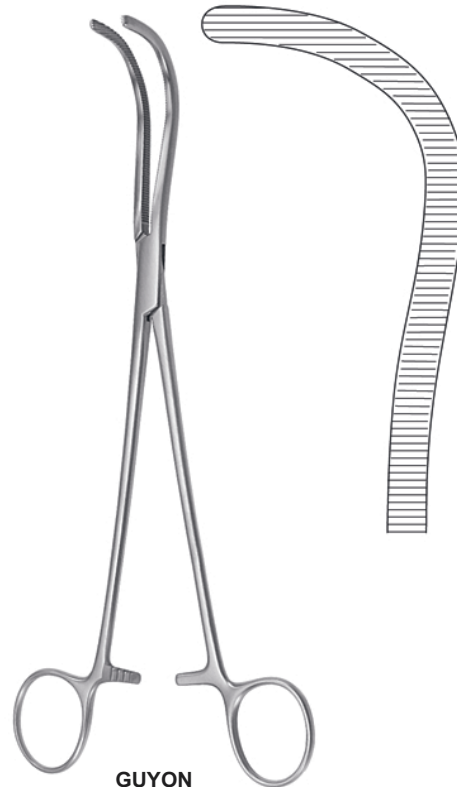

**GUYON**

23,0 cm, 9"  
**KI-5301-89**



23,0 cm, 9"  
**KI-5301-90**

24,0 cm, 9<sup>1</sup>/<sub>2</sub>"  
**KI-5301-91**

**GUYON**

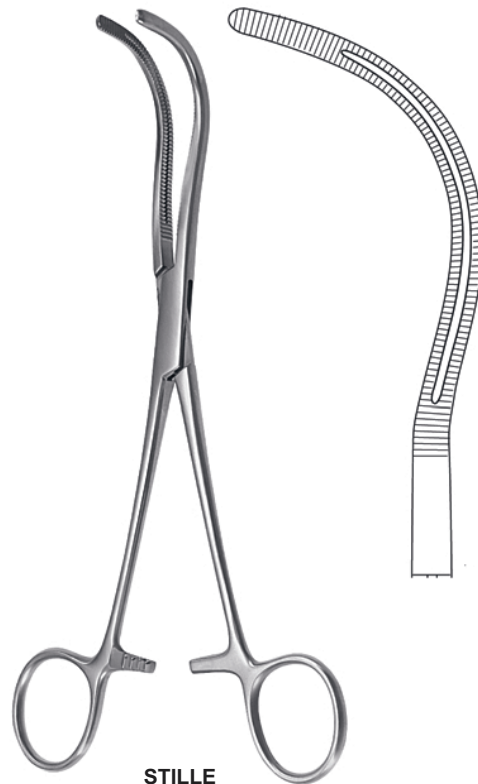

**STILLE**  
 23,0 cm, 9"  
**KI-5301-92**

Gallenkanal- und Nierenstielklemmen, Bronchusklemmen  
 Gall Duct and Kidney Pedicle Clamps, Bronchus Forceps  
 Pinzas-clamps para pedúnculo renal, Pinzas-clamps para bronquios  
 Pinze per peduncoli renali, Pinze per legature

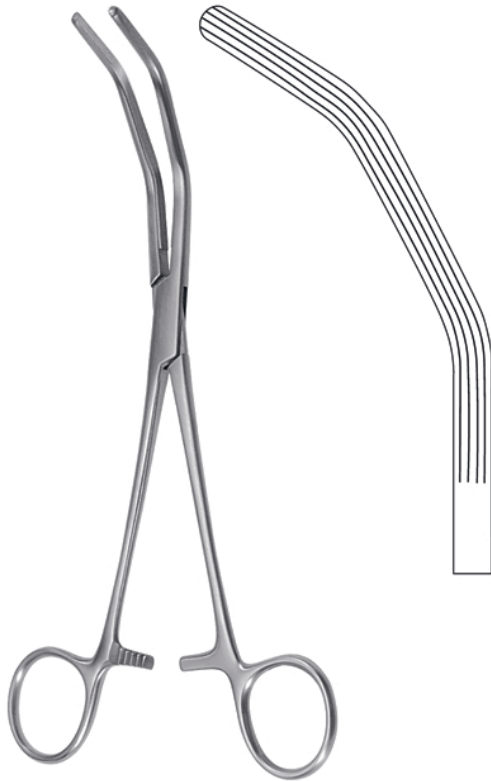

**HERRICK**  
 23,0 cm, 9"  
 KI-5301-93

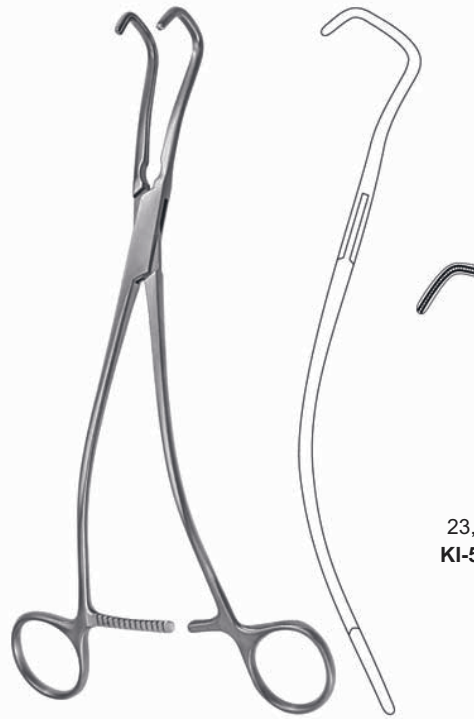

**URO-TANGENTIAL**  
 26,0 cm, 10 1/4"



23,0 cm, 9"  
 KI-5301-94

24,0 cm, 9 1/2"  
 KI-5301-95



**LOVELACE**  
 20,0 cm, 8"  
 KI-5301-96



**LOVELACE**  
 20,0 cm, 8"  
 KI-5301-97



**PRICE-THOMAS**  
 22,0 cm, 8 3/4"  
 KI-5301-98

Bronchusklemmen, Peritoneumklemmen, Hysterektomieklemmen  
 Bronchus Forceps, Peritoneum Forceps, Hysterectomy Forceps  
 Pinzas-clamps para bronquios, Pinzas-clamps para peritoneo y para histerectomía  
 Pinze per legature, Pinze per peritoneo e per isterectomia



**PRICE-THOMAS**  
 22,0 cm, 8<sup>3</sup>/<sub>4</sub>"

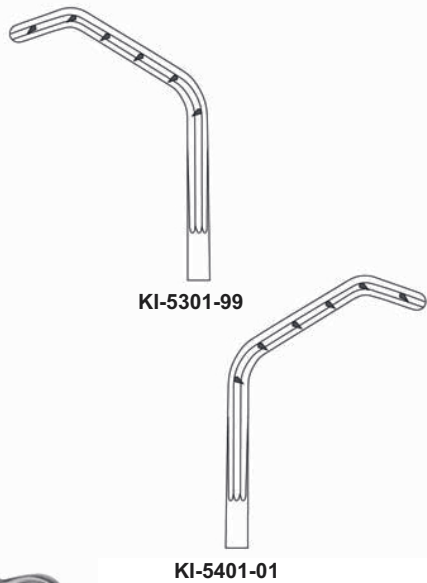

KI-5301-99

KI-5401-01



KI-5401-02

KI-5401-03

24,0 cm, 9<sup>1</sup>/<sub>2</sub>"

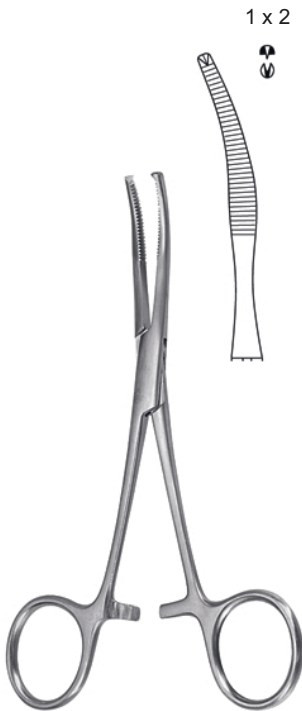

**BABY-MIKULICZ**  
 14,0 cm, 5<sup>1</sup>/<sub>2</sub>"  
 KI-5401-04

1 x 2  



**MIKULICZ**  
 18,0 cm, 7"  
 KI-5401-05

1 x 2  

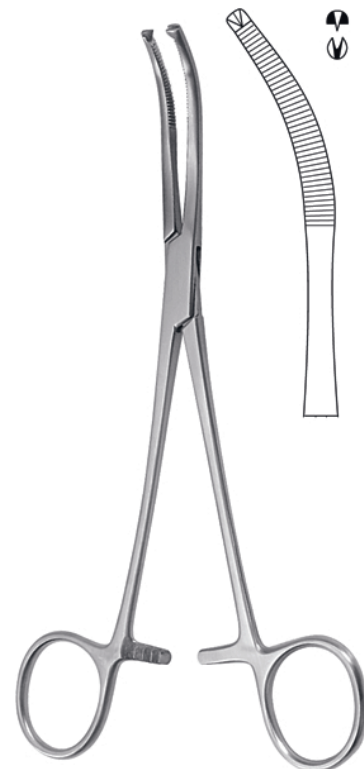
**MIKULICZ**  
 20,0 cm, 8"  
 KI-5401-06

1 x 2  



Peritoneumklemmen, Hysterektomieklemmen  
 Peritoneum Forceps, Hysterectomy Forceps  
 Pinzas-clamps para peritoneo y para histerectomia  
 Pinze per peritoneo e per isterectomia

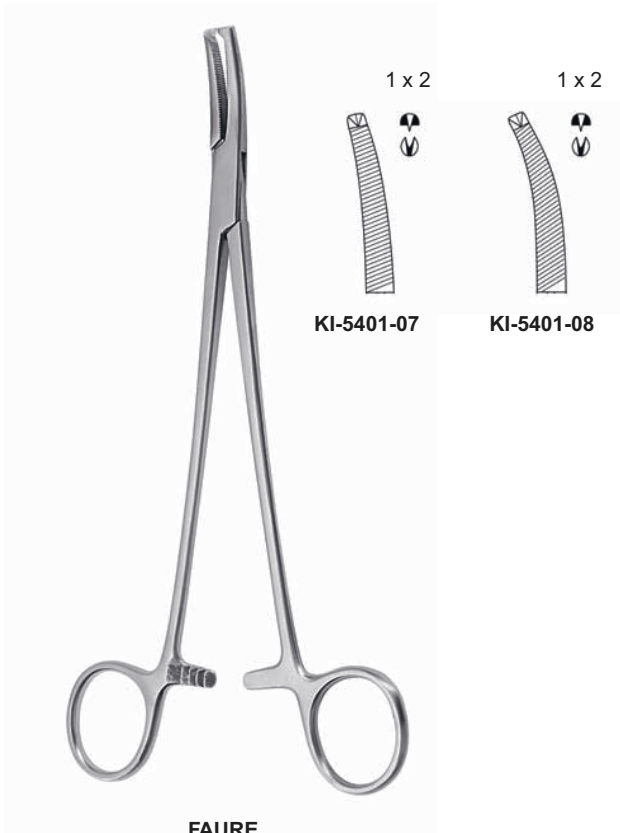

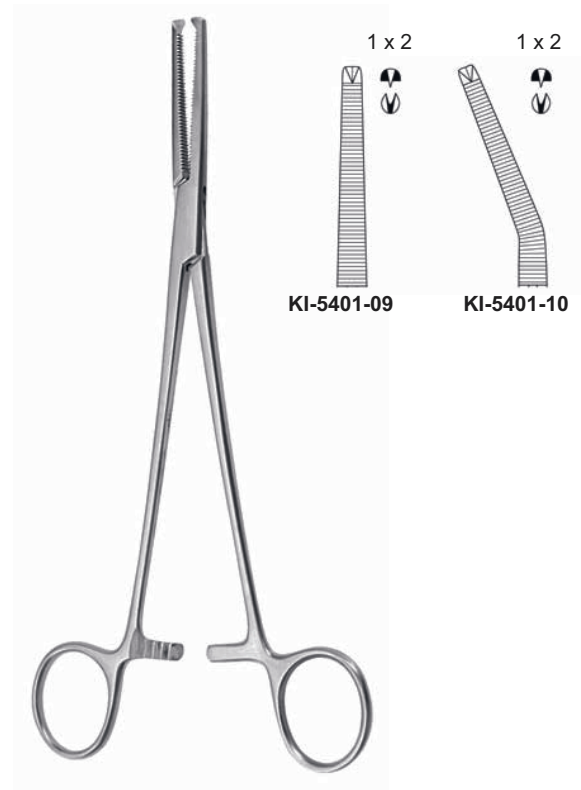
**FAURE**  
 20,0 cm, 8"

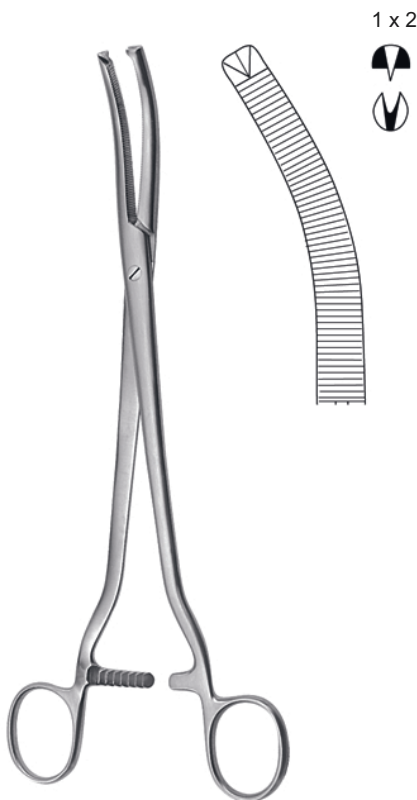

**PHANEUF**  
 21,5 cm, 8 1/2"



**WERTHEIM**  
 24,0 cm, 9 1/2"  
 KI-5401-11



**WERTHEIM**  
 25,0 cm, 10"  
 KI-5401-12

Hysterektomieklemmen  
 Hysterectomy Forceps  
 Pinzas-clamps para histerectomia  
 Pinze per isterectomia

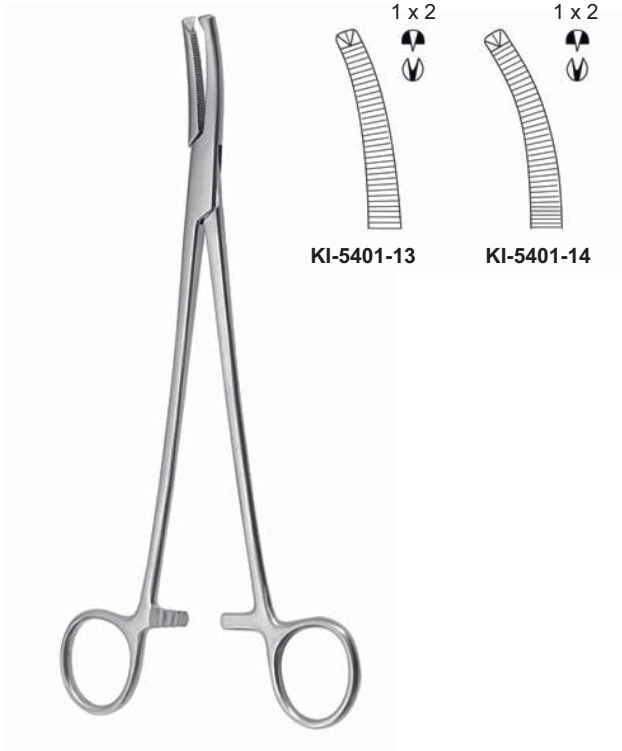

**WERTHEIM**  
 23,0 cm, 9"

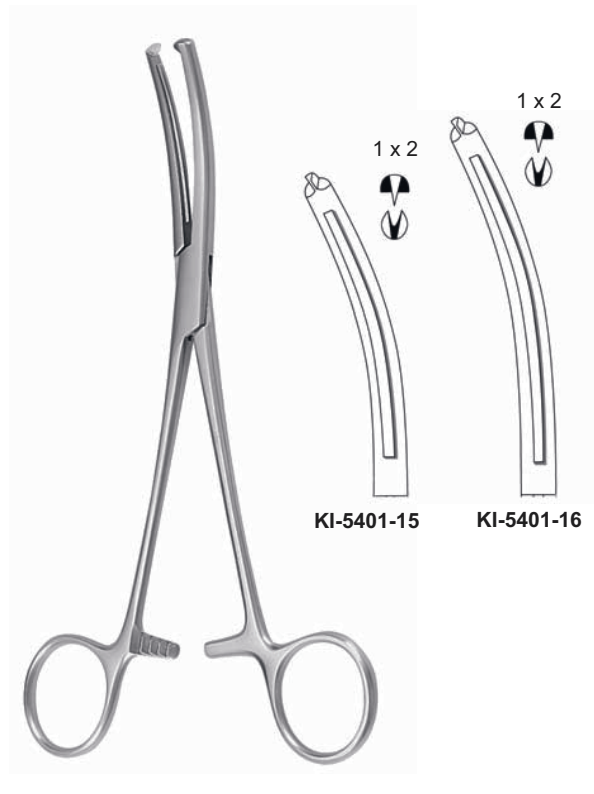

**MAINGOT**  
 21,5 cm, 8 1/2"

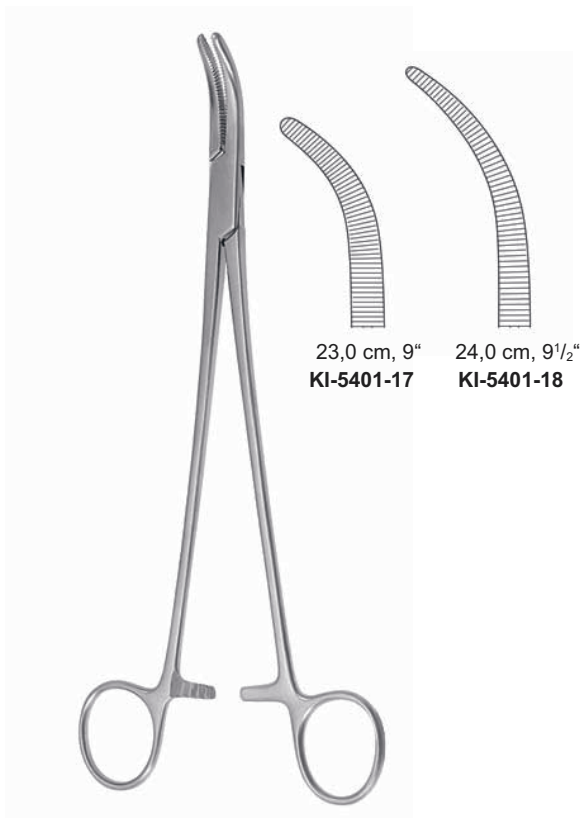

**MOYNIHAN**



**WERTHEIM-CULLEN**  
 21,5 cm, 8 1/2"  
 KI-5401-19

Hysterektomieklemmen  
 Hysterectomy Forceps  
 Pinzas-clamps para histerectomia  
 Pinze per isterectomia

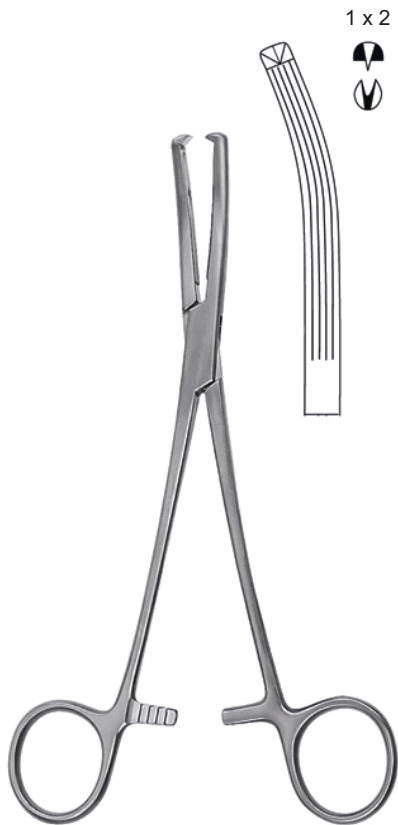

**LONG**  
 19,0 cm, 7<sup>1</sup>/<sub>4</sub>"  
 KI-5401-20

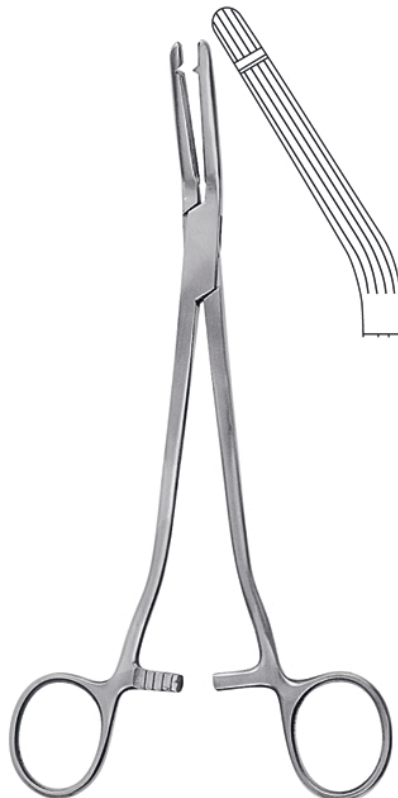

**GARLAND**  
 21,0 cm, 8<sup>1</sup>/<sub>4</sub>"  
 KI-5401-21



**HEANEY**  
 21,0 cm, 8<sup>1</sup>/<sub>4</sub>"  
 KI-5401-22

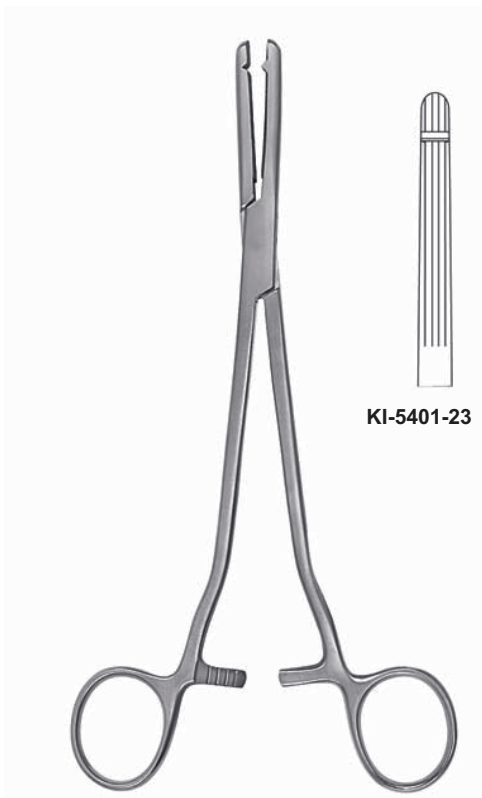

**HEANEY-BALLANTINE**  
 21,0 cm, 8<sup>1</sup>/<sub>4</sub>"



KI-5401-23

KI-5401-24

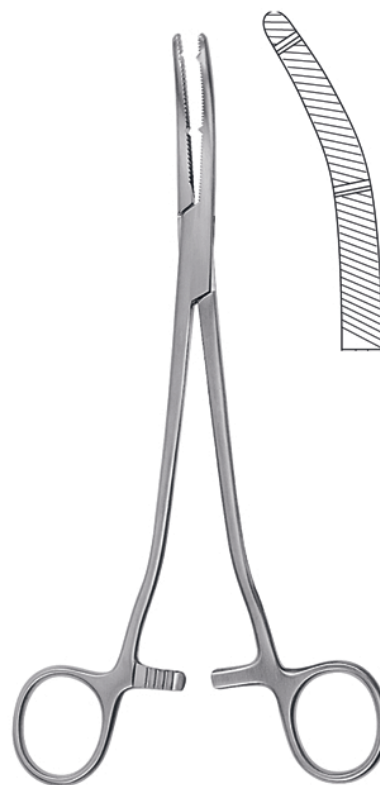

**HEANEY-KANTER**  
 21,0 cm, 8<sup>1</sup>/<sub>4</sub>"  
 KI-5401-25



Hysterektomieklemmen  
Hysterectomy Forceps  
Pinzas-clamps para histerectomia  
Pinze per isterectomia

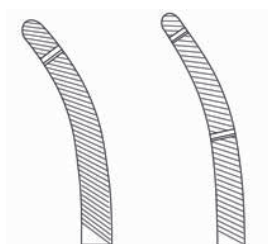

21,0 cm, 8 $\frac{1}{4}$ "	<b>KI-5401-26</b>	<b>KI-5401-27</b>
23,0 cm, 9"	<b>KI-5401-28</b>	<b>KI-5401-29</b>



“Supporting Healthcare”

**KAAHA INDUSTRIES**

Manufacturer Of Dental & Surgical Instruments

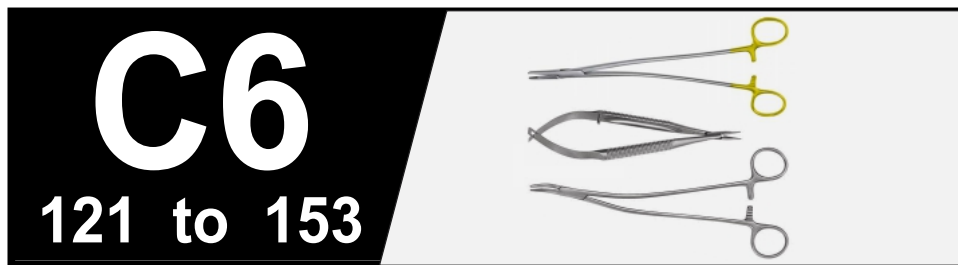

**Nahtinstrumente**

**Suture Instruments**

**Instrumentos para sutura**

**strumenti per sutura**

Nadelhalter  
 Needle Holders  
 Porta-agujas  
 Portaghi



**KI-6401-01**  
 12,0 cm, 4<sup>3</sup>/<sub>4</sub>"

**DERF**



**KI-6401-02**  
 12,5 cm, 5"



**COLLIER**  
 12,5 cm, 5"  
**KI-6401-03**



**WEBSTER**  
 13,0 cm, 5"  
**KI-6401-04**



**HALSEY**  
 13,0 cm, 5"

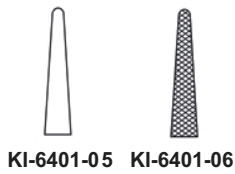

**KI-6401-05** **KI-6401-06**



**NEIVERT**  
 13,0 cm, 5"  
**KI-6401-07**



**HEGAR-BAUMGARTNER**  
 14,0 cm, 5<sup>1</sup>/<sub>2</sub>"  
**KI-6401-08**

Nadelhalter  
Needle Holders  
Porta-agujas  
Portaghi



KI-6401-09  
13,0 cm, 5"

**BROWN**



**CRILE-MURRAY**  
15,0 cm, 6"  
KI-6401-10



KI-6401-11  
15,0 cm, 6"

**CRILE-WOOD**



**ADSON**  
18,0 cm, 7"  
KI-6401-12



**METZENBAUM**  
18,0 cm, 7"  
KI-6401-13



**MASS.-GENERAL-HOSPITAL**  
17,0 cm, 6<sup>3</sup>/<sub>4</sub>"  
KI-6401-14

# General Surgery Instruments



"Supporting Healthcare"  
**KAHA INDUSTRIES**  
 Manufacturer Of Dental & Surgical Instruments

Nadelhalter  
 Needle Holders  
 Porta-agujas  
 Portaghi



**MAYO-HEGAR**



**KI-6401-15**

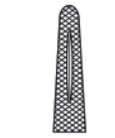

**KI-6401-16**

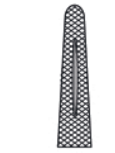

**KI-6401-17**



**KI-6401-18**

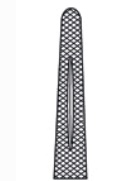

**KI-6401-19**

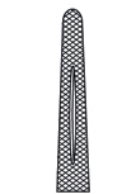

**KI-6401-20**



**KI-6401-21**



**MAYO-HEGAR-DELICATE**



**KI-6401-22**  
 16,0 cm, 6<sup>1</sup>/<sub>4</sub>"



**KI-6401-23**  
 18,0 cm, 7"



**KI-6401-24**  
 20,0 cm, 8"



**LAWRENCE**  
 15,0 cm, 6"  
**KI-6401-26**

Nadelhalter  
 Needle Holders  
 Porta-agujas  
 Portaghi



**HEANEY**

21,0 cm, 8<sup>1</sup>/<sub>4</sub>"  
 KI-6401-27



**JAMISON**

23,5 cm, 9<sup>1</sup>/<sub>4</sub>"  
 KI-6401-28



**MASSON**

27,0 cm, 10<sup>1</sup>/<sub>2</sub>"  
 KI-6401-29



**FINOCCHIETTO**  
 27,0 cm, 10<sup>1</sup>/<sub>2</sub>"  
 KI-6401-30



**WANGENSTEEN**  
 27,0 cm, 10<sup>1</sup>/<sub>2</sub>"  
 KI-6401-31



**JOHNSON**  
 27,0 cm, 10<sup>1</sup>/<sub>2</sub>"  
 KI-6401-32

Nadelhalter  
 Needle Holders  
 Porta-agujas  
 Portaghi

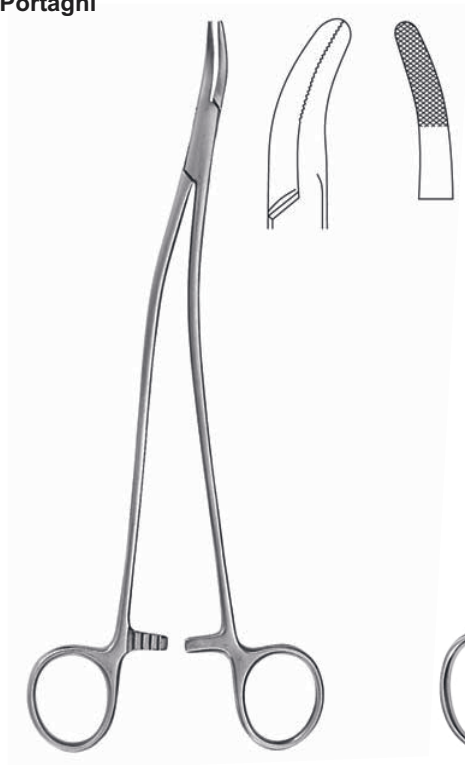

**STRATTE**  
 23,0 cm, 9"  
 KI-6401-33



**OLSEN-HEGAR**  
 17,0 cm, 6<sup>3</sup>/<sub>4</sub>"  
 KI-6401-34

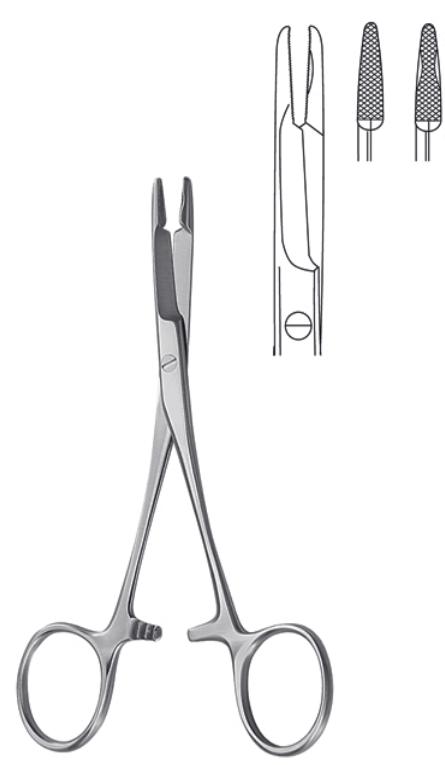

**OLSEN-HEGAR**  
 14,0 cm, 5<sup>1</sup>/<sub>2</sub>"  
 KI-6401-35



**OLSEN-HEGAR**

14,0 cm, 5<sup>1</sup>/<sub>2</sub>"  
 KI-6401-36

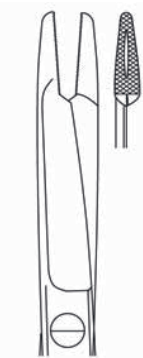

18,0 cm, 7"  
 KI-6401-37



**TOENNIS**  
 18,0 cm, 7"  
 KI-6401-38

Nadelhalter  
 Needle Holders  
 Porta-agujas  
 Portaghi



**KI-6401-39**  
 14,0 cm, 5½"



**KI-6401-40**  
 17,0 cm, 6¾"



**KI-6401-41**  
 20,0 cm, 8"



**KI-6401-42**  
 17,0 cm, 6¾"

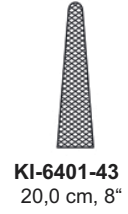

**KI-6401-43**  
 20,0 cm, 8"



**LICHTENBERG**  
 20,0 cm, 8"  
**KI-6401-44**



**MATHIEU**



**KI-6401-44**  
 14,0 cm, 5½"

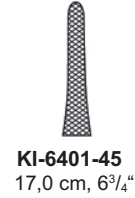

**KI-6401-45**  
 17,0 cm, 6¾"





Nadelhalter, Mikro-Nadelhalter  
 Needle Holders, Micro Needle Holders  
 Porta-agujas, Micro Porta-agujas  
 Portaghi, Micro Portaghi



**MATHIEU-KOCHER**



**KI-6401-46**  
 14,0 cm, 5 1/2"



**KI-6401-47**  
 17,0 cm, 6 3/4"



**KI-6401-48**  
 20,0 cm, 8"



**KI-6401-49**



**KI-6401-50**



**BARRAQUER-TROUTMAN**  
 10,0 cm, 4"



**BARRAQUER**



**KI-6401-51**



**KI-6401-52**



**BARRAQUER**  
 13,5 cm, 5 3/8"  
**KI-6401-53**



**GOMEL**  
 14,0 cm, 5 1/2"  
**KI-6401-54**



**Mikro-Nadelhalter**  
**Micro Needle Holders**  
**Micro Porta-agujas**  
**Micro Portaghi**



ohne Sperre  
 without ratchet  
 sin cremallera  
 senza cremagliera

18,5 cm, 7<sup>1</sup>/<sub>4</sub>"

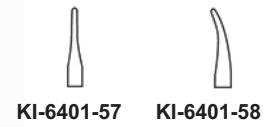

mit Sperre  
 with ratchet  
 con cremallera  
 con cremagliera

18,5 cm, 7<sup>1</sup>/<sub>4</sub>"

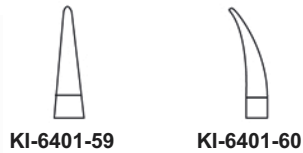

mit Sperre  
 with ratchet  
 con cremallera  
 con cremagliera

**CASTROVIEJO**  
 14,5 cm, 5<sup>3</sup>/<sub>4</sub>"

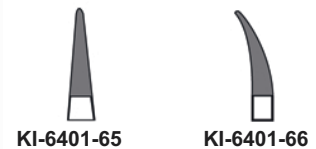

mit Sperre  
 with ratchet  
 con cremallera  
 con cremagliera

**CASTROVIEJO**  
 18,0 cm, 7"

**Mikro-Nadelhalter**  
**Micro Needle Holders**  
**Micro Porta-agujas**  
**Micro Portaghi**

0,4 mm



gerade, ohne Sperre  
 straight, without ratchet  
 recta, sin cremallera  
 retta, senza cremagliera

14,0 cm, 5 1/2"  
**KI-6401-67**

0,4 mm



gebogen, ohne Sperre  
 curved, without ratchet  
 curva, sin cremallera  
 curva, senza cremagliera

14,0 cm, 5 1/2"  
**KI-6401-68**

0,4 mm



14,0 cm, 5 1/2"  
**KI-6401-69**

0,5 mm



gebogen, ohne Sperre  
 curved, without ratchet  
 curva, sin cremallera  
 curva, senza cremagliera

Ø 10 mm

14,0 cm, 5 1/2"  
**KI-6401-70**

0,5 mm



gebogen, ohne Sperre  
 curved, without ratchet  
 curva, sin cremallera  
 curva, senza cremagliera

Ø 10 mm

14,0 cm, 5 1/2"  
**KI-6401-71**

0,4 mm



gebogen, ohne Sperre  
 curved, without ratchet  
 curva, sin cremallera  
 curva, senza cremagliera

Ø 8 mm

13,0 cm, 5"  
**KI-6401-72**

0,4 mm



gebogen, ohne Sperre  
 curved, without ratchet  
 curva, sin cremallera  
 curva, senza cremagliera

Ø 8 mm

13,0 cm, 5"  
**KI-6401-73**

Nadelhalter mit Hartmetalleinlagen  
 Needle Holders with tungsten carbide inserts  
 Porta-agujas con bocas de carburo tungsteno  
 Portaghi con morsi in carburo di tungsteno



**KALT**  
 13,5 cm, 5<sup>3</sup>/<sub>8</sub>"  
 KI-6401-74



**DIETHRICH**

- |   |                   |
|---|-------------------|
| 16,0 cm, 5 <sup>3</sup> / <sub>8</sub> "  | <b>KI-6401-75</b> |
| 18,0 cm, 7"                               | <b>KI-6401-76</b> |
| 20,0 cm, 8"                               | <b>KI-6401-77</b> |
| 23,0 cm, 9"                               | <b>KI-6401-78</b> |
| 26,0 cm, 10 <sup>1</sup> / <sub>4</sub> " | <b>KI-6401-79</b> |



**WEBSTER**  
 13,0 cm, 5"  
 KI-6401-80



**DERF**  
 12,0 cm, 4<sup>3</sup>/<sub>4</sub>"  
 KI-6401-81



**HEGAR-BAUMGARTNER**

**KI-6401-82**  
 12,5 cm, 5"

**KI-6401-83**  
 14,0 cm, 5<sup>1</sup>/<sub>2</sub>"



**WEBSTER**  
 13,0 cm, 5"  
 KI-6401-84

Nadelhalter mit Hartmetalleinlagen  
 Needle Holders with tungsten carbide inserts  
 Porta-agujas con bocas de carburo tungsteno  
 Portaghi con morsi in carburo di tungsteno



**HALSEY**  
 13,0 cm, 5"

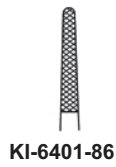

**CRILE-WOOD**



**SAROT**



Nadelhalter mit Hartmetalleinlagen  
 Needle Holders with tungsten carbide inserts  
 Porta-agujas con bocas de carburo tungsteno  
 Portaghi con morsi in carburo di tungsteno



**KI-6401-92**  
 16,0 cm, 6 1/4"

**KI-6401-93**  
 18,0 cm, 7"

**KI-6401-94**  
 20,0 cm, 8"

**KI-6401-95**  
 24,0 cm, 9 1/2"

**KI-6401-96**  
 26,0 cm, 10 1/4"

**KI-6401-97**  
 30,0 cm, 12"

**MAYO-HEGAR**



**MAYO-HEGAR (HEANEY)**

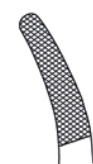

**KI-6401-98**  
 20,0 cm, 8"



**KI-6401-99**  
 24,0 cm, 9 1/4"



**KI-6501-01**  
 26,0 cm, 10 1/4"

Nadelhalter mit Hartmetalleinlagen  
 Needle Holders with tungsten carbide inserts  
 Porta-agujas con bocas de carburo tungsteno  
 Portaghi con morsi in carburo di tungsteno

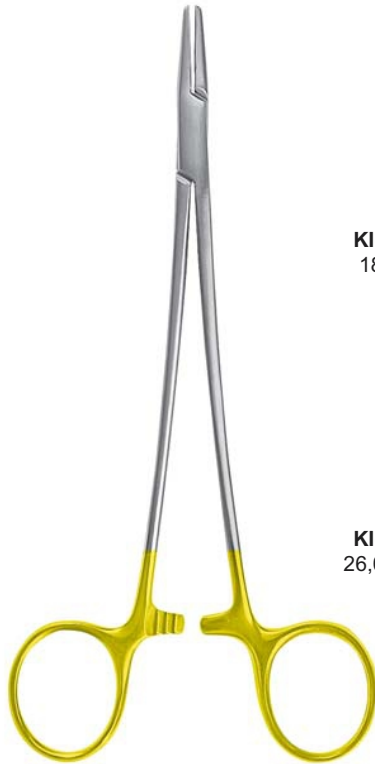

DE BAKEY



**KI-6501-02**  
18,0 cm, 7"



**KI-6501-03**  
20,0 cm, 8"



**KI-6501-04**  
23,0 cm, 9"



**KI-6501-05**  
26,0 cm, 10<sup>1</sup>/<sub>4</sub>"



**KI-6501-06**  
31,0 cm, 12<sup>1</sup>/<sub>4</sub>"



**KI-6501-07**  
37,0 cm, 14<sup>1</sup>/<sub>2</sub>"

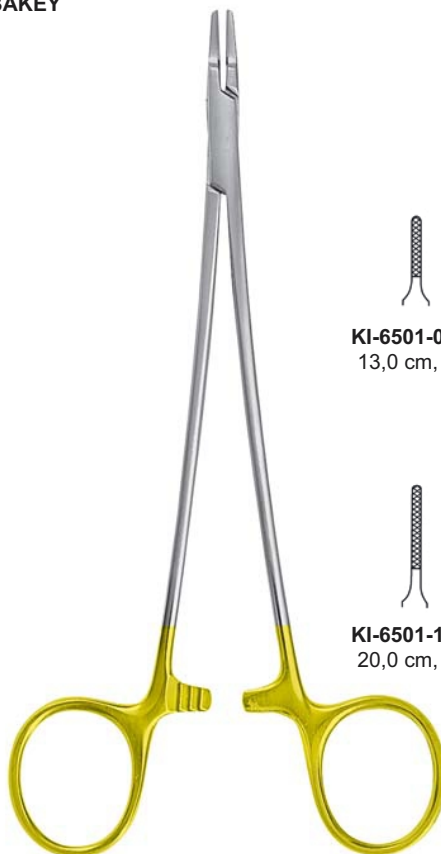

RYDER-VASCULAR



**KI-6501-08**  
13,0 cm, 5"



**KI-6501-09**  
15,0 cm, 6"

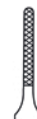

**KI-6501-10**  
18,0 cm, 7"



**KI-6501-11**  
20,0 cm, 8"

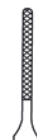

**KI-6501-12**  
23,0 cm, 9"



**KI-6501-13**  
26,0 cm, 10<sup>1</sup>/<sub>4</sub>"

Nadelhalter mit Hartmetalleinlagen  
Needle Holders with tungsten carbide inserts  
Porta-agujas con bocas de carburo tungsteno  
Portaghi con morsi in carburo di tungsteno



**RYDER**

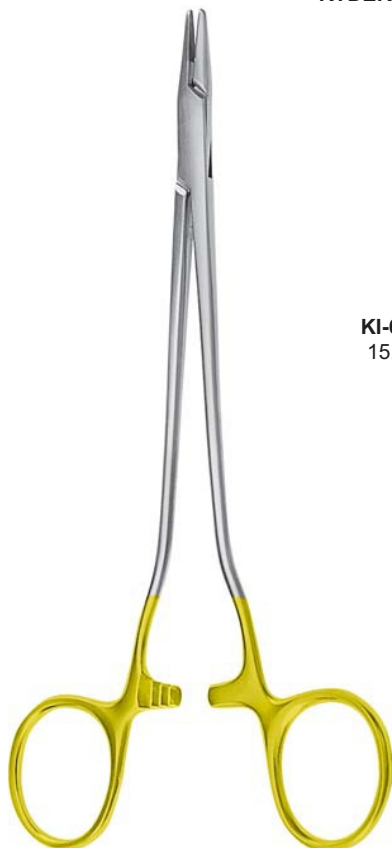
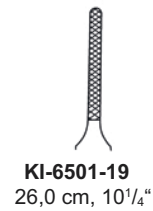
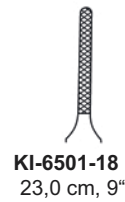

**SCHWEDISCHES MODELL**

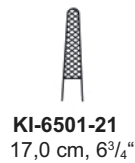
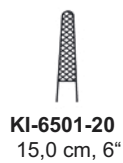



Nadelhalter mit Hartmetalleinlagen  
 Needle Holders with tungsten carbide inserts  
 Porta-agujas con bocas de carburo tungsteno  
 Portaghi con morsi in carburo di tungsteno

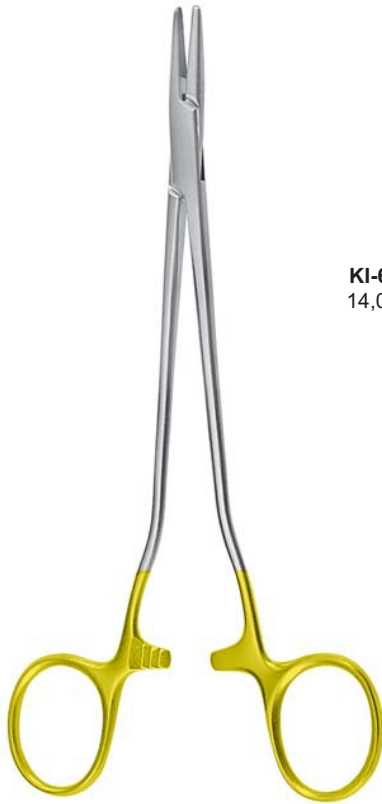

**MAYO-HEGAR (HEANEY)**



**KI-6501-23**  
 14,0 cm, 5½"



**KI-6501-24**  
 18,0 cm, 7"



**KI-6501-25**  
 20,0 cm, 8"



**KI-6501-26**  
 23,0 cm, 9"



**FINOCCHIETTO**  
 27,0 cm, 10½"  
 KI-6501-27



**MASSON**  
 27,0 cm, 10½"  
 KI-6501-28



**WANGENSTEEN**  
 27,0 cm, 10½"  
 KI-6501-29

Nadelhalter mit Hartmetalleinlagen  
 Needle Holders with tungsten carbide inserts  
 Porta-agujas con bocas de carburo tungsteno  
 Portaghi con morsi in carburo di tungsteno



**BOZEMANN**

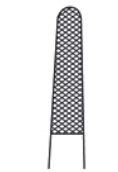

**KI-6501-30**  
 20,0 cm, 8"



**KI-6501-31**  
 24,0 cm, 9<sup>5</sup>/<sub>8</sub>"



**KI-6501-32**  
 26,0 cm, 10<sup>1</sup>/<sub>4</sub>"



**HEGAR**



**KI-6501-33**  
 20,0 cm, 8"



**KI-6501-34**  
 24,0 cm, 9<sup>5</sup>/<sub>8</sub>"



**BARRY STERNAL**



**KI-6501-35**  
 15,0 cm, 6"



**KI-6501-36**  
 20,0 cm, 8"

Nadelhalter mit Hartmetalleinlagen  
 Needle Holders with tungsten carbide inserts  
 Porta-agujas con bocas de carburo tungsteno  
 Portaghi con morsi in carburo di tungsteno



**STRATTE**

**KI-6501-37**  
 22,0 cm, 8<sup>5</sup>/<sub>8</sub>"

**KI-6501-38**  
 23,0 cm, 9"



**GILLIES**  
 16,0 cm, 6<sup>1</sup>/<sub>4</sub>"  
**KI-6501-39**



**OLSEN-HEGAR**

**KI-6501-40**  
 14,0 cm, 5<sup>1</sup>/<sub>2</sub>"

**KI-6501-41**  
 17,0 cm, 6<sup>3</sup>/<sub>4</sub>"

**KI-6501-42**  
 18,0 cm, 7"



**TOENNIS**  
 18,0 cm, 7"  
**KI-6501-43**

Nadelhalter mit Hartmetalleinlagen  
Needle Holders with tungsten carbide inserts  
Porta-agujas con bocas de carburo tungsteno  
Portaghi con morsi in carburo di tungsteno



MATHIEU-KOCHER



**KI-6501-44**  
14,0 cm, 5½"



**KI-6501-45**  
17,0 cm, 6¾"



**KI-6501-46**  
20,0 cm, 8"



MATHIEU



**KI-6501-47**  
14,0 cm, 5½"



**KI-6501-48**  
17,0 cm, 6¾"



**KI-6501-49**  
20,0 cm, 8"

Nadelhalter mit Hartmetalleinlagen  
Needle Holders with tungsten carbide inserts  
Porta-agujas con bocas de carburo tungsteno  
Portaghi con morsi in carburo di tungsteno



LICHTENBERG



KI-6501-50  
17,0 cm, 6<sup>3</sup>/<sub>4</sub>"



KI-6501-51  
20,0 cm, 8"



MATHIEU



KI-6501-52  
17,0 cm, 6<sup>3</sup>/<sub>4</sub>"



KI-6501-53  
20,0 cm, 8"



KI-6501-54  
23,0 cm, 9"

Nadelhalter mit Hartmetalleinlagen  
 Needle Holders with tungsten carbide inserts  
 Porta-agujas con bocas de carburo tungsteno  
 Portaghi con morsi in carburo di tungsteno



ZWEIFEL



KI-6501-55  
 20,0 cm, 8"



KI-6501-56  
 23,0 cm, 9"



LANGENBECK



KI-6501-57  
 18,0 cm, 7"



KI-6501-58  
 20,0 cm, 8"



KI-6501-59  
 23,0 cm, 9"



KI-6501-60  
 18,0 cm, 7"



KI-6501-61  
 20,0 cm, 8"



KI-6501-62  
 23,0 cm, 9"

Nadelhalter mit Hartmetalleinlagen  
 Needle Holders with tungsten carbide inserts  
 Porta-agujas con bocas de carburo tungsteno  
 Portaghi con morsi in carburo di tungsteno



KI-6501-63



KI-6501-64



KI-6501-65



KI-6501-66

mit Sperre  
 with ratchet  
 con cremallera  
 con cremagliera

**CASTROVIEJO**  
 14,5 cm, 5<sup>3</sup>/<sub>4</sub>"



KI-6501-67



KI-6501-68



KI-6501-69



KI-6501-70

mit Sperre  
 with ratchet  
 con cremallera  
 con cremagliera

**CASTROVIEJO**  
 18,0 cm, 7"



KI-6501-71



KI-6501-72



KI-6501-73



KI-6501-74

mit Sperre  
 with ratchet  
 con cremallera  
 con cremagliera

**BARRAQUER**  
 14,5 cm, 5<sup>3</sup>/<sub>4</sub>"



**HEPP SCHEIDEL**  
 18,0 cm, 7"  
 KI-6501-75

REVERDIN-Nadeln  
 REVERDIN Needles  
 Agujas de REVERDIN  
 Aghi di REVERDIN



**REVERDIN**  
 14,0 cm, 5 1/2"

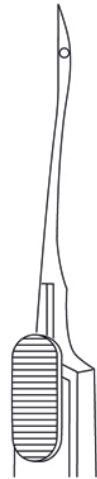

**KI-6501-76**



**KI-6501-77**



**KI-6501-78**



**KI-6501-79**



**REVERDIN**

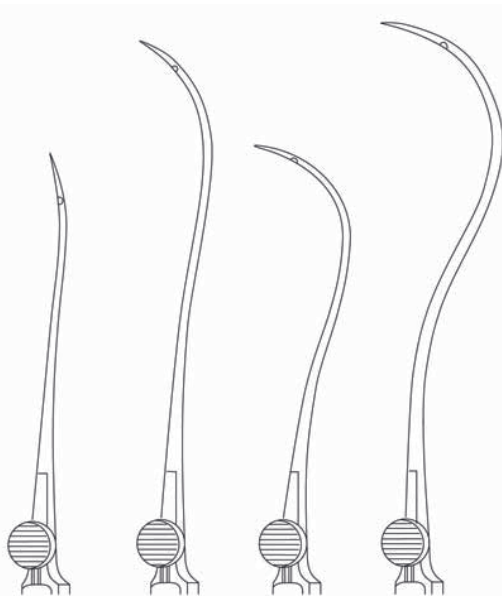

19,5 cm, 7 3/4" **KI-6501-80** **KI-6501-82** **KI-6501-84** **KI-6501-86**  
 22,5 cm, 8 3/4" **KI-6501-81** **KI-6501-83** **KI-6501-85** **KI-6501-87**



Unterbindungsnadeln  
 Ligature Needles  
 Agujas para ligaduras  
 Aghi per legatura

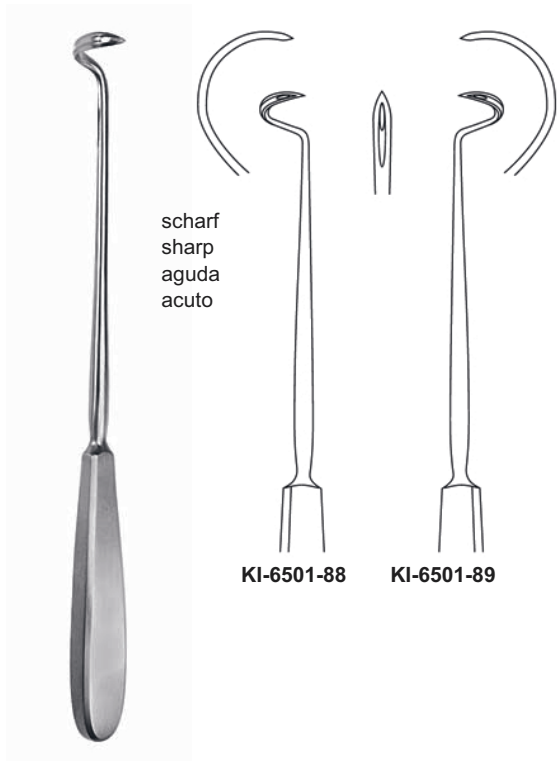

scharf  
 sharp  
 aguda  
 acuto

KI-6501-88

KI-6501-89

**DESCHAMPS**  
 20,0 cm, 8"

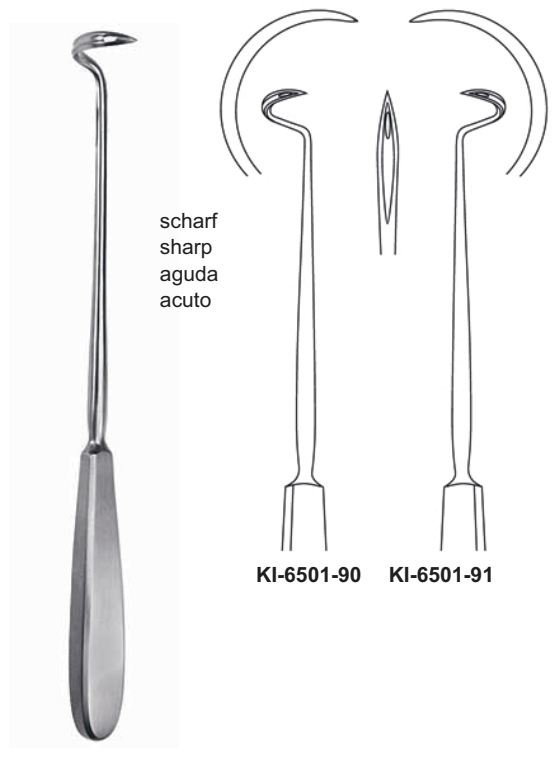

scharf  
 sharp  
 aguda  
 acuto

KI-6501-90

KI-6501-91

**DESCHAMPS**  
 20,0 cm, 8"

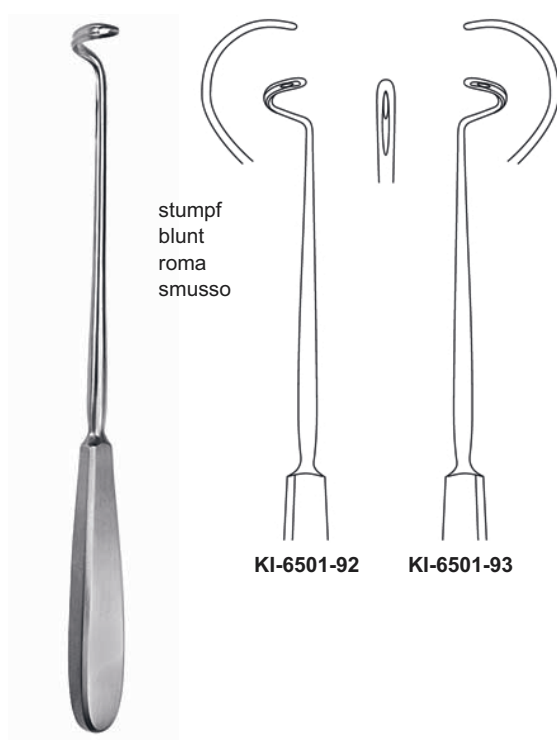

stumpf  
 blunt  
 roma  
 smusso

KI-6501-92

KI-6501-93

**DESCHAMPS**  
 20,0 cm, 8"

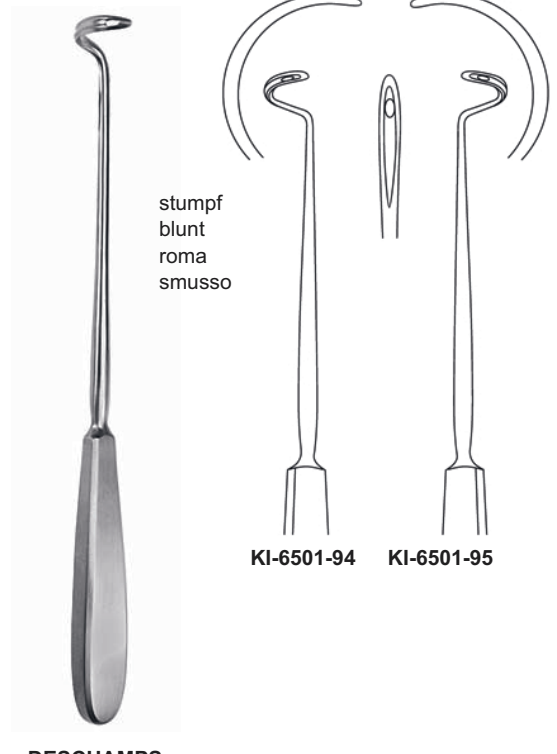

stumpf  
 blunt  
 roma  
 smusso

KI-6501-94

KI-6501-95

**DESCHAMPS**  
 20,0 cm, 8"

Unterbindungsnadeln  
 Ligature Needles  
 Aguja para ligaduras  
 Aghi per legatura

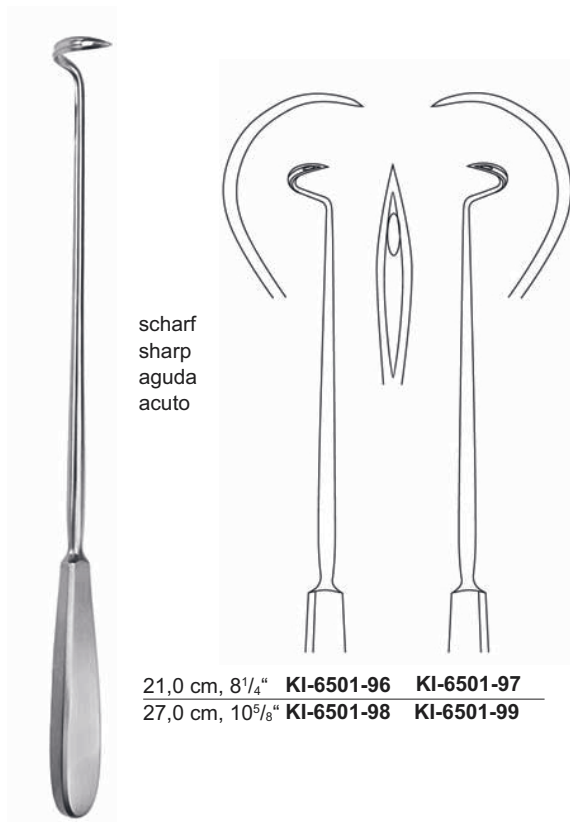

scharf  
 sharp  
 aguda  
 acuto

stumpf  
 blunt  
 roma  
 smusso

21,0 cm, 8<sup>1</sup>/<sub>4</sub>" **KI-6501-96** **KI-6501-97**  
 27,0 cm, 10<sup>5</sup>/<sub>8</sub>" **KI-6501-98** **KI-6501-99**

21,0 cm, 8<sup>1</sup>/<sub>4</sub>" **KI-6601-01** **KI-6601-02**  
 27,0 cm, 10<sup>5</sup>/<sub>8</sub>" **KI-6601-03** **KI-6601-04**

**DESCHAMPS**

**DESCHAMPS**

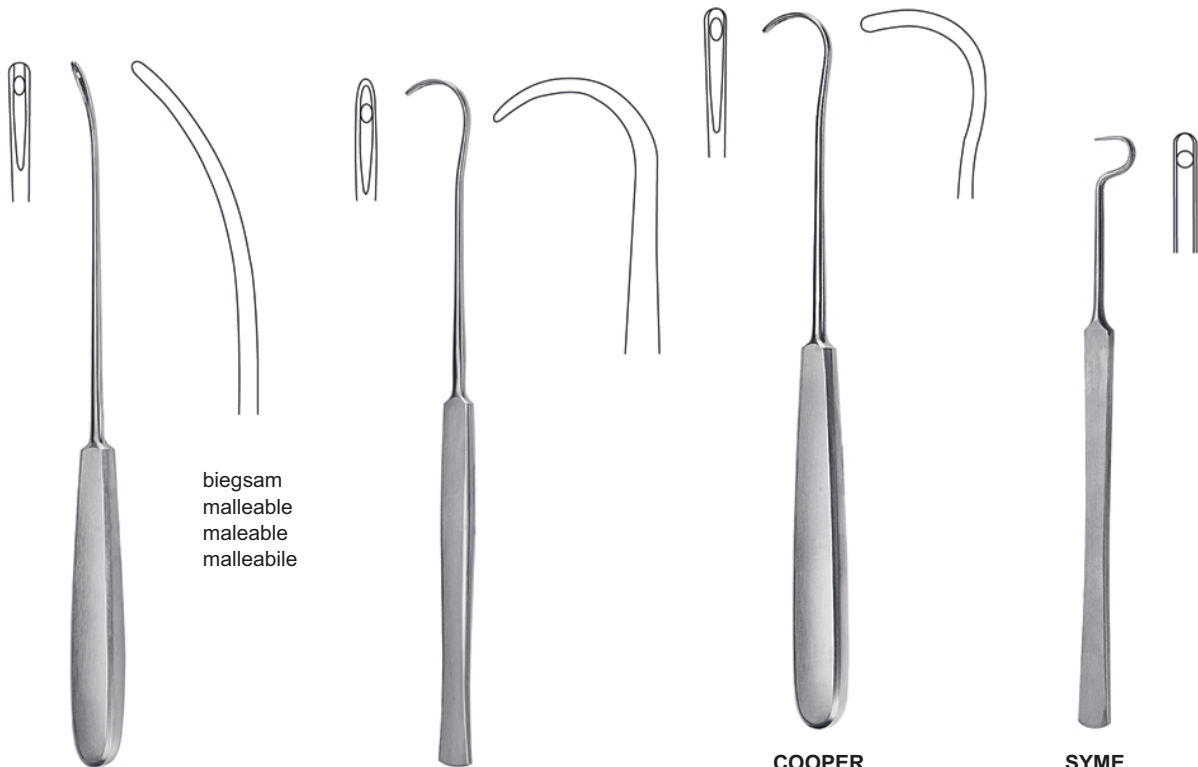

biegsam  
 malleable  
 maleable  
 malleabile

20,0 cm, 8"  
**KI-6601-05**

**COOPER**  
 19,0 cm, 7<sup>1</sup>/<sub>2</sub>"  
**KI-6601-06**

**COOPER**  
 20,0 cm, 8"  
**KI-6601-07**

**SYME**  
 15,0 cm, 6"  
**KI-6601-08**

# General Surgery Instruments



"Supporting Healthcare"  
**KAAHA INDUSTRIES**  
Manufacturer Of Dental & Surgical Instruments

Unterbindungsnadeln  
Ligature Needles  
Agujas para ligaduras  
Aghi per legatura



**KOCHER**  
19,0 cm, 7 $\frac{1}{2}$ "



KI-6601-09



KI-6601-10



KI-6601-11



**BRUNNER**  
25,0 cm, 9 $\frac{3}{4}$ "  
KI-6601-12



**BRUNNER**  
30,0 cm, 11 $\frac{3}{4}$ "



KI-6601-13



KI-6601-14



**SCHMIEDEN**  
21,0 cm, 8 $\frac{1}{4}$ "  
KI-6601-15

Unterbindungsnadeln  
 Ligature Needles  
 Agujas para ligaduras  
 Aghi per legatura



**YOUNG-HRYNTSCHAK**  
 24,0 cm, 9½"  
 KI-6601-16



KI-6601-17



KI-6601-18



KI-6601-19



**DE LA ROZA**  
 12,0 cm, 4¾"  
 KI-6601-20



**DE LA ROZA**  
 12,0 cm, 4¾"  
 KI-6601-21



**JAKOBI**  
 14,0 cm, 5½"  
 KI-6601-23



**HESSEBERG**  
 15,0 cm, 6"  
 KI-6601-24



**KRONECKER**  
 15,0 cm, 6"  
 KI-6601-25

Unterbindungsnadeln  
 Ligature Needles  
 Agujas para ligaduras  
 Aghi per legatura



**KRONECKER**  
 15,0 cm, 6"  
 KI-6601-26



**TRÉLAT**  
 23,0 cm, 9"  
 KI-6601-27



**CLAUS**  
 23,0 cm, 9"  
 KI-6601-28



**HURD**  
 21,0 cm, 8 1/4"  
 KI-6601-29



**HURD**  
 21,0 cm, 8 1/4"  
 KI-6601-30



**NAGER**  
 24,0 cm, 9 1/2"  
 KI-6601-31



**CLAUS-EICKEN**  
 23,0 cm, 9"  
 KI-6601-32



**FALK**  
 24,0 cm, 9 1/2"  
 KI-6601-33

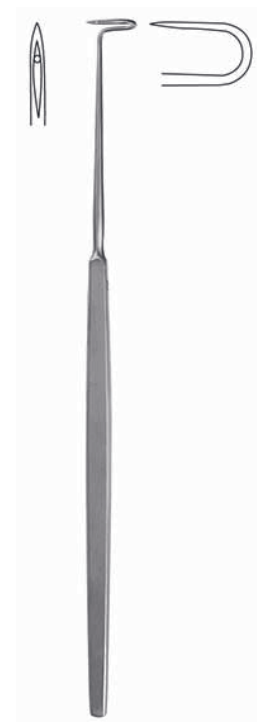

**FALK**  
 24,0 cm, 9 1/2"  
 KI-6601-34



Führungshohlsonden  
Ligature Conductors  
Sondas conductoras  
Sonde conduttrici

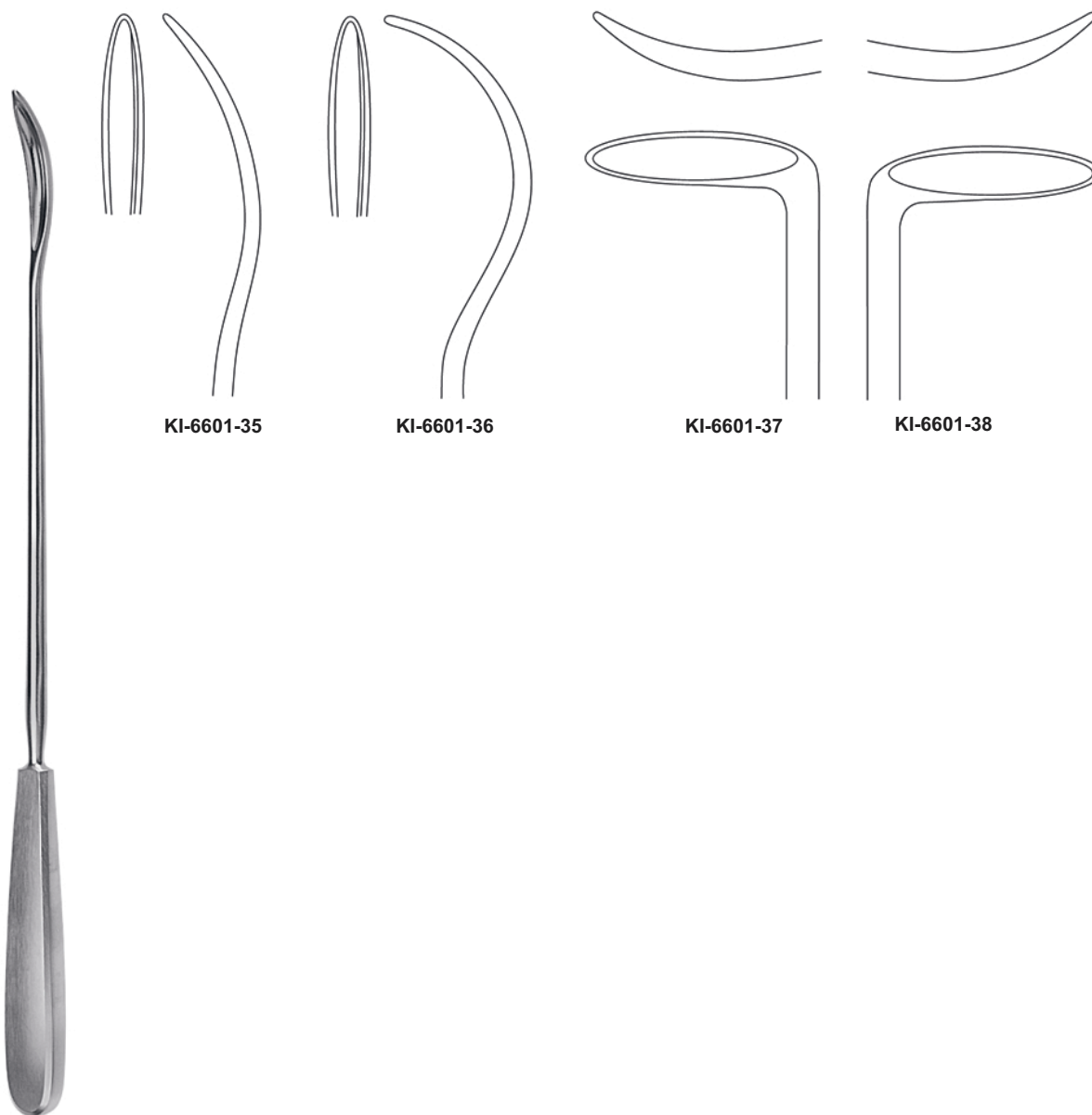

KI-6601-35

KI-6601-36

KI-6601-37

KI-6601-38

**BRUNNER**  
30,0 cm, 11<sup>3</sup>/<sub>4</sub>"

Führungshohlsonden  
 Ligature Conductors  
 Sondas conductoras  
 Sonde conduttrici



**PAYR**  
 22,0 cm, 8<sup>5</sup>/<sub>8</sub>"  
 KI-6601-39



**PAYR**  
 22,0 cm, 8<sup>5</sup>/<sub>8</sub>"  
 KI-6601-40



mit Loch  
 with hole  
 con foro  
 con ago

**SCHMIEDEN-PAYR**  
 19,0 cm, 7<sup>1</sup>/<sub>2</sub>"  
 KI-6601-41



ohne Loch  
 without hole  
 sin foro  
 senza ago

**SCHMIEDEN**  
 19,0 cm, 7<sup>1</sup>/<sub>2</sub>"  
 KI-6601-42



**KÖNIG**  
 19,5 cm, 7<sup>3</sup>/<sub>4</sub>"  
 KI-6601-43



**KÖNIG**  
 19,5 cm, 7<sup>3</sup>/<sub>4</sub>"  
 KI-6601-44



**KÖNIG**  
 19,5 cm, 7<sup>3</sup>/<sub>4</sub>"  
 KI-6601-45

Führungshohlsonden  
 Ligature Conductors  
 Sondas conductoras  
 Sonde conduttrici



**KIRSCHNER**

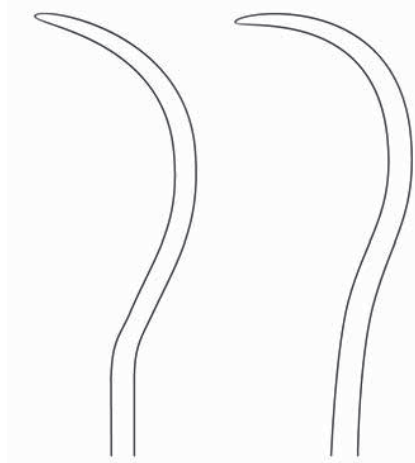

25,5 cm, 10"  
**KI-6601-46**

28,0 cm, 11"  
**KI-6601-47**



**BRUNNER-FERROZELL**

18,0 cm, 7" **KI-6601-48**

27,0 cm, 10<sup>5</sup>/<sub>8</sub>" **KI-6601-49**



**KOCHER**



15,0 cm, 6" **KI-6601-50** **KI-6601-51**  
 16,0 cm, 6<sup>1</sup>/<sub>4</sub>" **KI-6601-52** **KI-6601-53**



18,0 cm, 7"  
**KI-6601-54**



Nahtinstrumente  
 Suture Instruments  
 Instrumentos para sutura  
 Strumenti per sutura



**MOD. WIEN**  
 23,5 cm, 9 1/4"  
 KI-6601-55



**BOZEMANN**  
 21,0 cm, 8 1/4"  
 KI-6601-56



23,0 cm, 9"  
 KI-6601-57



**MICHEL**  
 12,0 cm, 4 3/4"  
 KI-6601-58



**COLLIN**  
 13,0 cm, 5"  
 KI-6601-59

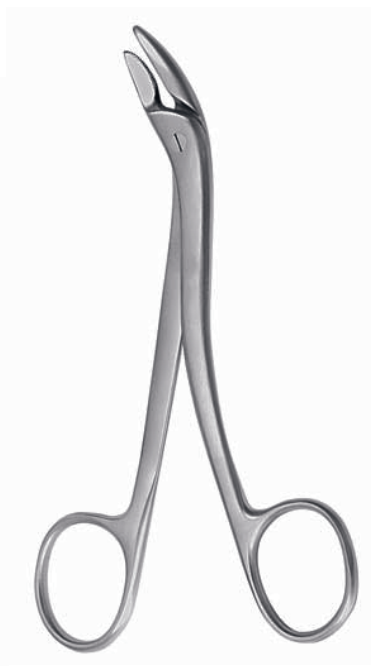

**RICHTER-HEATH**  
 14,0 cm, 5 1/2"  
 KI-6601-60



**WACHENFELDT**  
 12,5 cm, 5"  
 KI-6601-61



**HEGENBARTH**  
 12,5 cm, 5"  
 KI-6601-62

Nahtinstrumente  
 Suture Instruments  
 Instrumentos para sutura  
 Strumenti per sutura



**MICHEL**  
 12,0 cm, 4<sup>3/4</sup>"  
 KI-6601-63











**LANGE**  
 10,0 cm, 4"  
 KI-6601-64



**CHILDE**  
 18,0 cm, 7"  
 KI-6601-65



**CHILDE**  
 18,0 cm, 7"  
 KI-6601-66

-  **KI-6601-67** 7,5 x 1,75 mm
-  **KI-6601-68** 11,0 x 2,0 mm
-  **KI-6601-69** 12,0 x 3,0 mm
-  **KI-6601-70** 14,0 x 3,0 mm
-  **KI-6601-71** 16,0 x 3,0 mm
-  **KI-6601-72** 18,0 x 3,0 mm
-  **KI-6601-73** 20,0 x 3,0 mm
-  **KI-6601-74** 22,0 x 3,0 mm

**MICHEL**

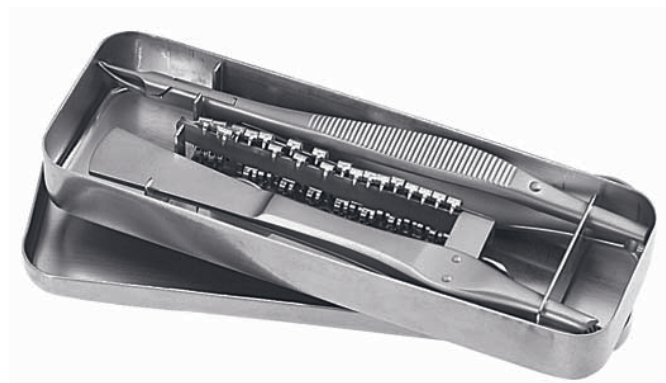

**CLIP-SET**  
**KI-6601-75**

bestehend aus, consisting of, compuesto de, composto da

- 1 x **KI-6601-76**
- 1 x **KI-6601-77**
- 50 x **KI-6601-78**
- 1 x **KI-6601-79** (Etui)



“Supporting Healthcare”

**KAAHA INDUSTRIES**

Manufacturer Of Dental & Surgical Instruments



**Wundhaken**

**Retractors**

**Separadores**

**Divaricatori**

Dura- und Hauthäkchen  
 Dura and Skin Retractors  
 Gancho para piel y dura-madre  
 Unico per pelle e dura-madre



**GILLIES**  
 18,0 cm, 7"



**KILNER**  
 15,0 cm, 6"  
 KI-6701-03



**FRAZIER**  
 13,0 cm, 5"  
 KI-6701-04



**O'CONNOR**  
 16,0 cm, 6 1/4"  
 KI-6701-05



**KLEINEKI-KUTZ**  
 16,0 cm, 6 1/4"



**JOSEPH**  
 16,0 cm, 6 1/4"  
 KI-6701-09



**GRAEFE**  
 16,0 cm, 6 1/4"



Dura- und Hauthäkchen  
 Dura and Skin Retractors  
 Gancho para piel y dura-madre  
 Unico per pelle e dura-madre



16,0 cm, 6 1/4"



Fig. 1  
 KI-6701-12



Fig. 2  
 KI-6701-13



Fig. 3  
 KI-6701-14



Fig. 4  
 KI-6701-15



**GUTHRIE**  
 16,0 cm, 6 1/4"



Fig. 1  
 KI-6701-16



Fig. 2  
 KI-6701-17



**JOSEPH**  
 16,0 cm, 6 1/4"



Fig. 1  
 KI-6701-18



Fig. 2  
 KI-6701-19



Fig. 3  
 KI-6701-20



Fig. 4  
 KI-6701-21

# General Surgery Instruments



"Supporting Healthcare"  
**KAAHA INDUSTRIES**  
 Manufacturer Of Dental & Surgical Instruments

Wundhaken  
 Retractors  
 Separadores  
 Divaricatori

**KNAPP**  
 13,0 cm, 5"

Fig. 1  
**KI-6701-22**

scharf  
 sharp  
 agudos  
 acuti

Fig. 2  
**KI-6701-23**

stumpf  
 blunt  
 romo  
 smusso

**KI-6701-24**

**KI-6701-25**

**KI-6701-26**

**KI-6701-27**

**KI-6701-28**

**KI-6701-29**

fl exibel · fl exible · fl exibles · fl essibili

16,0 cm, 6 1/4"

**KNAPP**  
 16,0 cm, 6 1/4"

**KI-6701-30**

**KI-6701-31**

**KI-6701-32**

**KI-6701-33**

scharf  
 sharp  
 agudos  
 acuti

**KI-6701-34**

**KI-6701-35**

**KI-6701-36**

**KI-6701-37**

halbscharf  
 semi-sharp

semi-acuti  
 semi-agudos

**KI-6701-38**

**KI-6701-39**

**KI-6701-40**

**KI-6701-41**

stumpf  
 blunt  
 romo  
 smusso

**Wundhaken  
 Retractors  
 Separadores  
 Divaricatori**



16,0 cm, 6 1/4"



KI-6701-42



KI-6701-43



KI-6701-44



KI-6701-45



KI-6701-46



KI-6701-47



KI-6701-48

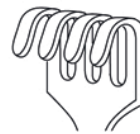

KI-6701-49

scharf  
 sharp  
 agudos  
 acuti

stumpf  
 blunt  
 romo  
 smusso



**CUSHING**  
 19,0 cm, 7 1/2"



Fig. 1  
 KI-6701-50



Fig. 2  
 KI-6701-51



**LANGENBECK-GREEN**  
 16,0 cm, 6 1/4"



16 x 6 mm  
 KI-6701-52



24 x 6 mm  
 KI-6701-53

# General Surgery Instruments



"Supporting Healthcare"  
**KAAHA INDUSTRIES**  
 Manufacturer Of Dental & Surgical Instruments

Wundhaken  
 Retractors  
 Separadores  
 Divaricatori



**MEYERDING**  
 18,0 cm, 7"



18 x 7 mm  
**KI-6701-54**



16 x 5 mm  
**KI-6701-55**



7 x 4 mm  
**KI-6701-56**



10 x 3 mm  
**KI-6701-57**



7 x 4 mm  
**KI-6701-58**



4 x 10 mm  
**KI-6701-59**



16,0 cm, 6 1/4"



14 x 8 mm  
**KI-6701-60**



**SENN-GREEN**  
 15,0 cm, 6"



10 x 6 mm  
**KI-6701-61**

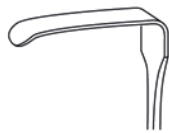

20 x 6 mm  
**KI-6701-62**



**MINI-LANGENBECK**  
 16,0 cm, 6 1/4"



10 x 6 mm  
**KI-6701-63**

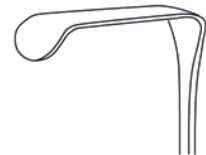

17 x 5 mm  
**KI-6701-64**



20 x 6 mm  
**KI-6701-65**



22 x 8 mm  
**KI-6701-66**



Wundhaken  
 Retractors  
 Separadores  
 Divaricatori



**RAGNELL-DAVIS**  
 14,0 cm, 5 1/2"  
 KI-6701-67



**RAGNELL**  
 15,0 cm, 6"  
 KI-6701-68

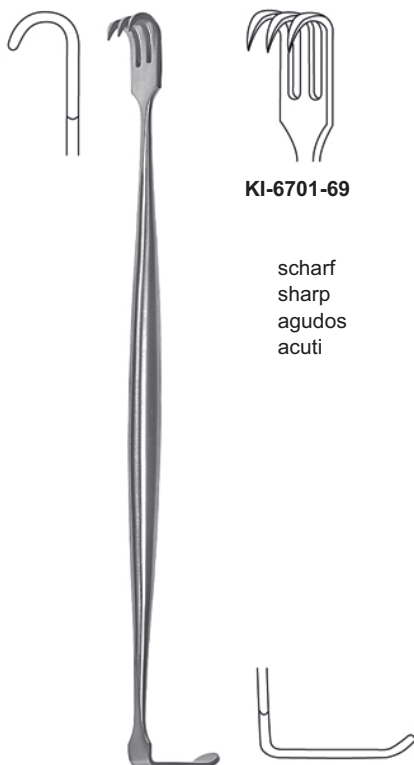

**BABY SENN-MILLER**  
 15,0 cm, 6"

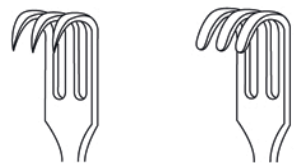

KI-6701-69

scharf  
 sharp  
 agudos  
 acuti



KI-6701-70

stumpf  
 blunt  
 romo  
 smusso

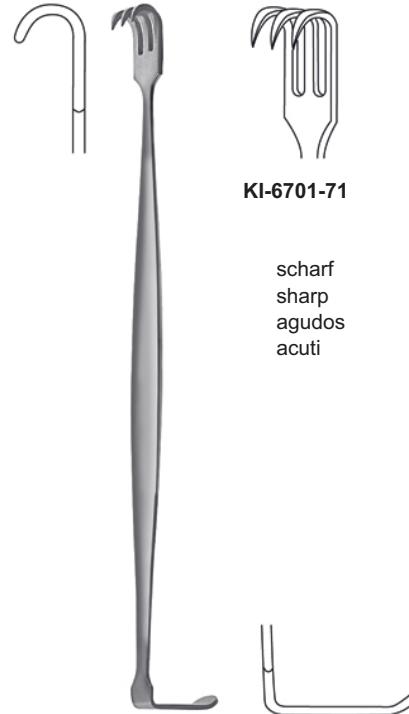

**SENN-MILLER**  
 16,0 cm, 6 1/4"



KI-6701-71

scharf  
 sharp  
 agudos  
 acuti



KI-6701-72

stumpf  
 blunt  
 romo  
 smusso

Wundhaken  
 Retractors  
 Separadores  
 Divaricatori



**DESMARRES**  
 13,0 cm, 5"

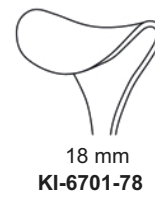
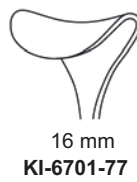
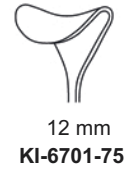
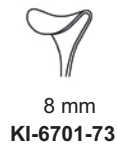

**DESMARRES**  
 16,0 cm, 6 1/4"

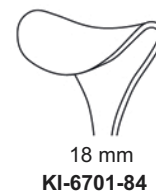
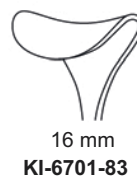
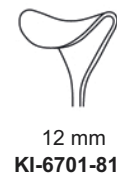
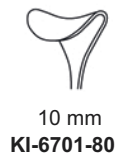

Wundhaken  
Retractors  
Separadores  
Divaricatori



**CUSHING**  
20,0 cm, 8"

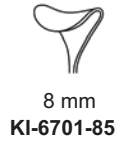

**CUSHING**  
24,0 cm, 9 1/2"

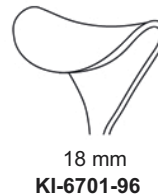
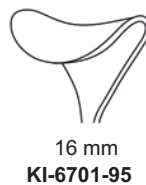
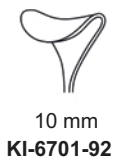

Wundhaken  
 Retractors  
 Separadores  
 Divaricatori



**GIL-VERNET**  
 24,0 cm, 9 1/2"

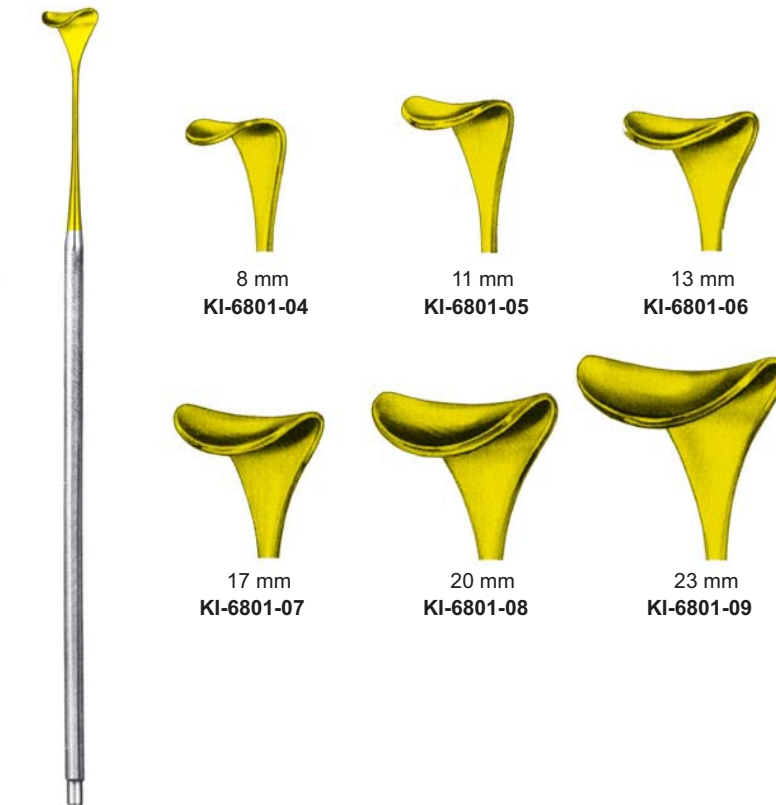

**GIL-VERNET**  
 24,0 cm, 9 1/2"

Wundhaken  
 Retractors  
 Separadores  
 Divaricatori



**ROUX**

- Fig. 1 24 x 20 mm
- Fig. 2 29 x 26 mm
- Fig. 3 33 x 29 mm
- Fig. 4 29 x 24 mm

Satz, Fig. 1-3  
 Set, fig. 1-3  
 Juego, fig. 1-3  
 Serie, fig. 1-3

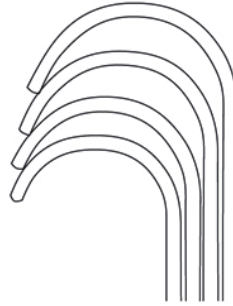

- Fig. 1 30 x 28 mm
- Fig. 2 36 x 36 mm
- Fig. 3 38 x 43 mm
- Fig. 4 45 x 28 mm

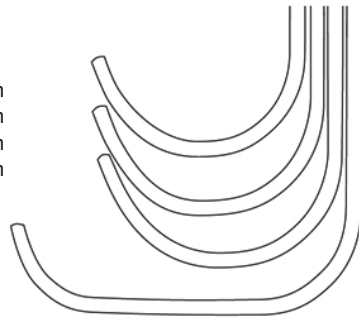

- |          |  |                   |
|----------|--|-------------------|
| Fig. 1-3 | 17,0 cm, 6 <sup>3</sup> / <sub>4</sub> " | <b>KI-6801-10</b> |
| Fig. 1   | 14,0 cm, 5 <sup>1</sup> / <sub>2</sub> " | <b>KI-6801-11</b> |
| Fig. 2   | 15,0 cm, 6"                              | <b>KI-6801-12</b> |
| Fig. 3   | 17,0 cm, 6 <sup>3</sup> / <sub>4</sub> " | <b>KI-6801-13</b> |
| Fig. 4   | 18,0 cm, 7"                              | <b>KI-6801-14</b> |



**FARABEUF**  
 12,0 cm, 4<sup>3</sup>/<sub>4</sub>"  
**KI-6801-15**

- Fig. 2 30 x 10 mm
- Fig. 1 26 x 10 mm

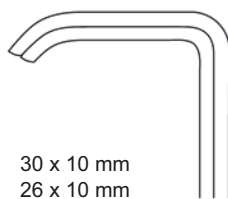

- Fig. 1 30 x 13 mm
- Fig. 2 34 x 13 mm

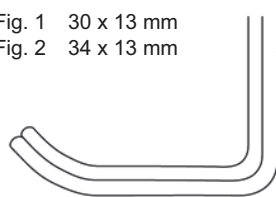

**FARABEUF**  
 15,0 cm, 5<sup>3</sup>/<sub>4</sub>"  
**KI-6801-16**

- Fig. 2 23 x 16 mm
- Fig. 1 27 x 16 mm

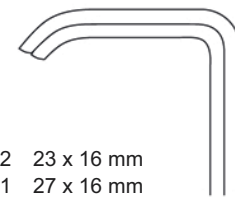

- Fig. 1 26 x 16 mm
- Fig. 2 30 x 16 mm

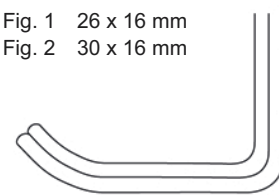

Wundhaken  
 Retractors  
 Separadores  
 Divaricatori



**MINI-ROUX**  
 14,0 cm, 5 1/2"  
 KI-6801-17



**BABY-ROUX**  
 13,0 cm, 5"  
 KI-6801-18

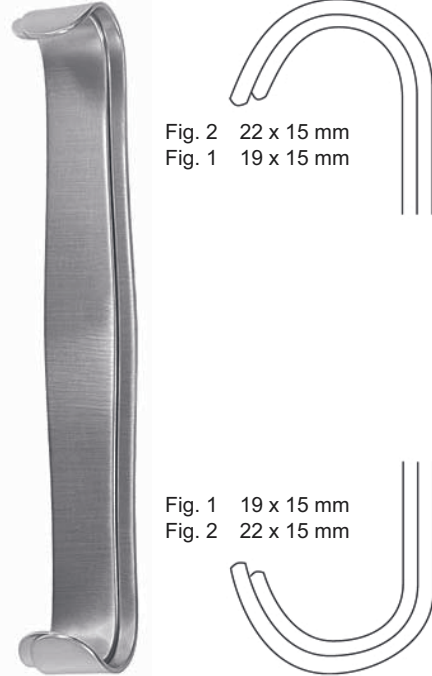

**PARKER**  
 13,5 cm, 5 3/8"  
 KI-6801-19

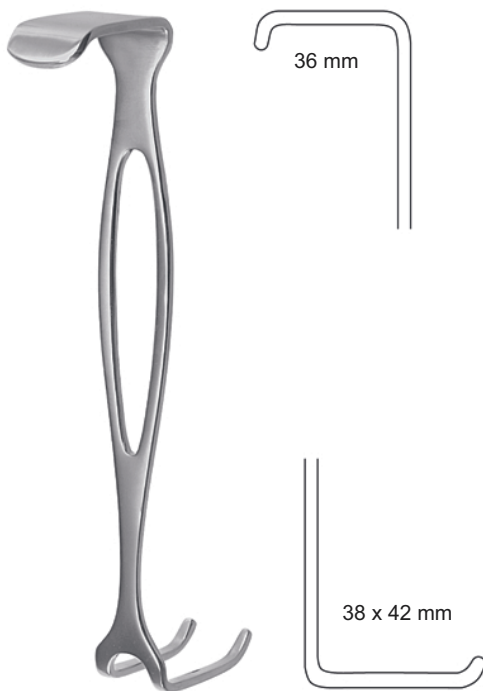

**CZERNY**  
 17,5 cm, 7"  
 KI-6801-20

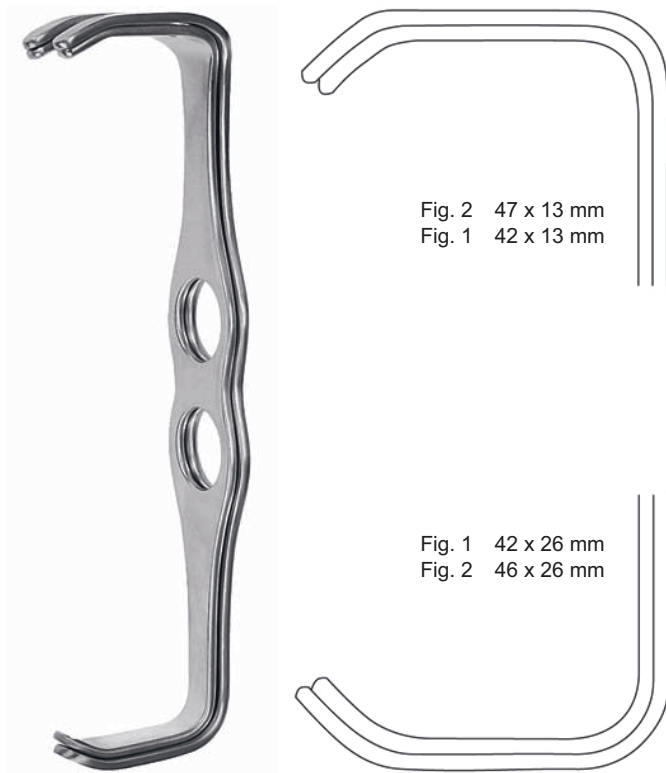

**MATHIEU**  
 20,0 cm, 8"  
 KI-6801-21

Wundhaken  
 Retractors  
 Separadores  
 Divaricatori



**GOELET**  
 19,0 cm, 7 1/2"  
 KI-6801-22

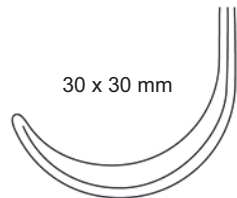
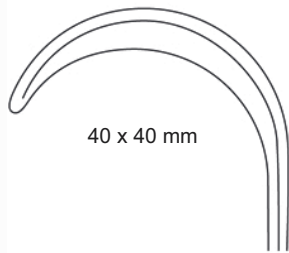

**PARKER-LANGENBECK**  
 21,0 cm, 8 1/4"  
 KI-6801-23

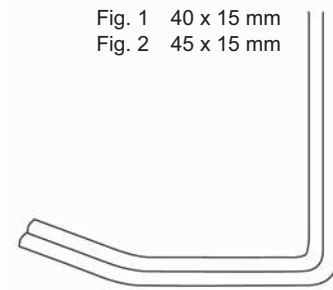
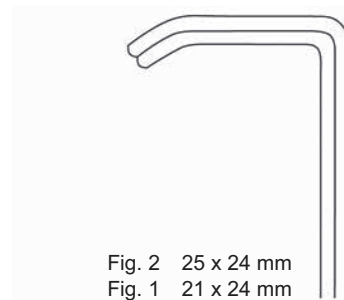

**CANNY RYAL**

16 mm	19,0 cm, 7 1/2"	<b>KI-6801-24</b>
20 mm	19,0 cm, 7 1/2"	<b>KI-6801-25</b>
25 mm	20,0 cm, 8"	<b>KI-6801-26</b>

Wundhaken  
 Retractors  
 Separadores  
 Divaricatori



**VOLKMANN**  
 21,5 cm, 8½"



**KI-6801-27**



9 x 8 mm  
**KI-6801-28**



9 x 13 mm  
**KI-6801-29**



9 x 19 mm  
**KI-6801-30**



9 x 29 mm  
**KI-6801-31**

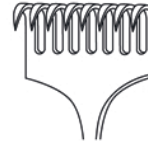

9 x 40 mm  
**KI-6801-32**

scharf  
 sharp  
 agudos  
 acuti



**VOLKMANN**  
 21,5 cm, 8½"



**KI-6801-33**



9 x 8 mm  
**KI-6801-34**



9 x 13 mm  
**KI-6801-35**



9 x 19 mm  
**KI-6801-36**



9 x 29 mm  
**KI-6801-37**

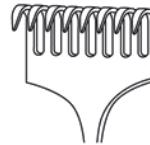

9 x 40 mm  
**KI-6801-38**

halbscharf  
 semi-sharp  
 semi-agudos  
 semi-acuti



Wundhaken  
 Retractors  
 Separadores  
 Divaricatori



**VOLKMANN**  
 21,5 cm, 8½"



**KI-6801-39**



9 x 8 mm  
**KI-6801-40**



9 x 13 mm  
**KI-6801-41**



9 x 19 mm  
**KI-6801-42**



9 x 29 mm  
**KI-6801-43**

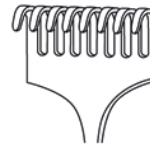

9 x 40 mm  
**KI-6801-44**

stumpf  
 blunt  
 romo  
 smusso



**KI-6801-45**



9 x 8 mm  
**KI-6801-46**



15 x 15 mm  
**KI-6801-47**



15 x 20 mm  
**KI-6801-48**



15 x 30 mm  
**KI-6801-49**

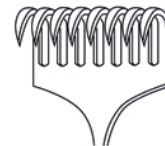

15 x 40 mm  
**KI-6801-50**

scharf  
 sharp  
 agudos  
 acuti



**KOCHER**  
 22,0 cm, 8⅝"

Wundhaken  
 Retractors  
 Separadores  
 Divaricatori



**KOCHER**  
 22,0 cm, 8<sup>5</sup>/<sub>8</sub>"



**KI-6801-51**



9 x 8 mm  
**KI-6801-52**



15 x 15 mm  
**KI-6801-53**



15 x 20 mm  
**KI-6801-54**

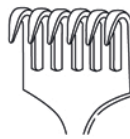

15 x 30 mm  
**KI-6801-55**

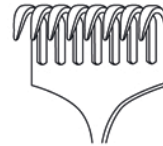

15 x 40 mm  
**KI-6801-56**

halbscharf  
 semi-sharp  
 semi-agudos  
 semi-acuti



**KOCHER**  
 22,0 cm, 8<sup>5</sup>/<sub>8</sub>"



**KI-6801-57**



9 x 8 mm  
**KI-6801-58**



15 x 15 mm  
**KI-6801-59**



15 x 20 mm  
**KI-6801-60**

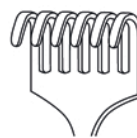

15 x 30 mm  
**KI-6801-61**

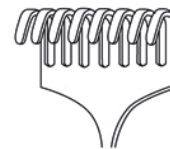

15 x 40 mm  
**KI-6801-62**

stumpf  
 blunt  
 romo  
 smusso

Wundhaken  
 Retractors  
 Separadores  
 Divaricatori

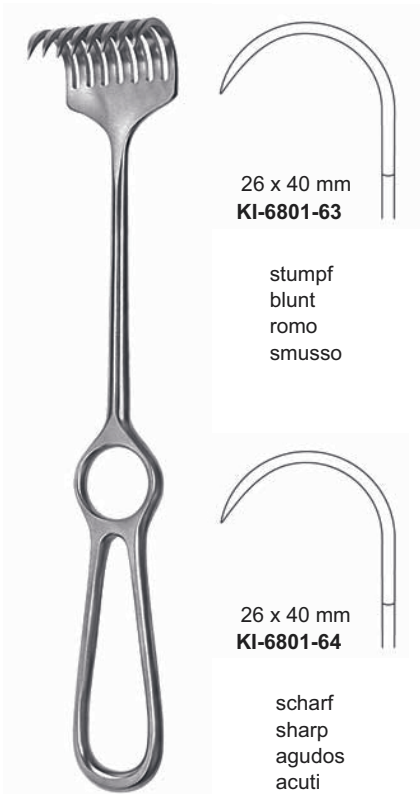

26 x 40 mm  
**KI-6801-63**

stumpf  
 blunt  
 romo  
 smusso

26 x 40 mm  
**KI-6801-64**

scharf  
 sharp  
 agudos  
 acuti

**KOERTE**  
 24,0 cm, 9 1/2"



**LANGENBECK**  
 21,0 cm, 8 1/4"

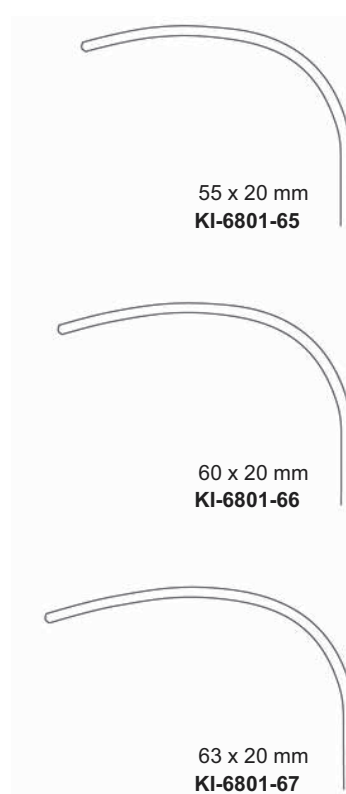

55 x 20 mm  
**KI-6801-65**

60 x 20 mm  
**KI-6801-66**

63 x 20 mm  
**KI-6801-67**



**ISRAEL**  
 25,0 cm, 9 3/4"

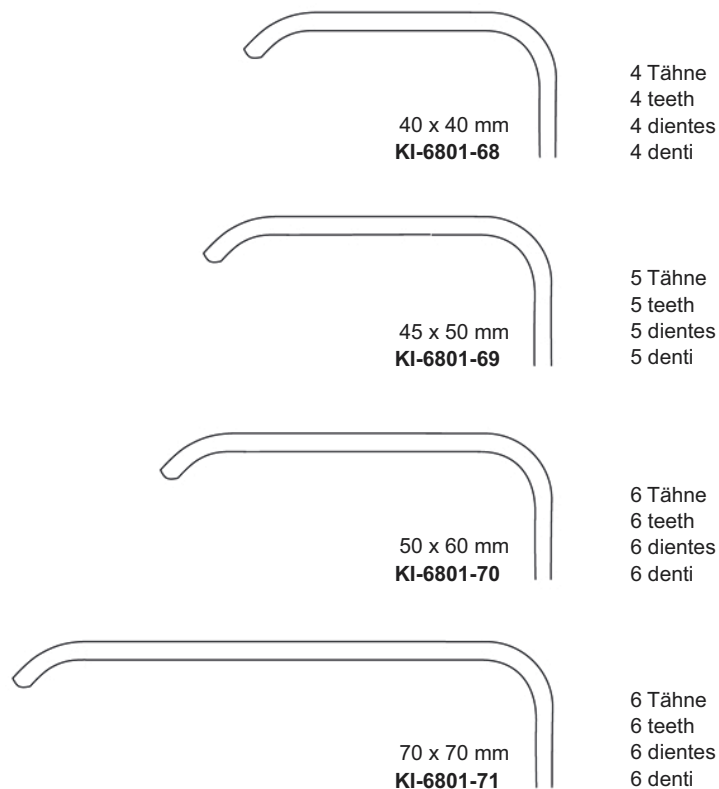

40 x 40 mm  
**KI-6801-68**

4 Tähne  
 4 teeth  
 4 dientes  
 4 denti

45 x 50 mm  
**KI-6801-69**

5 Tähne  
 5 teeth  
 5 dientes  
 5 denti

50 x 60 mm  
**KI-6801-70**

6 Tähne  
 6 teeth  
 6 dientes  
 6 denti

70 x 70 mm  
**KI-6801-71**

6 Tähne  
 6 teeth  
 6 dientes  
 6 denti

Wundhaken  
 Retractors  
 Separadores  
 Divaricatori



**LANGENBECK**  
 22,0 cm, 8<sup>5</sup>/<sub>8</sub>"

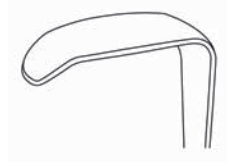

30 x 11 mm  
**KI-6801-72**

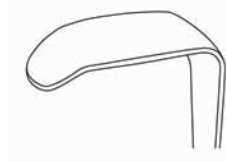

30 x 14 mm  
**KI-6801-73**



30 x 16 mm  
**KI-6801-74**

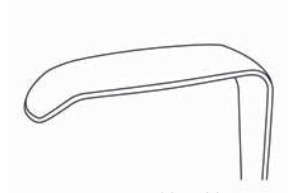

40 x 11 mm  
**KI-6801-75**



50 x 11 mm  
**KI-6801-76**



**LANGENBECK**  
 22,0 cm, 8<sup>5</sup>/<sub>8</sub>"

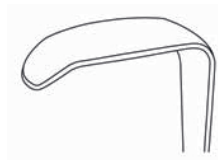

30 x 11 mm  
**KI-6801-77**



30 x 14 mm  
**KI-6801-78**



30 x 16 mm  
**KI-6801-79**

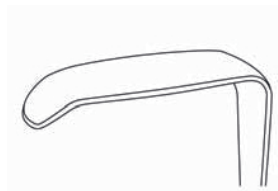

40 x 11 mm  
**KI-6801-80**



50 x 11 mm  
**KI-6801-81**



**Wundhaken  
 Retractors  
 Separadores  
 Divaricatori**



**KOCHER-LANGENBECK**  
 21,5 cm, 8½"

	22 x 6 mm <b>KI-6801-82</b>
	25 x 6 mm <b>KI-6801-83</b>
	25 x 8 mm <b>KI-6801-84</b>
	35 x 8 mm <b>KI-6801-85</b>
	35 x 11 mm <b>KI-6801-86</b>
	35 x 15 mm <b>KI-6801-87</b>
	40 x 11 mm <b>KI-6801-88</b>
	70 x 15 mm <b>KI-6801-89</b>
	80 x 12 mm <b>KI-6801-90</b>
	80 x 15 mm <b>KI-6801-91</b>
	22 x 6 mm <b>KI-6801-92</b>

Wundhaken  
 Retractors  
 Separadores  
 Divaricatori



**KOCHER**  
 23,0 cm, 9"

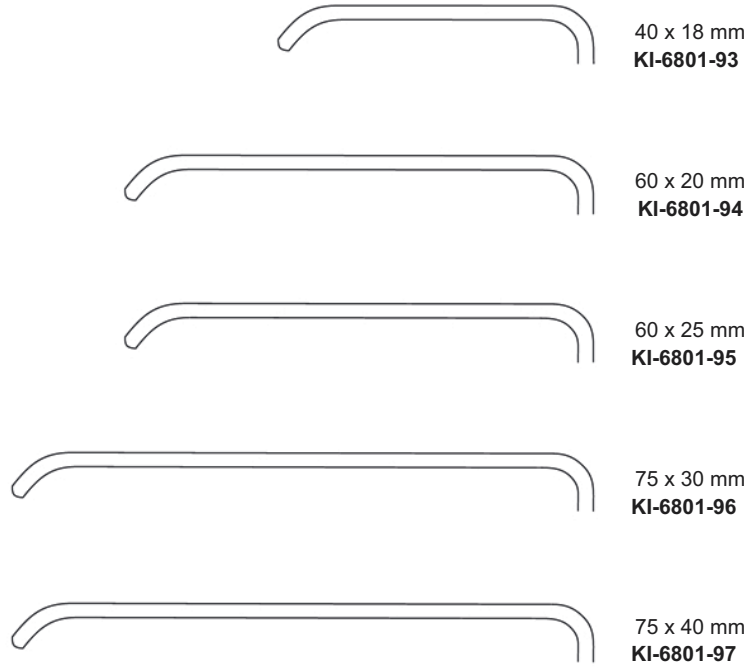

**SAUERBRUCH**  
 22,5 cm, 8<sup>3</sup>/<sub>4</sub>"

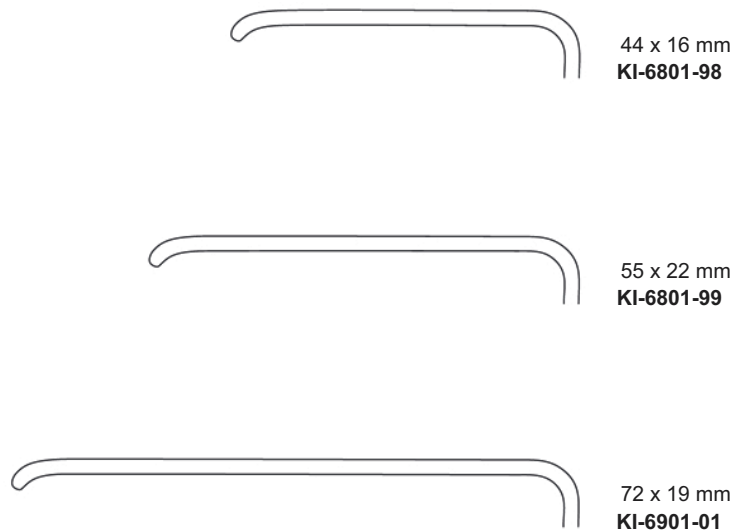

Wundhaken  
 Retractors  
 Separadores  
 Divaricatori



**MIDDELDORPF**



21,5 cm, 8 1/2"  
 14 x 17 mm  
**KI-6901-02**



22,0 cm, 8 5/8"  
 20 x 22 mm  
**KI-6901-03**



23,5 cm, 9 1/4"  
 26 x 30 mm  
**KI-6901-04**



**MIDDELDORPF**



21,5 cm, 8 1/2"  
 14 x 17 mm  
**KI-6901-05**



22,0 cm, 8 5/8"  
 20 x 22 mm  
**KI-6901-06**



23,5 cm, 9 1/4"  
 26 x 30 mm  
**KI-6901-07**



**RICHARDSON (KELLY)**  
 24,0 cm, 9 1/2"



**KI-6901-08**



9 x 8 mm  
**KI-6901-09**



15 x 15 mm  
**KI-6901-10**

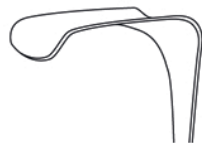

15 x 20 mm  
**KI-6901-11**



15 x 30 mm  
**KI-6901-12**



15 x 40 mm  
**KI-6901-13**

Wundhaken  
 Retractors  
 Separadores  
 Divaricatori

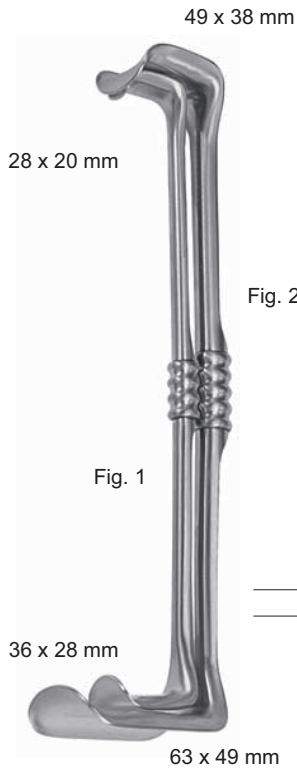

Fig. 2

Fig. 1

Fig. 1+2 28,0 cm, 11" **KI-6901-14**  
 Fig. 1 26,0 cm, 10<sup>1</sup>/<sub>4</sub>" **KI-6901-15**  
 Fig. 2 28,0 cm, 11" **KI-6901-16**



40 x 45 mm **KI-6901-17**  
 45 x 50 mm **KI-6901-18**  
 55 x 70 mm **KI-6901-19**

**RICHARDSON-EASTMAN**

**MIDDELDORPF**  
 25,5 cm, 10"



45 x 40 mm **KI-6901-20**  
 45 x 50 mm **KI-6901-21**  
 45 x 60 mm **KI-6901-22**  
 55 x 75 mm **KI-6901-23**  
 65 x 85 mm **KI-6901-24**

**FRITSCH**  
 24,0 cm, 9<sup>1</sup>/<sub>2</sub>"



50 x 85 mm

**DOYEN**  
 25,0 cm, 10"  
 029-230-501



Wundhaken  
 Retractors  
 Separadores  
 Divaricatori



**DOYEN-STILLE**  
 22,0 cm, 8<sup>5</sup>/<sub>8</sub>"

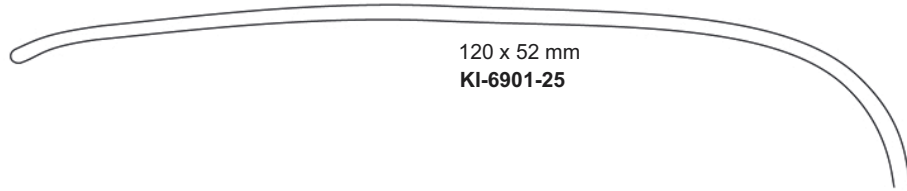

120 x 52 mm  
**KI-6901-25**

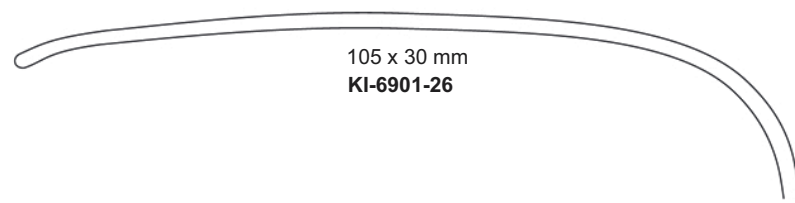

105 x 30 mm  
**KI-6901-26**

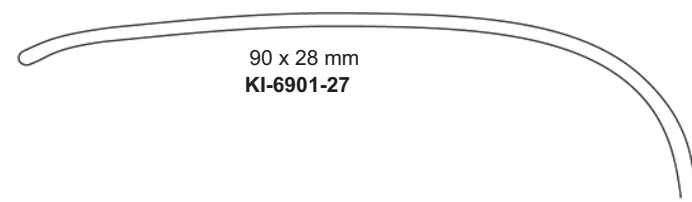

90 x 28 mm  
**KI-6901-27**

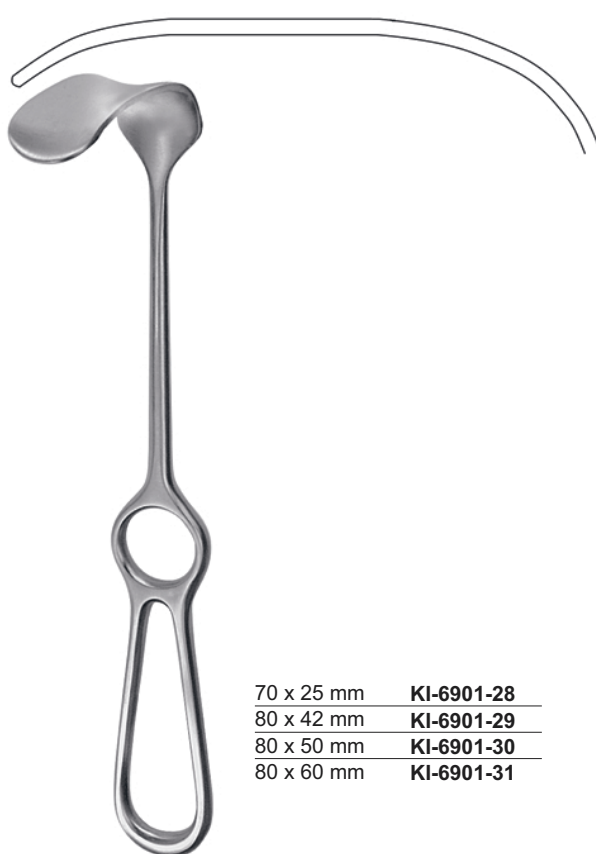

**KOCHER**  
 25,0 cm, 10"

- 70 x 25 mm **KI-6901-28**
- 80 x 42 mm **KI-6901-29**
- 80 x 50 mm **KI-6901-30**
- 80 x 60 mm **KI-6901-31**



**LAHEY**  
 19,0 cm, 7<sup>1</sup>/<sub>2</sub>"  
**KI-6901-32**

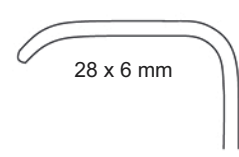

28 x 6 mm

# General Surgery Instruments



"Supporting Healthcare"  
**KAAHA INDUSTRIES**  
 Manufacturer Of Dental & Surgical Instruments

Wundhaken  
 Retractors  
 Separadores  
 Divaricatori

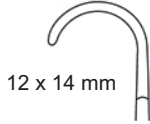

12 x 14 mm

**LITTLE**  
 20,0 cm, 8"  
 KI-6901-33



115 x 22 mm **KI-6901-34**  
 115 x 27 mm **KI-6901-35**

**SIMON**  
 28,0 cm, 11"

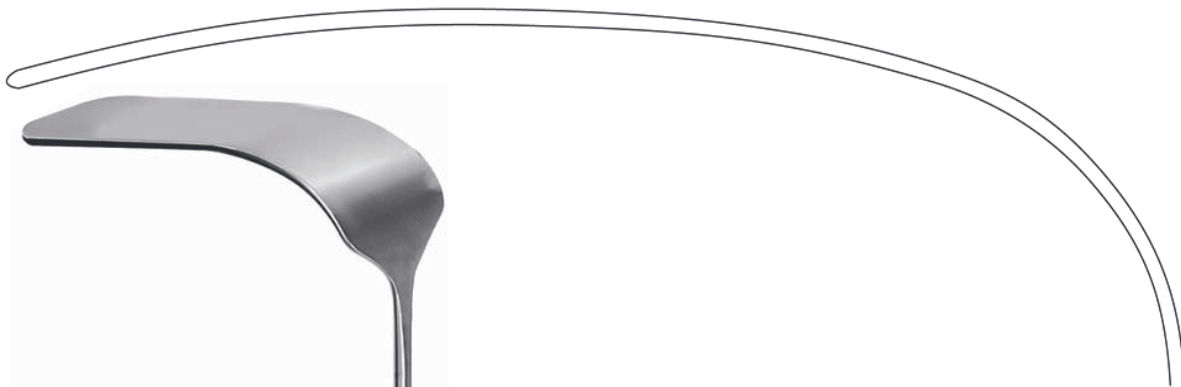

160 x 38 mm **KI-6901-36**  
 160 x 57 mm **KI-6901-37**  
 190 x 38 mm **KI-6901-38**  
 190 x 57 mm **KI-6901-39**

**KELLY**  
 27,0 cm, 10 1/2"

Wundhaken  
 Retractors  
 Separadores  
 Divaricatori



85 x 35 mm	<b>KI-6901-40</b>
120 x 50 mm	<b>KI-6901-41</b>
155 x 50 mm	<b>KI-6901-42</b>

**MIKULICZ**  
 26,0 cm, 10<sup>1</sup>/<sub>4</sub>"



90 x 50 mm

**MIKULICZ**  
 26,0 cm, 10<sup>1</sup>/<sub>4</sub>"  
**KI-6901-43**



70 x 38 mm	<b>KI-6901-44</b>
70 x 50 mm	<b>KI-6901-45</b>

**MORRIS**  
 24,5 cm, 9<sup>5</sup>/<sub>8</sub>"

# General Surgery Instruments



"Supporting Healthcare"  
**KAAHA INDUSTRIES**  
 Manufacturer Of Dental & Surgical Instruments

Wundhaken  
 Retractors  
 Separadores  
 Divaricatori

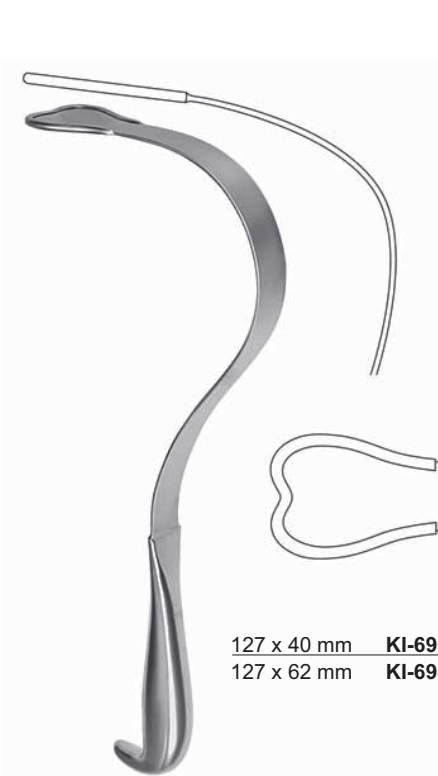

127 x 40 mm **KI-6901-46**  
 127 x 62 mm **KI-6901-47**

**HARRINGTON**  
 32,0 cm, 12<sup>1</sup>/<sub>2</sub>"



82 x 22 mm **KI-6901-48**  
 108 x 43 mm **KI-6901-49**  
 115 x 65 mm **KI-6901-50**

**CORYKKOS**  
 24,0 cm, 9<sup>1</sup>/<sub>2</sub>"



**ZENKER**

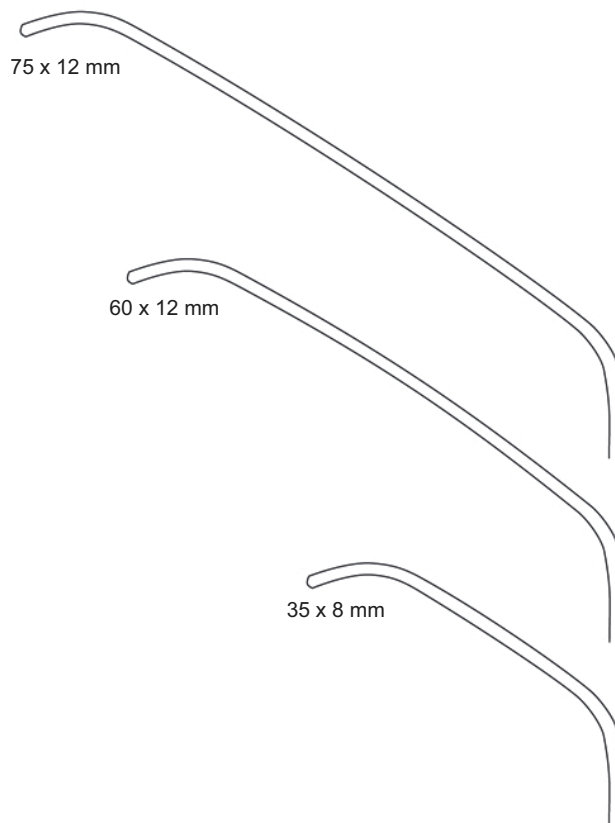

75 x 12 mm

60 x 12 mm

35 x 8 mm

25,0 cm, 9<sup>3</sup>/<sub>4</sub>"  
**KI-6901-51**

26,0 cm, 10<sup>1</sup>/<sub>4</sub>"  
**KI-6901-52**

27,5 cm, 10<sup>3</sup>/<sub>4</sub>"  
**KI-6901-53**

Wundhaken  
Retractors  
Separadores  
Divaricatori



**MEYERDING**  
22,5 cm, 8<sup>3</sup>/<sub>4</sub>"

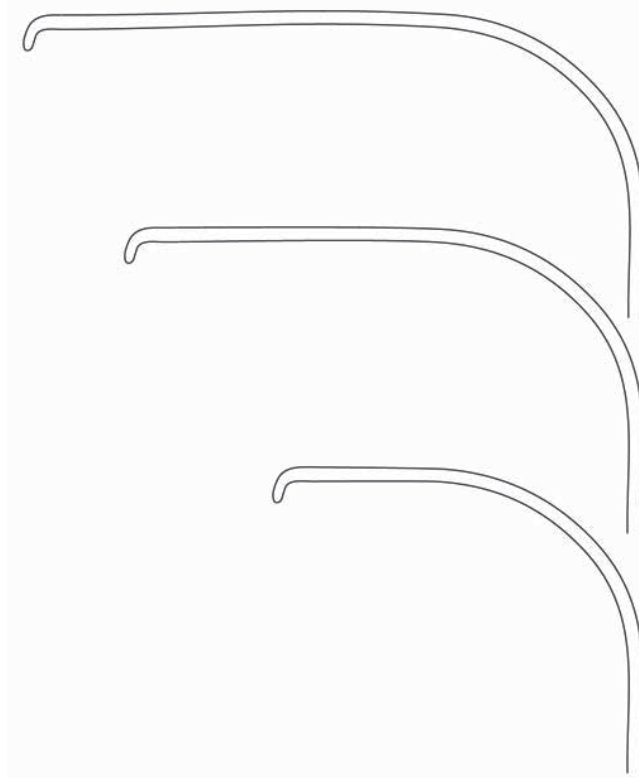

90 x 50 mm  
**KI-6901-54**

75 x 25 mm  
**KI-6901-55**

50 x 16 mm  
**KI-6901-56**



**BRUNNER**  
25,0 cm, 10"

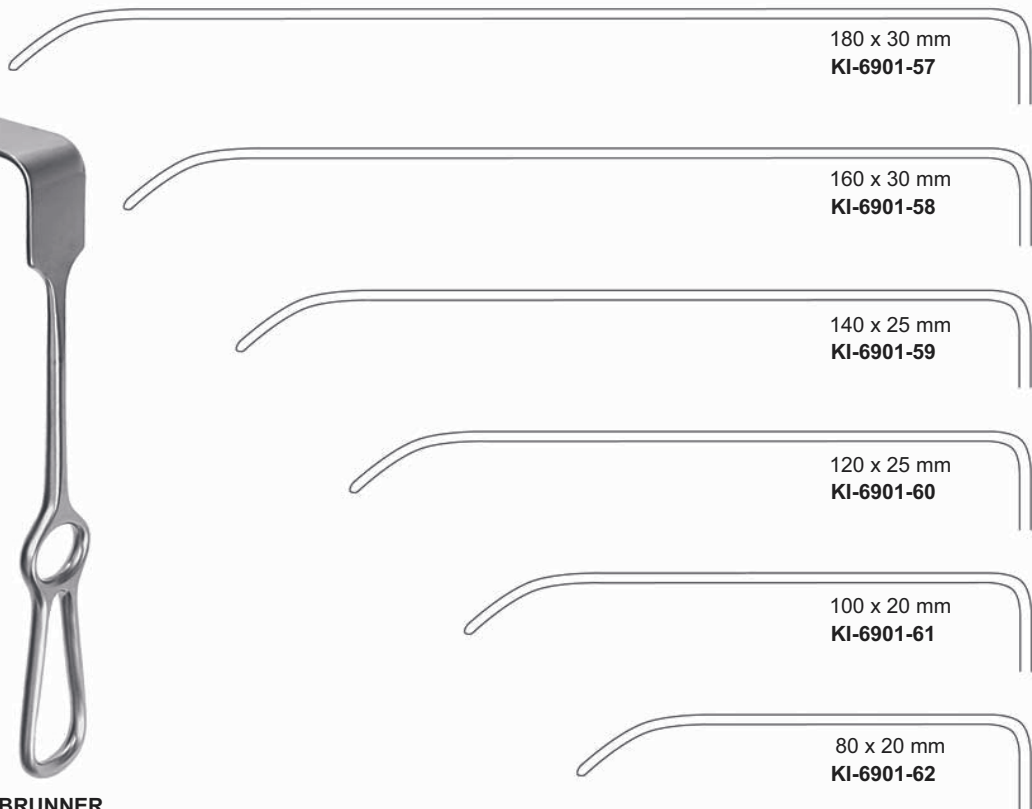

180 x 30 mm  
**KI-6901-57**

160 x 30 mm  
**KI-6901-58**

140 x 25 mm  
**KI-6901-59**

120 x 25 mm  
**KI-6901-60**

100 x 20 mm  
**KI-6901-61**

80 x 20 mm  
**KI-6901-62**

Wundhaken  
 Retractors  
 Separadores  
 Divaricatori

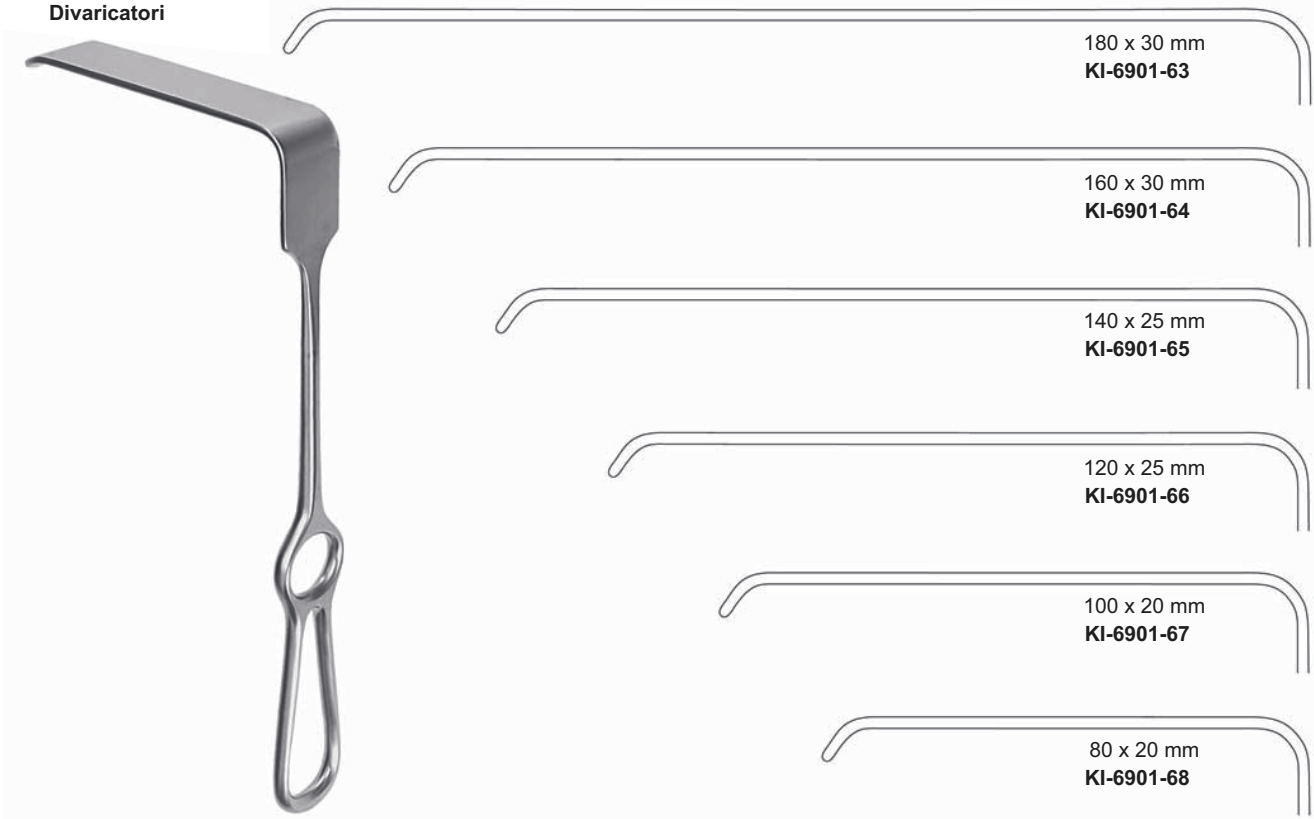

**BRUNNER**  
 25,0 cm, 10"



19 mm

**DEAVER**  
 18,0 cm, 7"  
 KI-6901-69



22 mm

**DEAVER**  
 21,5 cm, 8½"  
 KI-6901-70

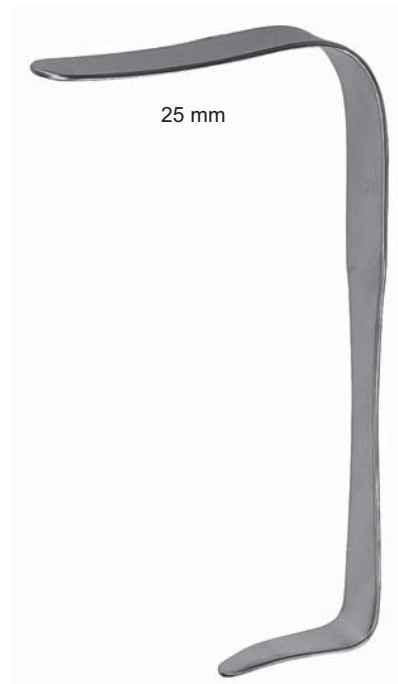

25 mm

**DEAVER**  
 23,0 cm, 9"  
 KI-6901-71

Wundhaken  
Retractors  
Separadores  
Divaricatori

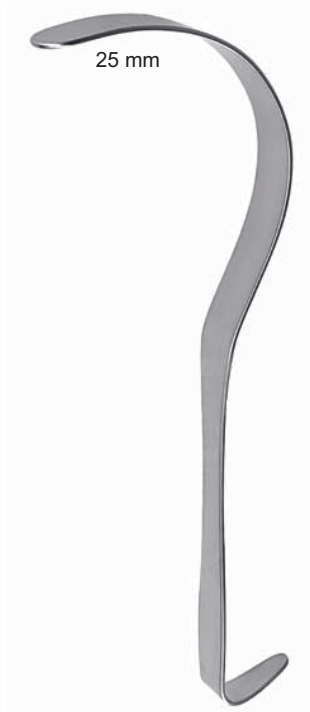

25 mm

**DEAVER**  
30,0 cm, 11<sup>3</sup>/<sub>4</sub>"  
KI-6901-72



25 mm

**DEAVER**  
33,0 cm, 13"  
KI-6901-73



25 mm

**DEAVER**  
36,0 cm, 14<sup>1</sup>/<sub>8</sub>"  
KI-6901-74



38 mm

**DEAVER**  
30,0 cm, 11<sup>3</sup>/<sub>4</sub>"  
KI-6901-75



50 mm

**DEAVER**  
30,0 cm, 11<sup>3</sup>/<sub>4</sub>"  
KI-6901-76



75 mm

**DEAVER**  
30,0 cm, 11<sup>3</sup>/<sub>4</sub>"  
KI-6901-77

# General Surgery Instruments



"Supporting Healthcare"  
**KAAHA INDUSTRIES**  
 Manufacturer Of Dental & Surgical Instruments

Wundhaken  
 Retractors  
 Separadores  
 Divaricatori

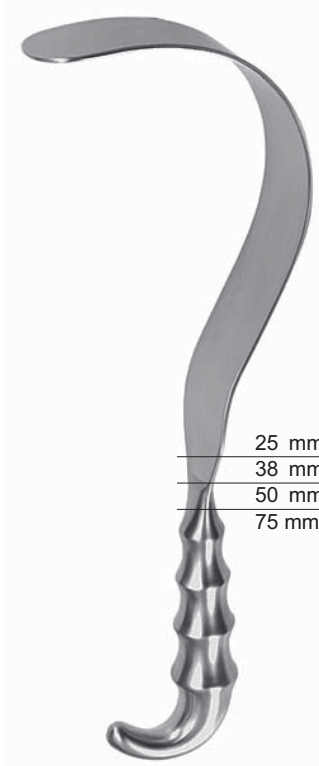

25 mm	<b>KI-6901-78</b>
38 mm	<b>KI-6901-79</b>
50 mm	<b>KI-6901-80</b>
75 mm	<b>KI-6901-81</b>

**DEAVER GRIP**  
 30,0 cm, 11<sup>3</sup>/<sub>4</sub>"



**ALLISON**

40 mm	30,0 cm, 11 <sup>3</sup> / <sub>4</sub> "	<b>KI-6901-82</b>
54 mm	32,0 cm, 12 <sup>1</sup> / <sub>2</sub> "	<b>KI-6901-83</b>



**DAVIDSON**

75 x 50 mm	16,0 cm, 6 <sup>1</sup> / <sub>4</sub> "	<b>KI-6901-84</b>
75 x 90 mm	16,0 cm, 6 <sup>1</sup> / <sub>4</sub> "	<b>KI-6901-85</b>



**ST MARKS**

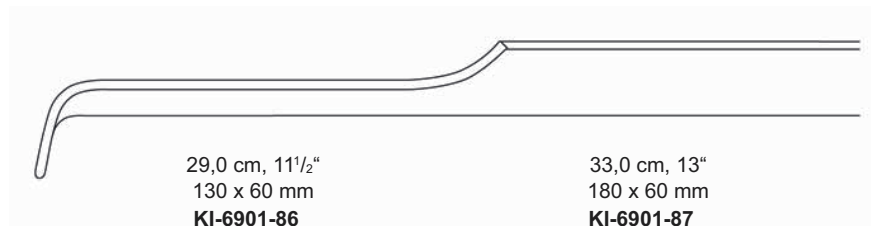

29,0 cm, 11<sup>1</sup>/<sub>2</sub>"  
 130 x 60 mm  
**KI-6901-86**

33,0 cm, 13"  
 180 x 60 mm  
**KI-6901-87**



29,0 cm, 11<sup>1</sup>/<sub>2</sub>"  
 130 x 60 mm  
**KI-6901-88**

33,0 cm, 13"  
 180 x 60 mm  
**KI-6901-89**





“Supporting Healthcare”

**KAAHA INDUSTRIES**

Manufacturer Of Dental & Surgical Instruments



**C8**

**184 to 208**

**Wundspreizer**

**Self-Retaining Retractors**

**Separadores con retenida automática**

**Divaricatori autostatici**

**Wundspreizer**  
**Self-Retaining Retractors**  
**Separadores con retenida automática**  
**Divaricatori autostatici**



5,0 cm, 2"  
**KI-7101-01**



5,0 cm, 2"  
**KI-7101-02**



7,0 cm, 2<sup>3</sup>/<sub>4</sub>"  
**KI-7101-03**



7,0 cm, 2<sup>3</sup>/<sub>4</sub>"  
**KI-7101-04**

scharf  
 sharp  
 agudos  
 acuti

stumpf  
 blunt  
 romo  
 smusso



**FINSEN**



**JANSEN**  
 10,0 cm, 4"

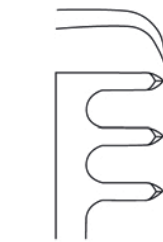

**KI-7101-05**  
 scharf  
 sharp  
 agudos  
 acuti

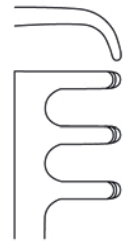

**KI-7101-06**  
 stumpf  
 blunt  
 romo  
 smusso



**ALM**

scharf  
 sharp  
 agudos  
 acuti

halbscharf  
 semi-sharp  
 semi-agudos  
 semi-acuti

stumpf  
 blunt  
 romo  
 smusso



7,0 cm, 2 <sup>3</sup> / <sub>4</sub> "	<b>KI-7101-07</b>	<b>KI-7101-09</b>	<b>KI-7101-11</b>
10,0 cm, 4"	<b>KI-7101-08</b>	<b>KI-7101-10</b>	<b>KI-7101-12</b>



**ALLPORT**  
 9,5 cm, 3<sup>3</sup>/<sub>4</sub>"  
**KI-7101-13**

**Wundspreizer**  
**Self-Retaining Retractors**  
**Separadores con retenida automática**  
**Divaricatori autostatici**

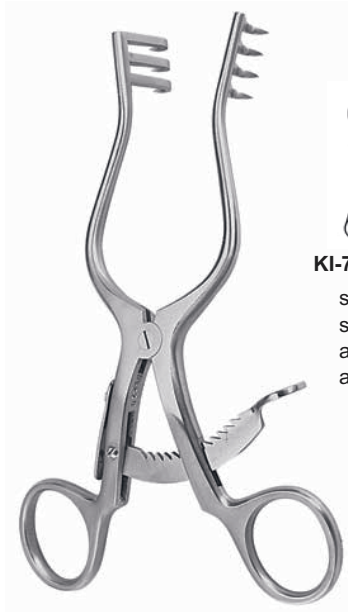

**SALP-CONTOUR**  
 14,0 cm, 5 1/2"



**KI-7101-14**  
 scharf  
 sharp  
 agudos  
 acuti



**KI-7101-15**  
 stumpf  
 blunt  
 romo  
 smusso

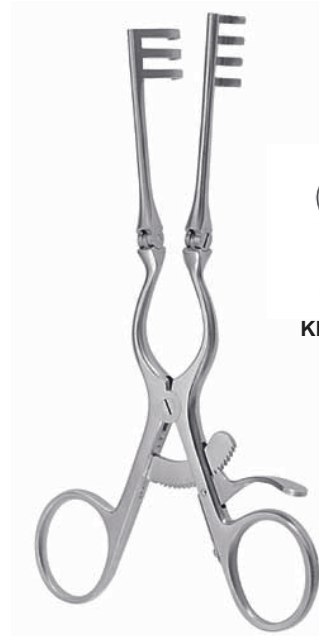

**ADSON-BABY**  
 16,0 cm, 6 1/4"



**KI-7101-16**  
 scharf  
 sharp  
 agudos  
 acuti



**KI-7101-17**  
 stumpf  
 blunt  
 romo  
 smusso



**ANDERSON-ADSON**  
 20,0 cm, 8"



**KI-7101-18**  
 scharf  
 sharp  
 agudos  
 acuti



**KI-7101-19**  
 stumpf  
 blunt  
 romo  
 smusso

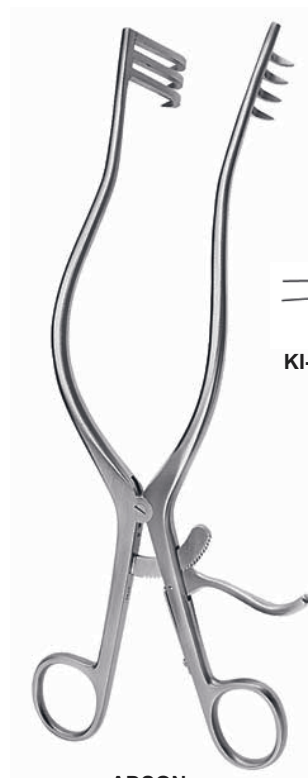

**ADSON**  
 26,5 cm, 10 1/2"



**KI-7101-20**  
 scharf  
 sharp  
 agudos  
 acuti



**KI-7101-21**  
 stumpf  
 blunt  
 romo  
 smusso

**Wundspreizer**  
**Self-Retaining Retractors**  
**Separadores con retenida automática**  
**Divaricatori autostatici**



**MOLLISON**  
 15,5 cm, 6"  
 KI-7101-22



scharf  
 sharp  
 agudos  
 acuti



**SCHUHKNECHT**  
 12,5 cm, 5"



**KI-7101-23**  
 scharf  
 sharp  
 agudos  
 acuti



**KI-7101-24**  
 stumpf  
 blunt  
 romo  
 smusso



**WULLSTEIN**



scharf  
 sharp  
 agudos  
 acuti

stumpf  
 blunt  
 romo  
 smusso

10,5 cm, 4 <sup>1</sup> / <sub>8</sub> "	<b>KI-7101-25</b>	<b>KI-7101-29</b>
13,0 cm, 5"	<b>KI-7101-26</b>	<b>KI-7101-30</b>
15,0 cm, 6"	<b>KI-7101-27</b>	<b>KI-7101-31</b>
18,0 cm, 7"	<b>KI-7101-28</b>	<b>KI-7101-32</b>

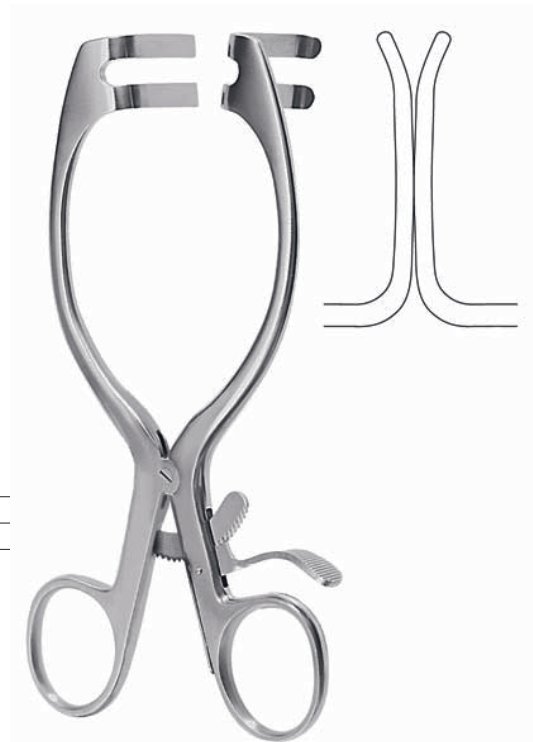

**MAYO-ADAMS**  
 16,5 cm, 6<sup>1</sup>/<sub>2</sub>"  
 KI-7101-33

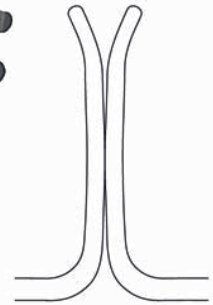

**Wundspreizer**  
**Self-Retaining Retractors**  
**Separadores con retenida automática**  
**Divaricatori autostatici**



**WEITLANER-LOKTITE**  
 10,5 cm, 4 1/8"



**KI-7101-34**  
 scharf  
 sharp  
 agudos  
 acuti



**KI-7101-35**  
 stumpf  
 blunt  
 romo  
 smusso



**WEITLANER**  
 13,0 cm, 5"



**KI-7101-36**  
 scharf  
 sharp  
 agudos  
 acuti



**KI-7101-37**  
 stumpf  
 blunt  
 romo  
 smusso



**WEITLANER**  
 16,5 cm, 6 1/2"



**KI-7101-38**  
 scharf  
 sharp  
 agudos  
 acuti



**KI-7101-39**  
 stumpf  
 blunt  
 romo  
 smusso



**WEITLANER**  
 20,0 cm, 8"



**KI-7101-40**  
 scharf  
 sharp  
 agudos  
 acuti



**KI-7101-41**  
 stumpf  
 blunt  
 romo  
 smusso

Wundspreizer  
 Self-Retaining Retractors  
 Separadores con retenida automática  
 Divaricatori autostatici



**WEITLANER**  
 24,0 cm, 9½"



**KI-7101-42**

scharf  
 sharp  
 agudos  
 acuti



**KI-7101-43**

stumpf  
 blunt  
 romo  
 smusso



**PLESTER**  
 13,0 cm, 5"



**KI-7101-44**

scharf  
 sharp  
 agudos  
 acuti



**KI-7101-45**

stumpf  
 blunt  
 romo  
 smusso



**MILLIGAN**  
 13,0 cm, 5"  
**KI-7101-46**

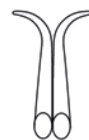
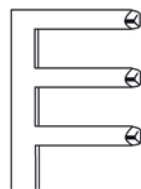

**PLESTER**  
 11,0 cm, 4¾"  
**KI-7101-47**

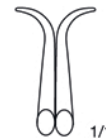

**PLESTER**  
 11,0 cm, 4¾"  
**KI-7101-48**



**WEITLANER-BABY**  
 13,0 cm, 5"  
 KI-7101-49



**ADSON  
 (CONE)**

**Wundspreizer**  
**Self-Retaining Retractors**  
**Separadores con retenida automática**  
**Divaricatori autostatici**

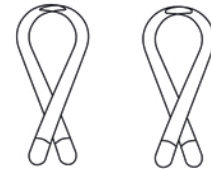

20,0 cm, 8" **KI-7101-50 KI-7101-51**  
 26,0 cm, 10 1/4" **KI-7101-52 KI-7101-53**

scharf	stumpf
sharp	blunt
agudos	romos
acuti	smusso



**GELPI**  
 13,5 cm, 5 3/8"  
 KI-7101-54



**GELPI**  
 19,0 cm, 7 1/2"  
 KI-7101-55



**GELPI-LOKTITE**  
 19,0 cm, 7 1/2"  
 KI-7101-56

Wundspreizer  
 Self-Retaining Retractors  
 Separadores con retenida automática  
 Divaricatori autostatici

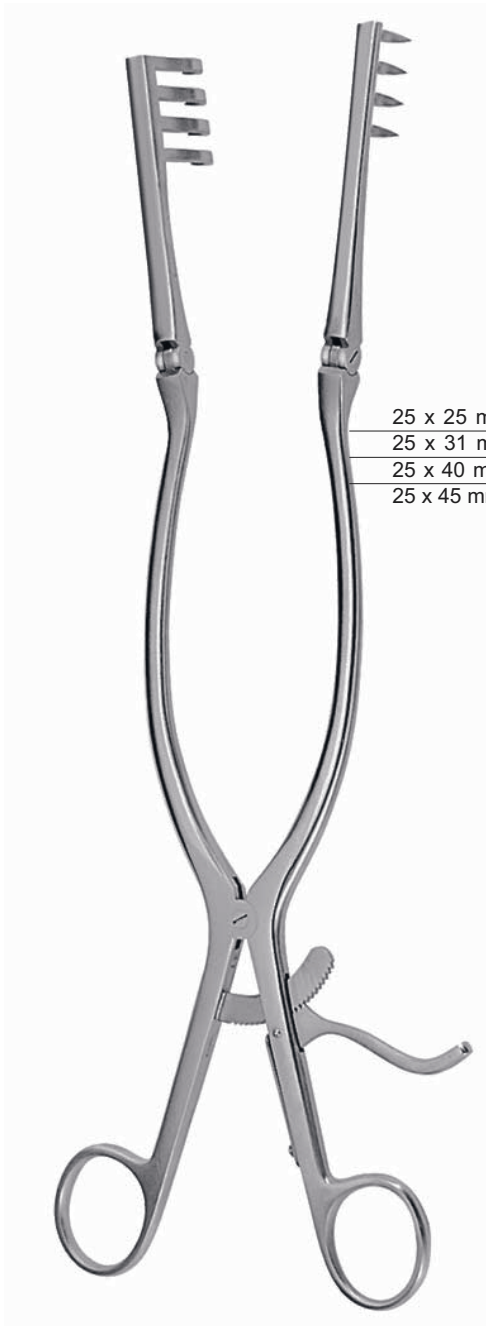

**BECKMANN-ADSON**  
 31,0 cm, 12 1/4"

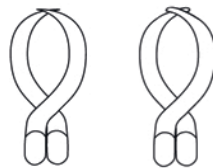

25 x 25 mm	<b>KI-7101-57</b>	<b>KI-7101-58</b>
25 x 31 mm	<b>KI-7101-59</b>	<b>KI-7101-60</b>
25 x 40 mm	<b>KI-7101-61</b>	<b>KI-7101-62</b>
25 x 45 mm	<b>KI-7101-63</b>	<b>KI-7101-64</b>

scharf	stumpf
sharp	blunt
agudos	romo
acuti	smusso

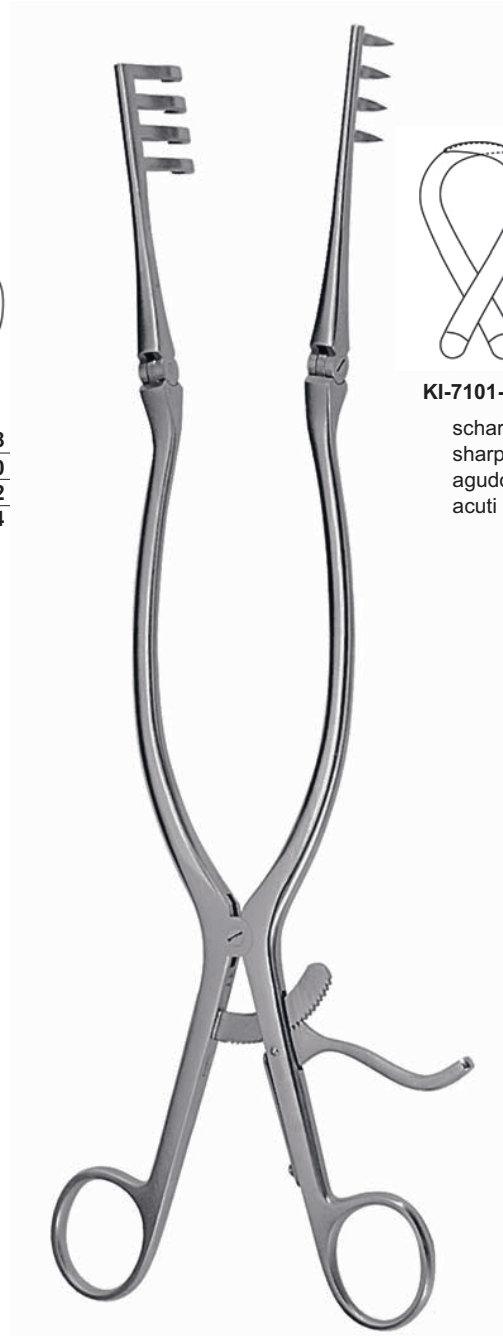

**BECKMANN**  
 31,0 cm, 12 1/4"



**KI-7101-65**  
 scharf  
 sharp  
 agudos  
 acuti



Wundspreizer  
Self-Retaining Retractors  
Separadores con retenida automática  
Divaricatori autostatici



**ADSON**  
32,0 cm, 12½"



**KI-7101-66**  
stumpf  
blunt  
romo  
smusso



**DE BAKEY**

10,0 cm, 4" **KI-7101-67**  
14,0 cm, 5½" **KI-7101-68**

Wundspreizer  
 Self-Retaining Retractors  
 Separadores con retenida automática  
 Divaricatori autostatici

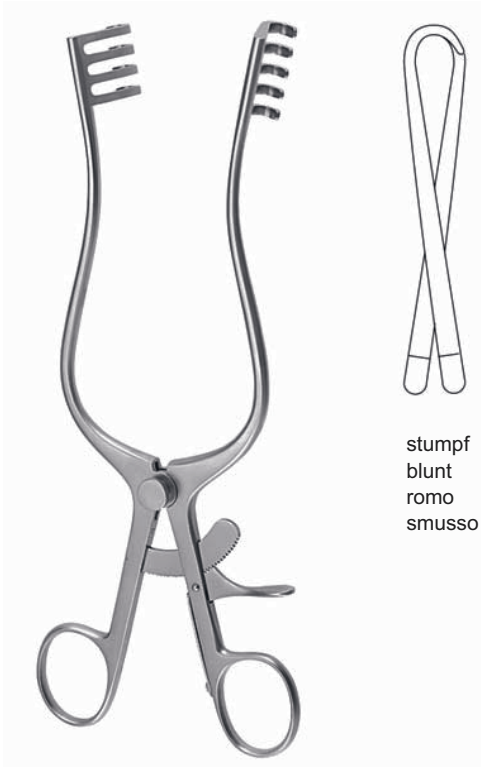

**NORFOLK AND NORWICH**  
 22,0 cm, 8<sup>5</sup>/<sub>8</sub>"  
 KI-7101-69

stumpf  
 blunt  
 romo  
 smusso

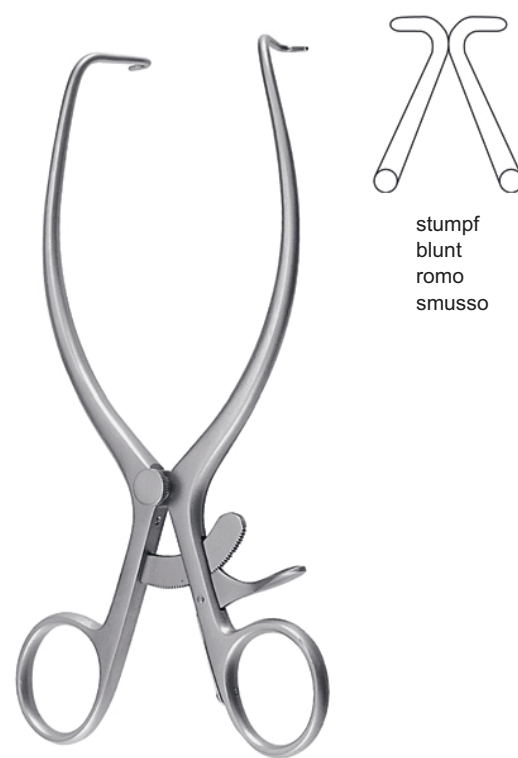

**JACKSON BURROWS**  
 17,5 cm, 7"  
 KI-7101-70

stumpf  
 blunt  
 romo  
 smusso



**RICHTER**  
 17,0 cm, 6<sup>3</sup>/<sub>4</sub>"  
 KI-7101-71



**JOLL (FRIEDMAN)**  
 15,5 cm, 6"  
 KI-7101-72

**Wundspreizer**  
**Self-Retaining Retractors**  
**Separadores con retenida automática**  
**Divaricatori autostatici**

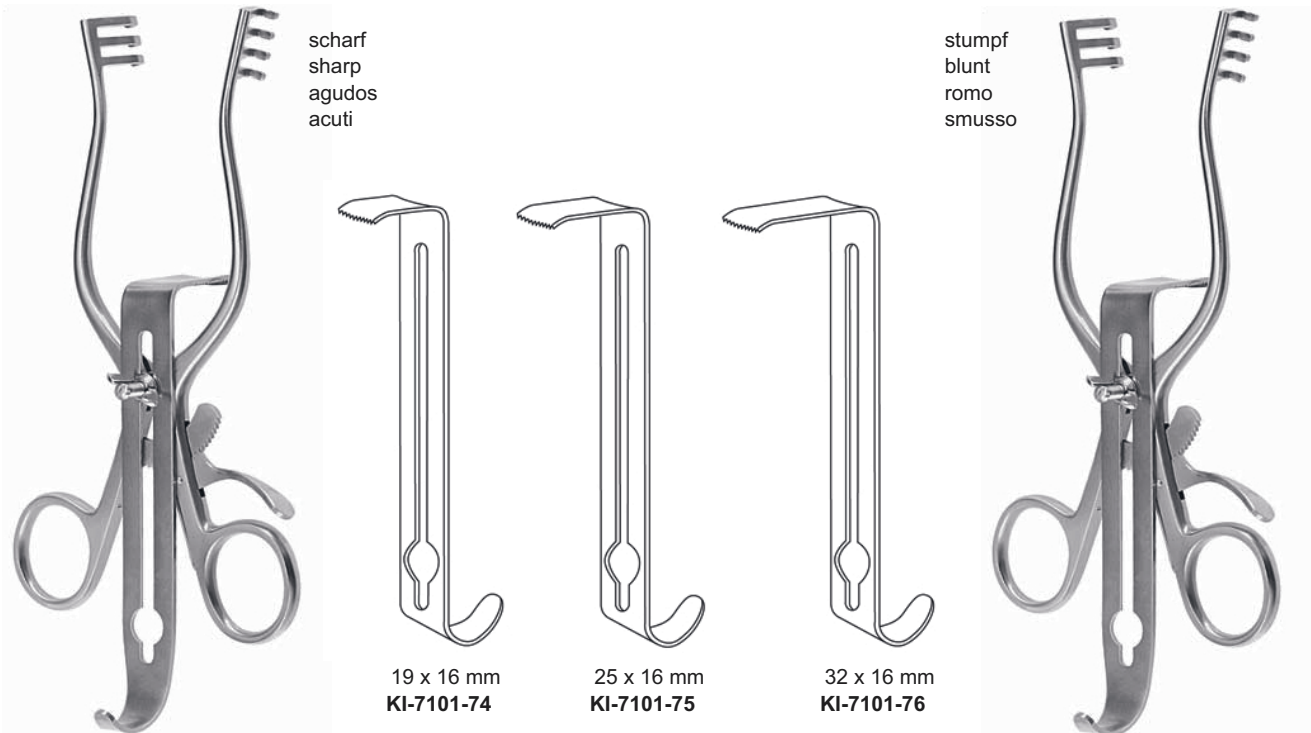

scharf  
sharp  
agudos  
acuti

stumpf  
blunt  
romo  
smusso

**HENLEY**  
16,0 cm, 6 1/4"  
**KI-7101-73**

**HENLEY**  
16,0 cm, 6 1/4"  
**KI-7101-77**

**HENLEY**  
**KI-7101-78**

- komplett, bestehend aus:  
 1 Sperrer mit Seitenvalven, scharf (070-300-16)  
 1 Mittelvalve 19 x 16 mm (070-300-19)  
 1 Mittelvalve 25 x 16 mm (070-300-25)  
 1 Mittelvalve 32 x 16 mm (070-300-32)

- complete, consisting of:  
 1 Spreader with lateral valves, sharp (070-300-16)  
 1 Central valve 19 x 16 mm (070-300-19)  
 1 Central valve 25 x 16 mm (070-300-25)  
 1 Central valve 32 x 16 mm (070-300-32)

- completo, compuesto of:  
 1 Separador con valvas laterales, agudas (070-300-16)  
 1 Valva central 19 x 16 mm (070-300-19)  
 1 Valva central 25 x 16 mm (070-300-25)  
 1 Valva central 32 x 16 mm (070-300-32)

- completo, composto da:  
 1 Divaricatore con valve laterali, acuto (070-300-16)  
 1 Valva centrale 19 x 16 mm (070-300-19)  
 1 Valva centrale 25 x 16 mm (070-300-25)  
 1 Valva centrale 32 x 16 mm (070-300-32)

**HENLEY**  
**KI-7101-79**

- komplett, bestehend aus:  
 1 Sperrer mit Seitenvalven, stumpf (070-301-16)  
 1 Mittelvalve 19 x 16 mm (070-300-19)  
 1 Mittelvalve 25 x 16 mm (070-300-25)  
 1 Mittelvalve 32 x 16 mm (070-300-32)

- complete, consisting of:  
 1 Spreader with lateral valves, blunt (070-301-16)  
 1 Central valve 19 x 16 mm (070-300-19)  
 1 Central valve 25 x 16 mm (070-300-25)  
 1 Central valve 32 x 16 mm (070-300-32)

- completo, compuesto of:  
 1 Separador con valvas laterales, romas (070-301-16)  
 1 Valva central 19 x 16 mm (070-300-19)  
 1 Valva central 25 x 16 mm (070-300-25)  
 1 Valva central 32 x 16 mm (070-300-32)

- completo, composto da:  
 1 Divaricatore con valve laterali, smusso (070-301-16)  
 1 Valva centrale 19 x 16 mm (070-300-19)  
 1 Valva centrale 25 x 16 mm (070-300-25)  
 1 Valva centrale 32 x 16 mm (070-300-32)

Wundspreizer, Bauchdeckenhalter  
 Self-Retaining Retractors, Abdominal Retractors  
 Separadores con retenida automática, Separadores abdominales  
 Divaricatori autostatici, Divaricatori addominali



**MAYO-ADAMS**  
 17,0 cm, 6<sup>3</sup>/<sub>4</sub>"  
 KI-7101-80



**COLLIN-BABY**  
 18,0 cm, 7"  
 KI-7101-81

30 x 44 mm  
 KI-7101-82



23 x 44 mm  
 KI-7101-83

Wechselvalven  
 Exchangeable blades  
 Valvas intergambiabiles  
 Valve intercambiabili



**RICARD**  
 28,0 cm, 11"  
 KI-7101-84

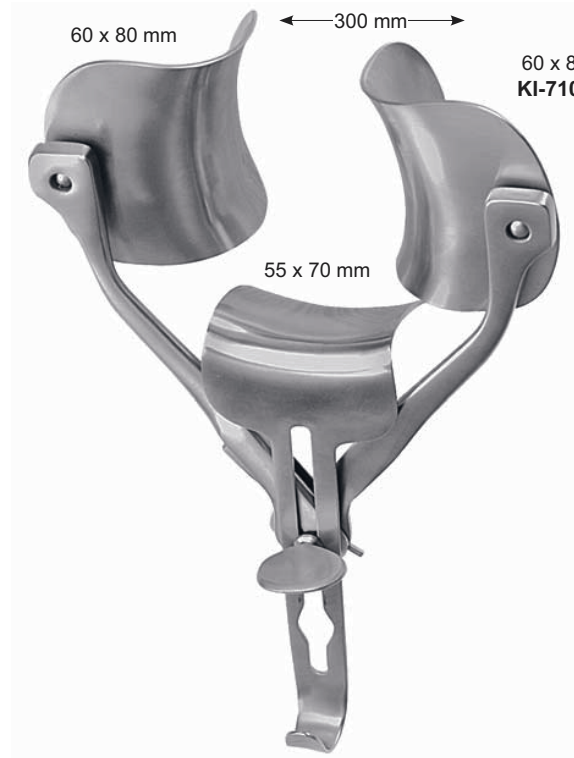

**RICARD**  
 30,0 cm, 12"  
 KI-7101-86

**Wundspreizer, Bauchdeckenhalter**  
**Self-Retaining Retractors, Abdominal Retractors**  
**Separadores con retenida automática, Separadores abdominales**  
**Divaricatori autostatici, Divaricatori addominali**



**COLLIN**  
 23,5 cm, 9 1/4"  
**KI-7101-88**



**COLLIN**  
 23,5 cm, 9 1/4"  
**KI-7101-90**



**COLLIN**  
 23,5 cm, 9 1/4"  
**KI-7101-92**

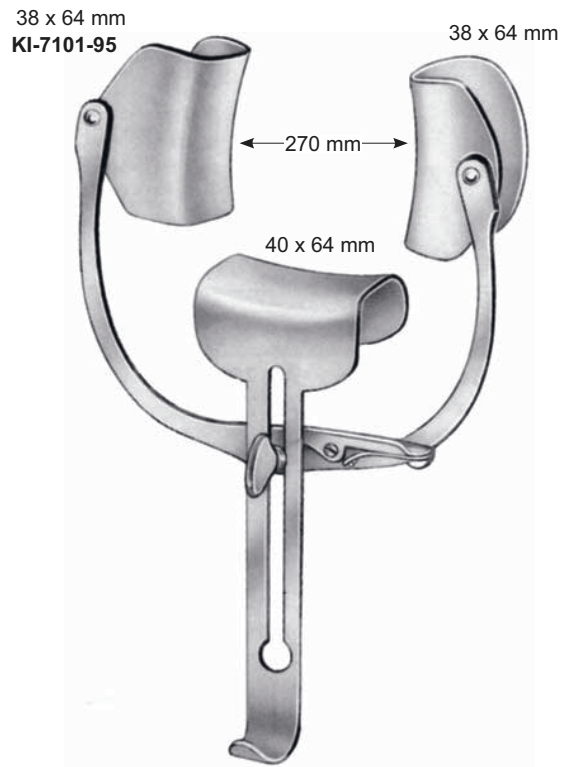

**ROBIN-MASSÉ**  
**KI-7101-94**

Wundspreizer, Bauchdeckenhalter  
 Self-Retaining Retractors, Abdominal Retractors  
 Separadores con retenida automática, Separadores abdominales  
 Divaricatori autostatici, Divaricatori addominali

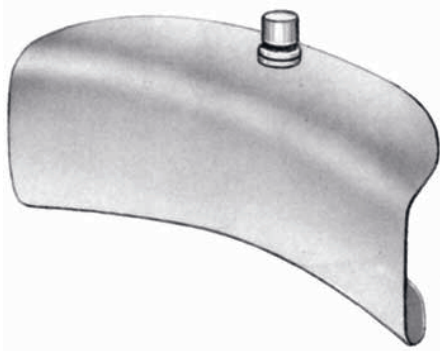

38 x 62 mm **KI-7101-96**  
 40 x 80 mm **KI-7101-97**  
 60 x 80 mm **KI-7101-98**

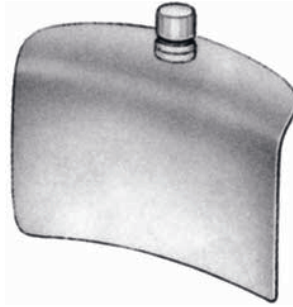

50 x 58 mm **KI-7101-99**  
 60 x 80 mm **KI-7201-01**  
 72 x 85 mm **KI-7201-02**

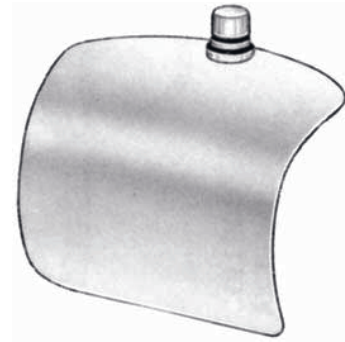

**KI-7201-03**  
 60 x 80 mm

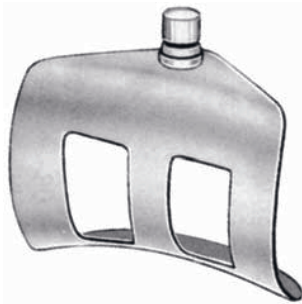

**KI-7201-04**  
 60 x 80 mm



58 x 50 mm **KI-7201-05**  
 80 x 60 mm **KI-7201-06**  
 85 x 72 mm **KI-7201-07**



62 x 38 mm **KI-7201-08**  
 80 x 38 mm **KI-7201-09**  
 100 x 38 mm **KI-7201-10**  
 80 x 38 mm **KI-7201-11**



**COLLIN**  
 55 x 55 mm **KI-7201-12**  
 55 x 65 mm **KI-7201-13**  
 55 x 75 mm **KI-7201-14**



**ROBIN-MASSÉ**  
 40 x 64 mm **KI-7201-15**  
 55 x 65 mm **KI-7201-16**  
 55 x 75 mm **KI-7201-17**



**RICARD**  
 65 x 50 mm **KI-7201-18**  
 70 x 55 mm **KI-7201-19**  
 90 x 80 mm **KI-7201-20**

Bauchdeckenhalter  
Abdominal Retractors  
Separadores abdominales  
Divaricatori addominali

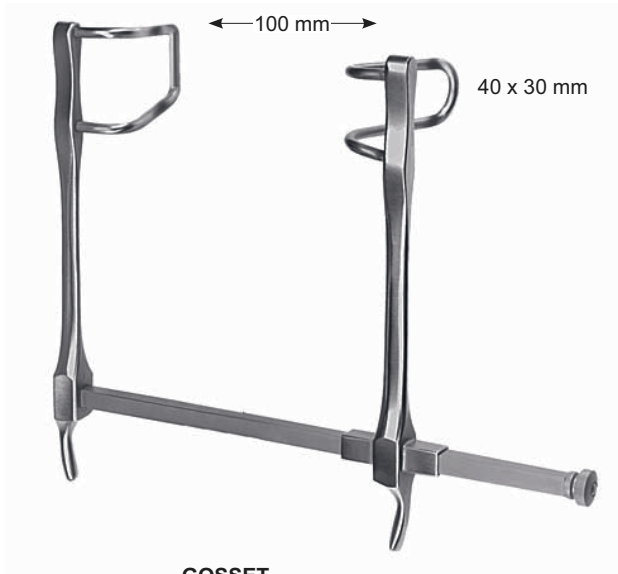

**GOSSET**  
KI-7201-21



**GOSSET**  
KI-7201-22



**GOSSET**  
KI-7201-23



**ABADIE**  
KI-7201-24

Bauchdeckenhalter  
 Abdominal Retractors  
 Separadores abdominales  
 Divaricatori addominali

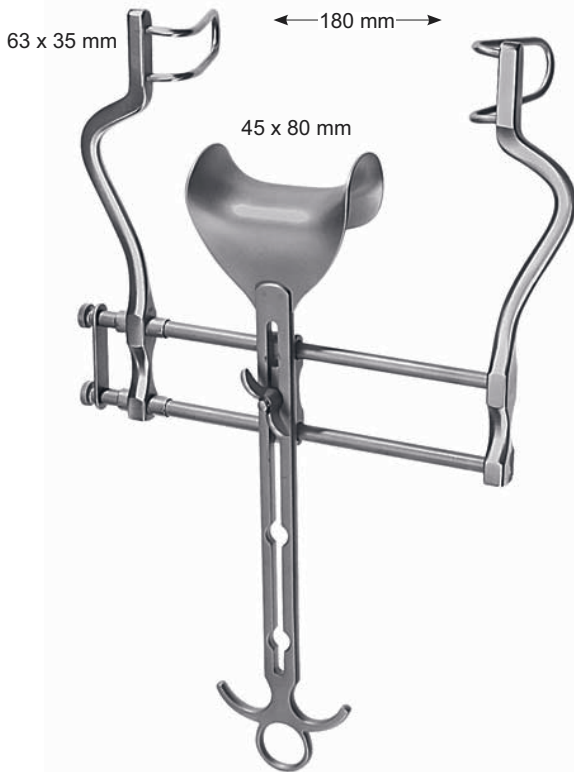

**BALFOUR**  
 KI-7201-25

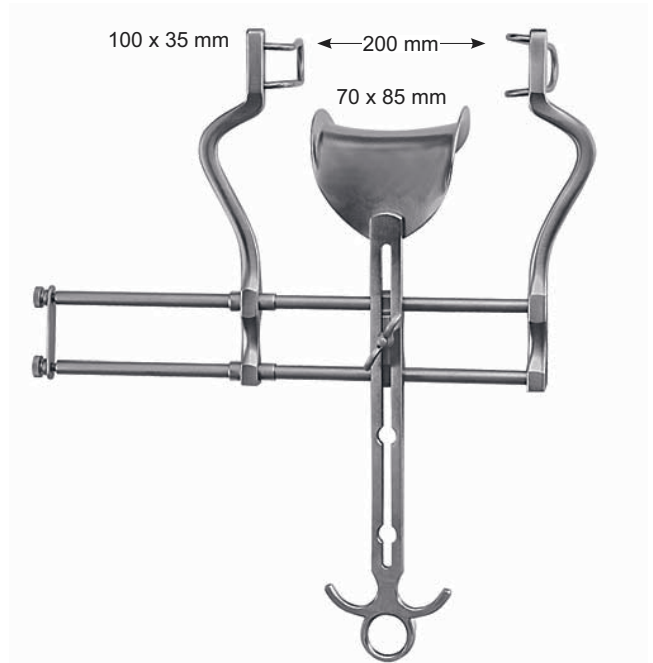

**BALFOUR**  
 KI-7201-26

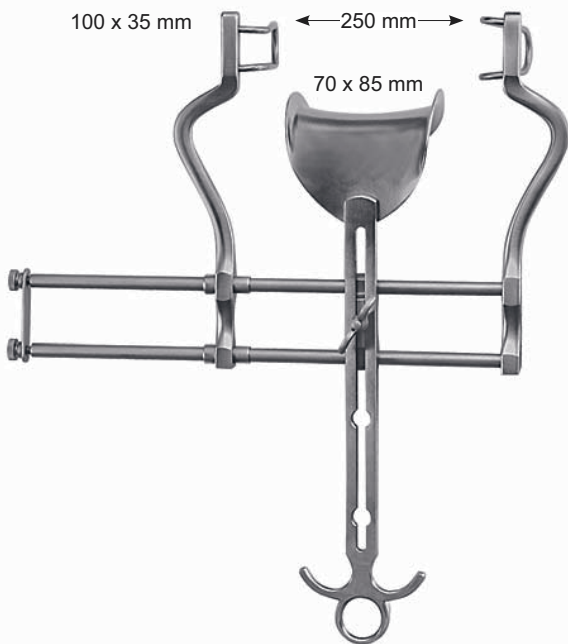

**BALFOUR**  
 KI-7201-27

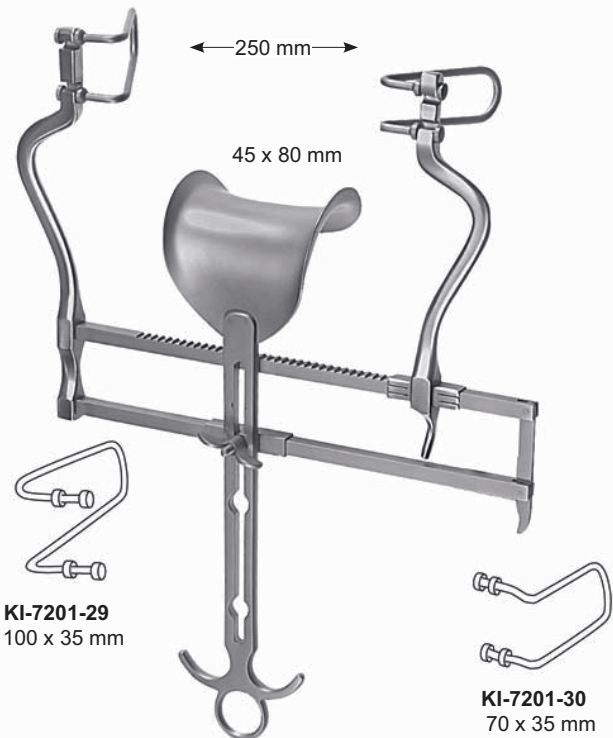

**BALFOUR US-TYPE**  
 KI-7201-28



Bauchdeckenhalter  
 Abdominal Retractors  
 Separadores abdominales  
 Divaricatori addominali



**BALFOUR**  
 100 x 70 mm  
 KI-7201-31

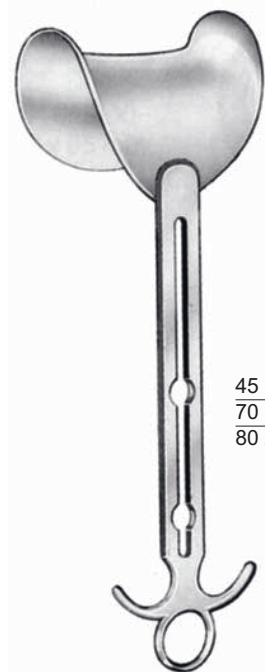

**BALFOUR**

45 x 80 mm **KI-7201-32**  
 70 x 85 mm **KI-7201-33**  
 80 x 90 mm **KI-7201-34**

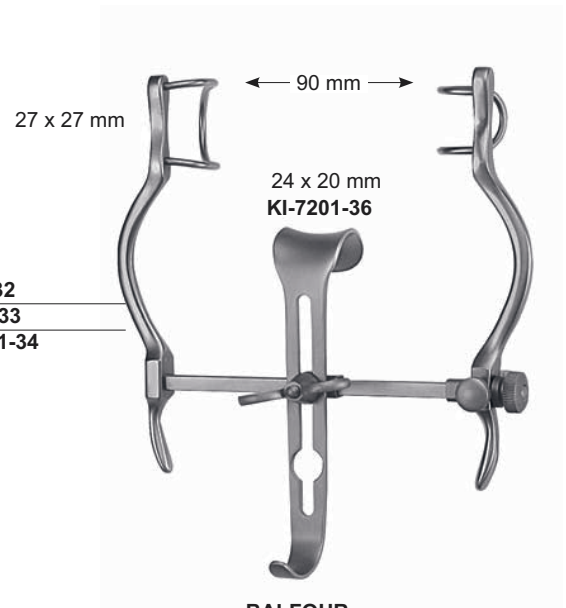

**BALFOUR**  
 KI-7201-35



**BERKELEY**  
 KI-7201-37

35 x 60 mm  
**KI-7201-38**

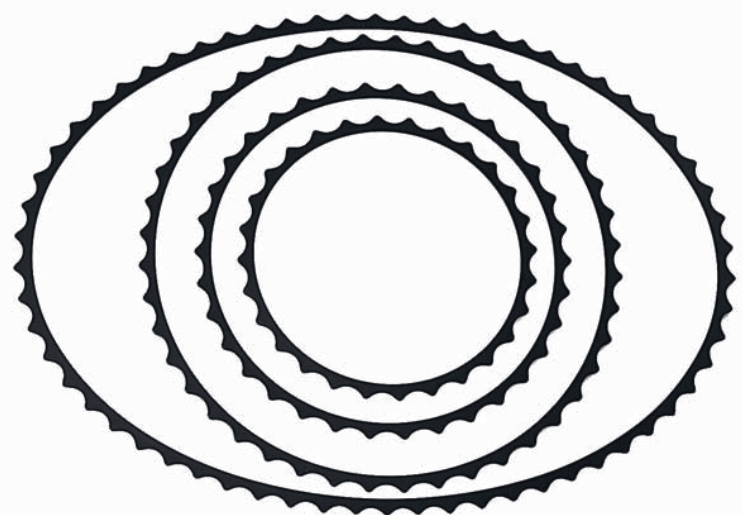

**TURNER-WARNICK**  
 modifiziert

Ø 180 mm, 7" **KI-7201-39**  
 Ø 230 mm, 9" **KI-7201-40**  
 Ø 305 mm, 12" **KI-7201-41**  
 455 x 330 mm **KI-7201-42**

Bauchdeckenhalter  
Abdominal Retractors  
Separadores abdominales  
Divaricatori addominali

geschwärzt, black fi nish, negra, nera



**KI-7201-43**  
13 mm



**KI-7201-44**  
51 x 38 mm



**KI-7201-45**  
70 x 60 mm



**KI-7201-46**  
89 x 60 mm



**KI-7201-47**  
114 x 60 mm

## TURNER-WARNICK modifiziert

geschwärzt, black fi nish, negra, nera



**KI-7201-48**  
19 x 76 mm



**KI-7201-49**  
38 x 102 mm



**KI-7201-50**  
57 x 89 mm



**KI-7201-51**  
57 x 114 mm

Bauchdeckenhalter  
 Abdominal Retractors  
 Separadores abdominales  
 Divaricatori addominali

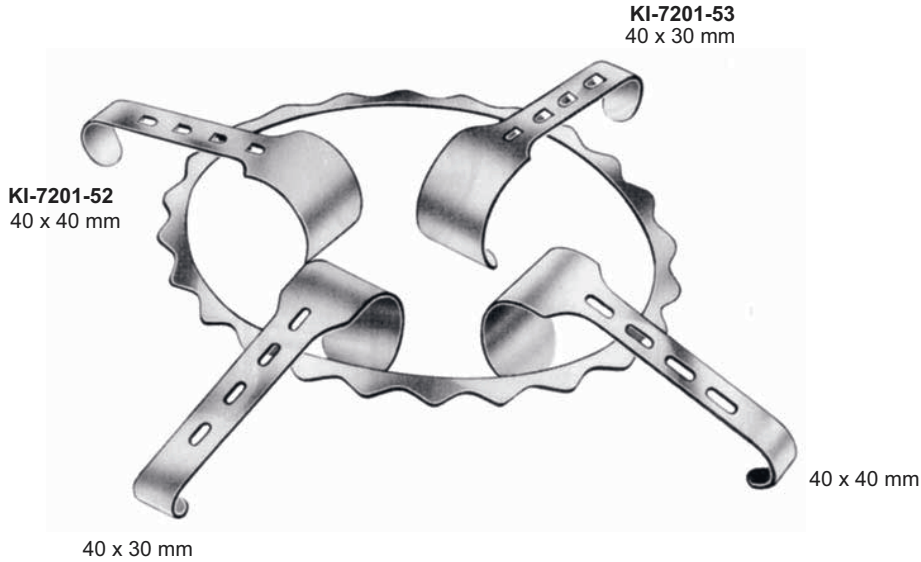

**KI-7201-54**  
 255 x 180 mm  
 Rahmen allein  
 frame only  
 cuadro suelto  
 solo telaio

**DENNIS BROWN**  
 255 x 180 mm  
**KI-7201-55**  
 komplett complete  
 completo completo

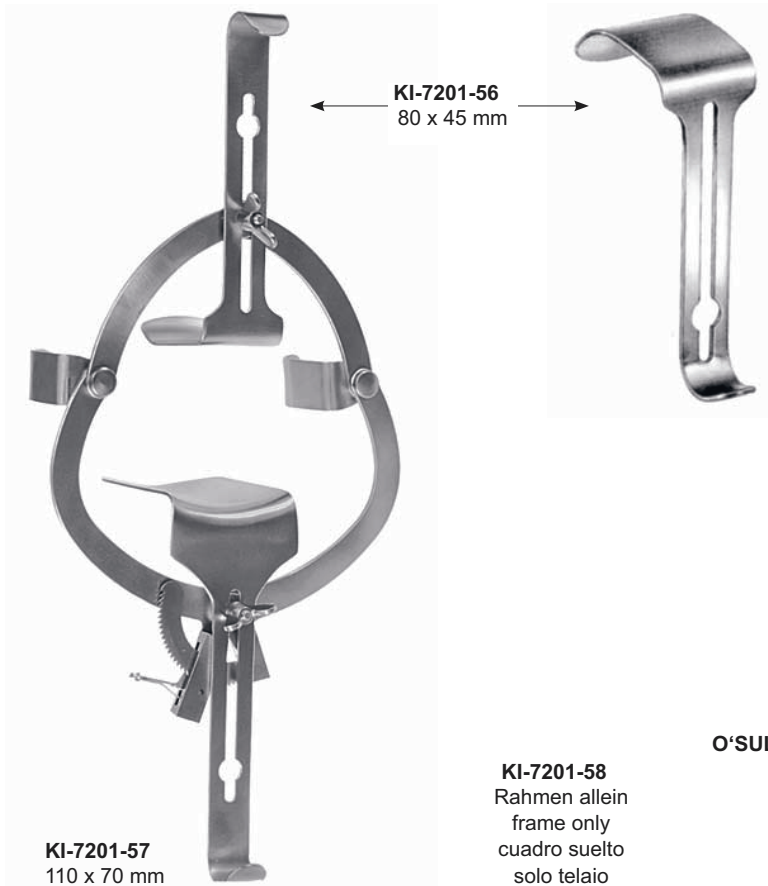

Bauchdeckenhalter  
 Abdominal Retractors  
 Separadores abdominales  
 Divaricatori addominali

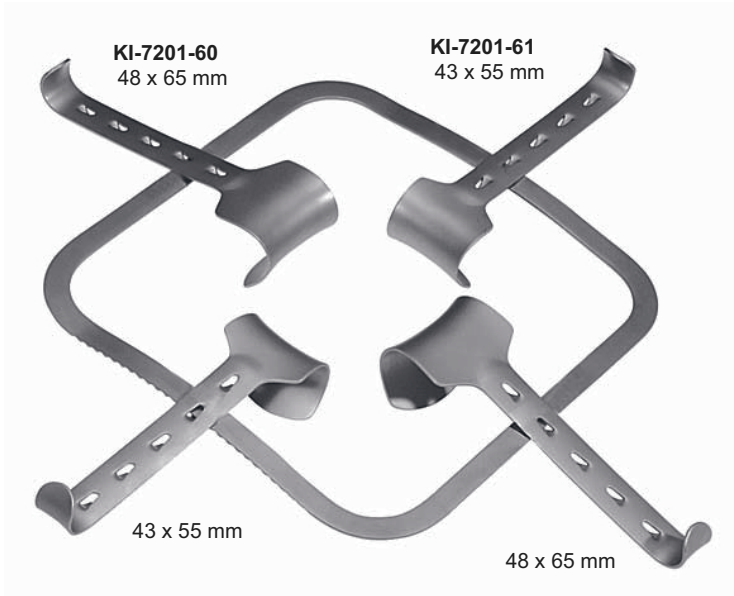

**KI-7201-62** 250 x 250 mm  
**KI-7201-63** 300 x 320 mm  
**KI-7201-64** 300 x 380 mm  
 Rahmen allein  
 frame only  
 cuadro suelto  
 solo telaio

**KIRSCHNER**  
**KI-7201-65**  
 komplett  
 complete  
 completo  
 completo  
 1 x 074-880-01  
 2 x 074-880-13  
 2 x 074-880-14



**KI-7201-66**  
 255 x 255 mm  
 zusammenlegbarer Rahmen, allein  
 folding frame, only  
 cuadro plegable, suelto  
 telaio pieghevole, solo

**KIRSCHNER**  
**KI-7201-67**  
 komplett  
 complete  
 completo  
 completo  
 1 x 074-882-01  
 2 x 074-880-13  
 2 x 074-880-14



43 x 55 mm **KI-7201-68**  
 48 x 65 mm **KI-7201-69**  
 80 x 90 mm **KI-7201-70**  
 90 x 65 mm **KI-7201-71**  
 98 x 95 mm **KI-7201-72**

**KIRSCHNER**

Bauchdeckenhalter  
 Abdominal Retractors  
 Separadores abdominales  
 Divaricatori addominali



**KIRSCHNER**  
 60 x 82 mm  
 KI-7201-73



**KIRSCHNER-BALFOUR**  
 83 x 82 mm  
 KI-7201-74



**KIRSCHNER**  
 98 x 51 mm **KI-7201-75**  
 105 x 38 mm **KI-7201-76**

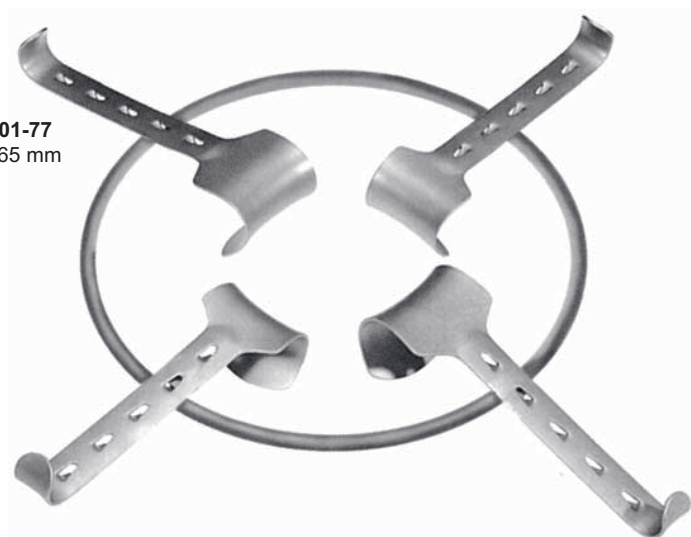

**KI-7201-77**  
 48 x 65 mm

**KI-7201-78**  
 300 x 240 mm  
 Rahmen allein  
 frame only  
 cuadro suelto  
 solo telaio

**KI-7201-79**  
 80 x 90 mm

**KIRSCHNER, oval**  
**KI-7201-80**  
 komplett, complete, completo, completo  
 1 x 074-884-01  
 3 x 074-880-14  
 1 x 074-880-15  
 1 x 074-880-20  
 1 x 074-880-21



**KIRSCHNER**  
 98 x 51 mm **KI-7201-81**  
 105 x 38 mm **KI-7201-82**

# General Surgery Instruments



"Supporting Healthcare"  
**KAAHA INDUSTRIES**  
 Manufacturer Of Dental & Surgical Instruments

Bauchdeckenhalter  
 Abdominal Retractors  
 Separadores abdominales  
 Divaricatori addominali



**KI-7201-85**  
76 x 98 mm



**KI-7201-86**  
47 x 65 mm



**KI-7201-87**  
98 x 52 mm



**KI-7201-88**  
105 x 35 mm

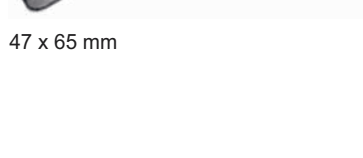

**KI-7201-83**  
275 x 250 mm  
Rahmen allein  
frame only  
cuadro suelto  
solo telaio

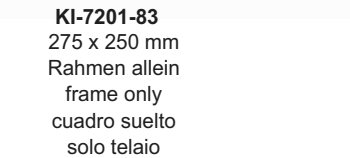

**KI-7201-84**  
50 x 54 mm



**KI-7201-91**  
38 x 60 mm



**KI-7201-92**  
300 x 300 mm  
zusammenlegbarer Rahmen, allein  
folding frame, only  
cuadro plegable, suelto  
telaio pieghevole, solo



**KI-7201-90**  
50 x 65 mm

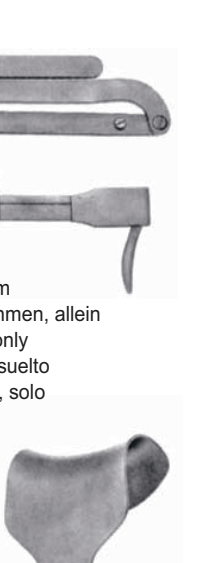

**FRANZ**  
**KI-7201-89**  
 komplett  
 complete  
 completo  
 completo  
 1 x 031-1900-01  
 2 x 031-1900-11  
 2 x 031-1900-13

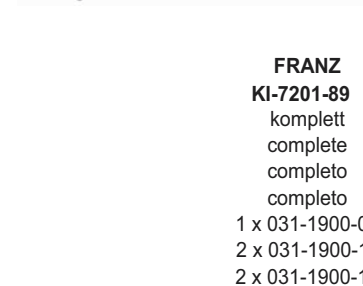

38 x 60 mm **KI-7201-93**  
45 x 80 mm **KI-7201-94**



50 x 65 mm **KI-7201-95**  
60 x 85 mm **KI-7201-96**

**Bauchdeckenhalter**  
**Abdominal Retractors**  
**Separadores abdominales**  
**Divaricatori addominali**

für / for / para / per  
 031-1910-11  
 031-1910-14



95 x 60 mm	<b>KI-7201-97</b>
105 x 65 mm	<b>KI-7201-98</b>
115 x 65 mm	<b>KI-7201-99</b>
125 x 65 mm	<b>KI-7301-01</b>

**DOYEN**  
 28,0 cm, 11"



Kette mit Gewicht  
 Chain with weight  
 Cadena con pesa  
 Catena con peso

**KI-7301-02**  
 78,5 cm, 31"



53,0 cm, 21"

66,0 cm, 26"

Befestigungsgestell  
 Mounting frame  
 Bastidor para la fijación  
 Telaio di supporto per il fissaggio

**ROCHARD**  
**KI-7301-03**



53,0 cm, 21"

66,0 cm, 26"

Befestigungsgestell  
 Mounting frame  
 Bastidor para la fijación  
 Telaio di supporto per il fissaggio

**ROCHARD**  
**KI-7301-04**



**ROCHARD**  
 28,0 cm, 11"  
**KI-7301-05**

95 x 48 mm	<b>KI-7301-06</b>
105 x 48 mm	<b>KI-7301-07</b>
115 x 48 mm	<b>KI-7301-08</b>
125 x 48 mm	<b>KI-7301-09</b>
155 x 48 mm	<b>KI-7301-10</b>

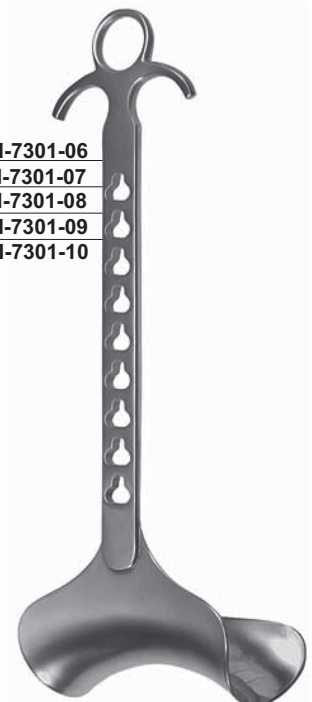

**ROCHARD**  
 28,0 cm, 11"

Bauchspatel  
 Abdominal Spatulas  
 Espátulas abdominales  
 Spatole addominali



biegsam  
 malleable  
 maleable  
 malleabile

- 200 x 6 mm **KI-7301-11**
- 200 x 12 mm **KI-7301-12**
- 200 x 17 mm **KI-7301-13**
- 200 x 20 mm **KI-7301-14**
- 200 x 25 mm **KI-7301-15**



biegsam  
 malleable  
 maleable  
 malleabile

- 330 x 13 mm **KI-7301-16**
- 330 x 25 mm **KI-7301-17**
- 330 x 32 mm **KI-7301-18**
- 330 x 40 mm **KI-7301-19**
- 330 x 50 mm **KI-7301-20**

**RIBBON**



biegsam  
 malleable  
 maleable  
 malleabile

- 280 x 25/30 mm **KI-7301-21**
- 300 x 37/45 mm **KI-7301-22**
- 300 x 40/50 mm **KI-7301-23**

**RIBBON**

**RIBBON**



biegsam  
 malleable  
 maleable  
 malleabile

**TUFFIER**  
 200 x 25/17 mm  
**KI-7301-24**



**REVERDIN**  
 280 x 45/60 mm  
**KI-7301-25**



Rippensperrer  
 Rib Spreaders  
 Separadores costales  
 Divaricatori costali

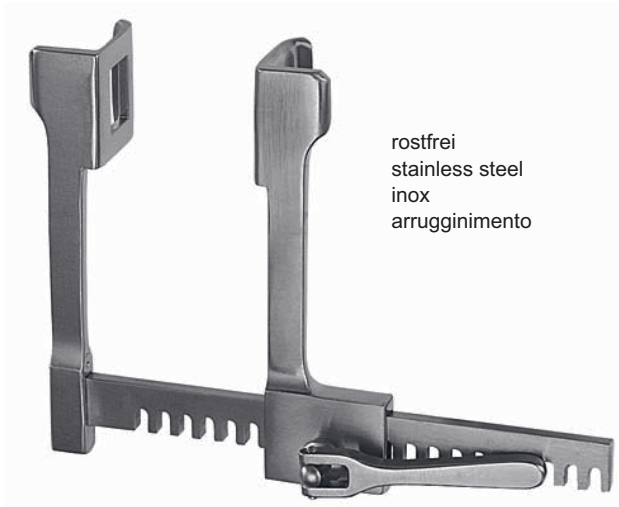

rostfrei  
 stainless steel  
 inox  
 arrugginimento

**FINOCCHIETTO-BABY**

a	b	c	
18 mm	20 mm	75 mm	<b>KI-7301-26</b>

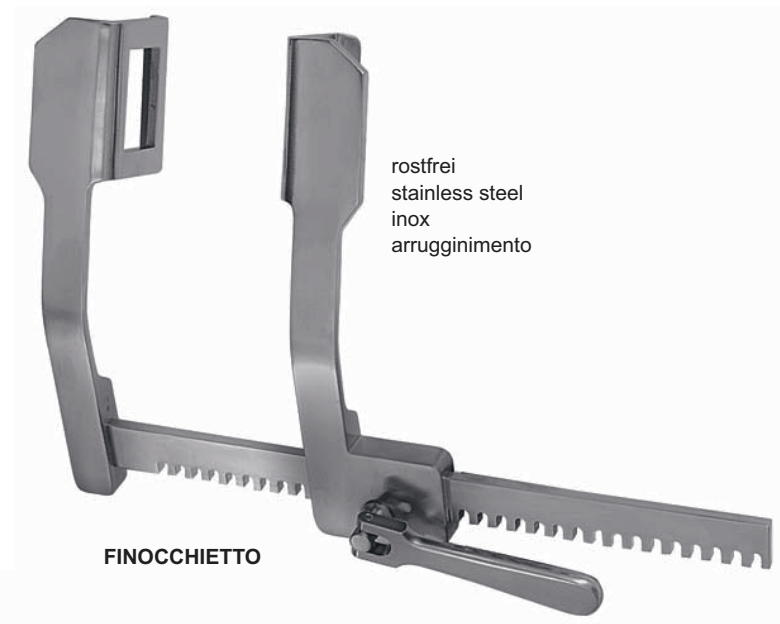

rostfrei  
 stainless steel  
 inox  
 arrugginimento

**FINOCCHIETTO**

a	b	c	
40 mm	40 mm	165 mm	<b>KI-7301-27</b>
45 mm	65 mm	200 mm	<b>KI-7301-28</b>
70 mm	65 mm	250 mm	<b>KI-7301-29</b>



rostfrei  
 stainless steel  
 inox  
 arrugginimento

**TUFFIER**

a	b	c	
50 mm	45 mm	165 mm	<b>KI-7301-30</b>

Sonden  
 Probes  
 Sondas  
 Sonde



Ø 1,0 mm	Ø 2,0 mm
11,5 cm, 4 1/2" <b>KI-7301-31</b>	<b>KI-7301-37</b>
13,0 cm, 5" <b>KI-7301-32</b>	<b>KI-7301-38</b>
14,5 cm, 5 3/4" <b>KI-7301-33</b>	<b>KI-7301-39</b>
16,0 cm, 6 1/4" <b>KI-7301-34</b>	<b>KI-7301-40</b>
18,0 cm, 7" <b>KI-7301-35</b>	<b>KI-7301-41</b>
20,0 cm, 8" <b>KI-7301-36</b>	<b>KI-7301-42</b>

Ø 2,0 mm



11,5 cm, 4 1/2" <b>KI-7301-43</b>
13,0 cm, 5" <b>KI-7301-44</b>
14,5 cm, 5 3/4" <b>KI-7301-45</b>
16,0 cm, 6 1/4" <b>KI-7301-46</b>
18,0 cm, 7" <b>KI-7301-47</b>
20,0 cm, 8" <b>KI-7301-48</b>

Ø 1,0 mm



Silber  
 Silver  
 Plata  
 Argentó

**STACKE**  
 10,5 cm, 4 1/8"  
**KI-7301-49**



Myrtenblattsonden  
 Myrtle leaf probes  
 Sondas para mirto  
 Sonde a foglia di mirto

11,5 cm, 4 1/2" <b>KI-7301-50</b>
13,0 cm, 5" <b>KI-7301-51</b>
14,5 cm, 5 3/4" <b>KI-7301-52</b>
16,0 cm, 6 1/4" <b>KI-7301-53</b>
18,0 cm, 7" <b>KI-7301-54</b>
20,0 cm, 8" <b>KI-7301-55</b>

Ø 3,5 mm



**NÉLATON**  
 16,0 cm, 6 1/4"  
**KI-7301-56**



**DOYEN**  
 14,5 cm, 5 3/4"  
**KI-7301-57**



**BRODIE**  
 20,0 cm, 8"  
**KI-7301-58**

Sonden  
 Probes  
 Sondas  
 Sonde

Ø 3,5 mm



11,5 cm, 4 1/2"	<b>KI-7301-59</b>
13,0 cm, 5"	<b>KI-7301-60</b>
14,5 cm, 5 3/4"	<b>KI-7301-61</b>
16,0 cm, 6 1/4"	<b>KI-7301-62</b>
18,0 cm, 7"	<b>KI-7301-63</b>
20,0 cm, 8"	<b>KI-7301-64</b>

Ø 3,3 mm



13,0 cm, 5"	<b>KI-7301-65</b>
14,5 cm, 5 3/4"	<b>KI-7301-66</b>
16,0 cm, 6 1/4"	<b>KI-7301-67</b>
18,0 cm, 7"	<b>KI-7301-68</b>



**LOCKHAKI-MUMMERY**  
 16,5 cm, 6 1/2"  
**KI-7301-69**



**LOCKHAKI-MUMMERY**  
 16,5 cm, 6 1/2"  
**KI-7301-70**

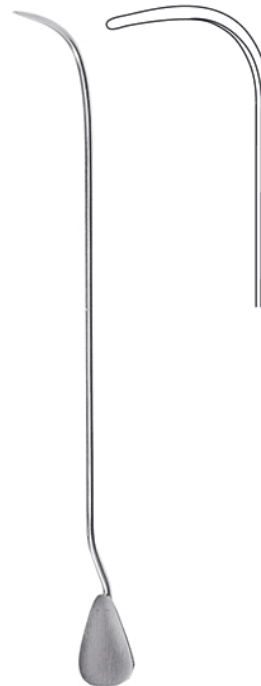

**LOCKHAKI-MUMMERY**  
 16,5 cm, 6 1/2"  
**KI-7301-71**



**LOCKHAKI-MUMMERY**  
 16,5 cm, 6 1/2"  
**KI-7301-72**

Watteträger  
 Cotton Applicators  
 Porta-algodones  
 Porta-cotone



**FEIN**  
 28,0 cm, 11"  
 KI-7301-73



**UKERMANN**  
 16,0 cm, 6 1/4"  
 KI-7301-74



**JOBSON-HORNE**  
 18,0 cm, 7"  
 KI-7301-75



**FARRELL**  
 (LATHBURY)

- 12,0 cm, 4 3/4" **KI-7301-76** Ø 0,9 mm
- 14,0 cm, 5 3/4" **KI-7301-77** Ø 0,9 mm
- 16,5 cm, 6 1/4" **KI-7301-78** Ø 1,1 mm
- 18,0 cm, 7" **KI-7301-79** Ø 1,2 mm



**FARRELL**

- 12,0 cm, 4 3/4" **KI-7301-80** Ø 0,9 mm
- 14,0 cm, 5 3/4" **KI-7301-81** Ø 0,9 mm
- 16,5 cm, 6 1/4" **KI-7301-82** Ø 1,1 mm
- 18,0 cm, 7" **KI-7301-83** Ø 1,2 mm

**Krampfader-Besteck**  
**Varicose Vein Probe Set**  
**Juego para várices**  
**Astuccio per varici**



**NABATOFF**  
**KI-7301-84**  
 komplett  
 complete  
 completo  
 completo

**KI-7301-85**  
 Metalletui  
 Metal case  
 Estuche de metal  
 Scatola in metallo

135 x 100 x 25 mm



Ø 3,0 mm  
**KI-7301-86**



Ø 6,0 mm  
**KI-7301-87**



Ø 9,0 mm  
**KI-7301-88**



Ø 12,0 mm  
**KI-7301-89**



**KI-7301-90**  
 Zugseil  
 Cable  
 Cable  
 Fune

**KI-7301-91**  
 Kunststoff-Sondenspitze  
 Plastic probe tip  
 Extremidad de sonda de plástico  
 Punta in materia plastica

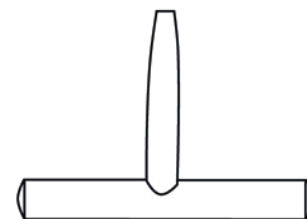

**KI-7301-92**  
 Handgriff  
 Handle  
 Mango  
 Manico

# General Surgery Instruments



"Supporting Healthcare"  
**KAAHA INDUSTRIES**  
 Manufacturer Of Dental & Surgical Instruments

Trokare  
 Trocars  
 Trócares  
 Trequarti



Ø 3,0 mm	<b>KI-7301-93</b>
Ø 3,5 mm	<b>KI-7301-94</b>
Ø 4,0 mm	<b>KI-7301-95</b>
Ø 4,5 mm	<b>KI-7301-96</b>
Ø 5,0 mm	<b>KI-7301-97</b>
Ø 5,5 mm	<b>KI-7301-98</b>
Ø 6,0 mm	<b>KI-7301-99</b>

**STANDARD**  
 11,0 cm, 4<sup>3</sup>/<sub>8</sub>"



Ø 3,0 mm	<b>KI-7401-01</b>
Ø 3,5 mm	<b>KI-7401-02</b>
Ø 4,0 mm	<b>KI-7401-03</b>
Ø 4,5 mm	<b>KI-7401-04</b>
Ø 5,0 mm	<b>KI-7401-05</b>
Ø 5,5 mm	<b>KI-7401-06</b>
Ø 6,0 mm	<b>KI-7401-07</b>

**STANDARD**  
 12,0 cm, 4<sup>3</sup>/<sub>4</sub>"



Ø 3,0 mm	<b>KI-7401-08</b>
Ø 3,5 mm	<b>KI-7401-09</b>
Ø 4,0 mm	<b>KI-7401-10</b>
Ø 4,5 mm	<b>KI-7401-11</b>
Ø 5,0 mm	<b>KI-7401-12</b>
Ø 5,5 mm	<b>KI-7401-13</b>
Ø 6,0 mm	<b>KI-7401-14</b>

**STANDARD**  
 12,0 cm, 4<sup>3</sup>/<sub>4</sub>"



Ø 7,3 mm	<b>KI-7401-15</b>
Ø 8,7 mm	<b>KI-7401-16</b>
Ø 12,0 mm	<b>KI-7401-17</b>

**HURWITZ**



Ø 4,5 mm    Ø 3,0 mm    Ø 1,75 mm

**UNIVERSAL**  
**KI-7401-18**

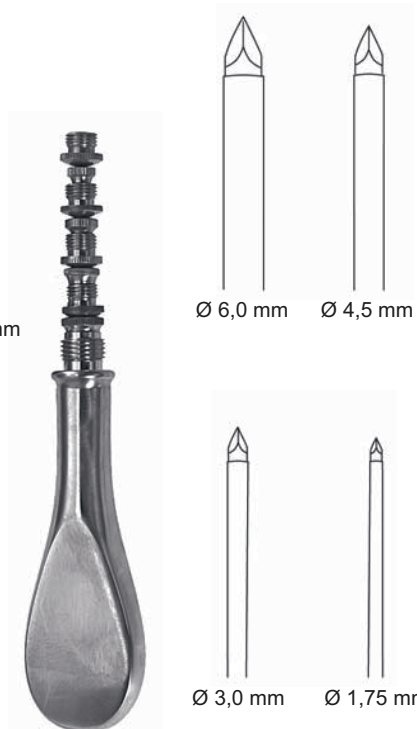

Ø 6,0 mm    Ø 4,5 mm

Ø 3,0 mm    Ø 1,75 mm

**UNIVERSAL**  
**KI-7401-19**

# General Surgery Instruments



"Supporting Healthcare"  
**KAAHA INDUSTRIES**  
 Manufacturer Of Dental & Surgical Instruments

Trokare  
 Trocars  
 Trócares  
 Trequarti



**UNIVERSAL**  
 KI-7401-20



**UNIVERSAL**  
 KI-7401-21

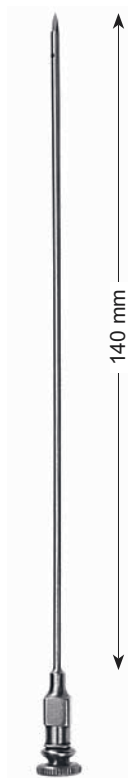

**LANDAU**  
 Ø 2,0 mm  
 KI-7401-22



**LANDAU**  
 Ø 2,0 mm  
 KI-7401-23



**DAVIDSON**  
 Ø 6,0 mm  
 KI-7401-24



**BUELAU**  
 Ø 8,0 mm  
 KI-7401-25

Trokare  
 Trocars  
 Trócares  
 Treuanti



Ø 2,0 mm	<b>KI-7401-26</b>
Ø 2,5 mm	<b>KI-7401-27</b>
Ø 3,0 mm	<b>KI-7401-28</b>

**LERMOYEZ**



Ø 6,0 mm	<b>KI-7401-29</b>
Ø 8,0 mm	<b>KI-7401-30</b>

**CAMPBELL**  
 16,0 cm, 6 1/4"

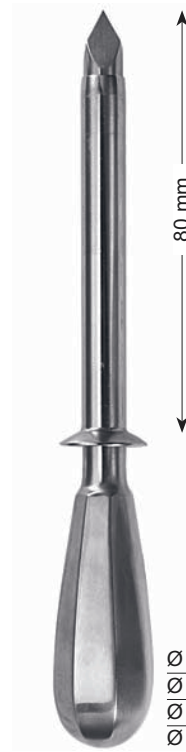

80 mm

Ø 7,5 mm	<b>KI-7401-31</b>
Ø 9,0 mm	<b>KI-7401-32</b>
Ø 10,5 mm	<b>KI-7401-33</b>
Ø 12,0 mm	<b>KI-7401-34</b>

**NELSON**  
 21,0 cm, 8 1/2"

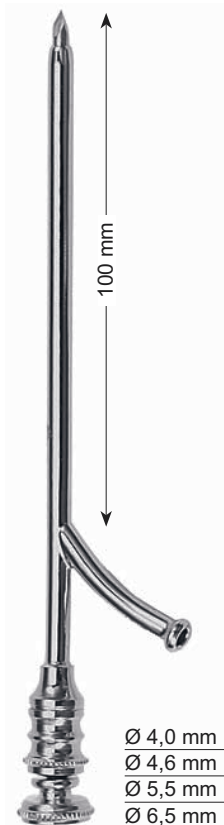

100 mm

Ø 4,0 mm	<b>KI-7401-35</b>
Ø 4,6 mm	<b>KI-7401-36</b>
Ø 5,5 mm	<b>KI-7401-37</b>
Ø 6,5 mm	<b>KI-7401-38</b>

**OCHSNER**  
 14,0 cm, 5 1/2"



Record Konus  
 Record cone

Ø 3,0 mm	<b>KI-7401-39</b>
Ø 4,0 mm	<b>KI-7401-40</b>
Ø 5,0 mm	<b>KI-7401-41</b>

**PIERCE**  
 16,0 cm, 6 1/4"

Ø 2,25 mm



**COAKLEY**  
 14,0 cm, 5 1/4"  
**KI-7401-42**





Ø 4,0 mm

**KRAUSE**  
 16,0 cm, 6¼"

**LICHTWITZ**  
 Kieferhöhlentrokare  
 Antrum trocars  
 Trócares para el seno maxilar  
 Trequarti per puntura del seno mascellare

Ø 1,8 mm

- Ø 3,0 mm    **KI-7401-43**
- Ø 4,0 mm    **KI-7401-44**
- Ø 5,0 mm    **KI-7401-45**
- Ø 5,5 mm    **KI-7401-46**



**LICHTWITZ**  
 20,0 cm, 8"  
**KI-7401-47**

**Trokare, Saugrohre**  
**Trocars, Suction Tubes**  
**Trócares, Tubos para aspiración**  
**Trequarti, Tubi aspirazione**

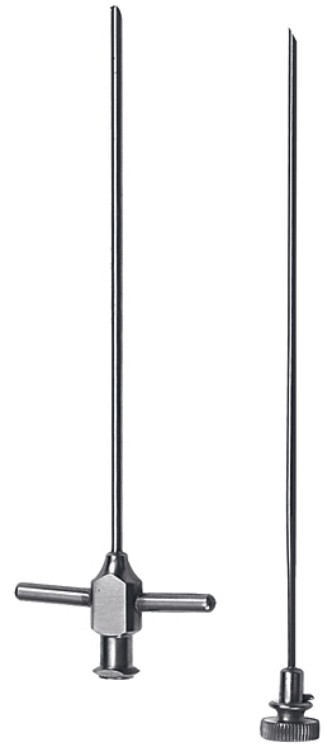

**LICHTWITZ**  
 11,0 cm, 4½"  
**KI-7401-48**



**DOUGLAS**  
 Ø 3,0 mm  
**KI-7401-49**



**POOLE**  
 22,0 cm, 8⅝"

- Ø 6,0 mm    **KI-7401-50**
- Ø 10,0 mm    **KI-7401-51**



**POOLE**  
 22,0 cm, 8⅝"

- Ø 6,0 mm    **KI-7401-52**
- Ø 8,0 mm    **KI-7401-53**

Saugrohre  
 Suction Tubes  
 Tubos para aspiración  
 Tubi aspirazione

auswechselbare Spitze  
 interchangeable tip  
 punta intercambiabile  
 tipo intercambiabile



Ø 3,5 mm  
 KI-7401-55



KI-7401-57  
 Olive allein  
 Olive only  
 Oliva suelto  
 Olivo solo



**COUPLAND**  
 17,0 cm, 6<sup>3</sup>/<sub>4</sub>"  
 KI-7401-54



**YANKAUER**  
 27,0 cm, 10<sup>5</sup>/<sub>8</sub>"  
 KI-7401-56

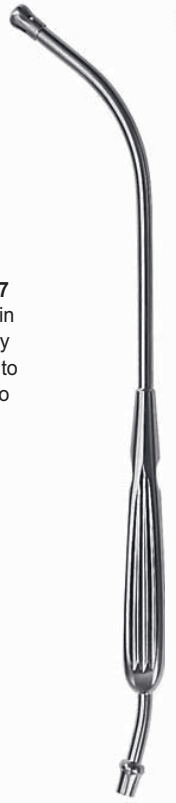

**DE BAKEY**  
 27,0 cm, 10<sup>5</sup>/<sub>8</sub>"  
 KI-7401-58



**ANTHONY**  
 26,0 cm, 10<sup>1</sup>/<sub>4</sub>"  
 KI-7401-59



**ANDREWS-PYNCHON**  
 24,0 cm, 9<sup>1</sup>/<sub>2</sub>"  
 KI-7401-60



**COOLEY**  
 35,0 cm, 13<sup>3</sup>/<sub>4</sub>"  
 Ø 8,0 mm  
 KI-7401-61



**COOLEY**  
 30,0 cm, 11<sup>3</sup>/<sub>4</sub>"  
 Ø 7,0 mm  
 KI-7401-62



**COOLEY**  
 31,0 cm, 11<sup>3</sup>/<sub>4</sub>"  
 Ø 10,0 mm  
 KI-7401-63



**COOLEY**  
 33,0 cm, 13"  
 Ø 8,0 mm  
 KI-7401-64

Ø 2,0 mm



**COGSWELL**  
 23,0 cm, 9"  
 KI-7401-65

# General Surgery Instruments



"Supporting Healthcare"  
**KAAHA INDUSTRIES**  
 Manufacturer Of Dental & Surgical Instruments

Saugrohre  
 Suction Tubes  
 Tubos para aspiración  
 Tubi aspirazione



**BYRD**  
 20,0 cm, 8"

- Ø 1,5 mm **KI-7401-66**
- Ø 2,5 mm **KI-7401-67**
- Ø 3,5 mm **KI-7401-68**



**HEPP/SCHIEDL**  
 22,5 cm, 8<sup>3</sup>/<sub>4</sub>"  
**KI-7401-69**

Ø 4,0 mm



**ADSON**  
 21,0 cm, 8<sup>1</sup>/<sub>4</sub>"  
**KI-7401-70**



**MAGILL**  
 17,5 cm, 6<sup>5</sup>/<sub>8</sub>"

- Ø 1,0 mm **KI-7401-71**
- Ø 2,0 mm **KI-7401-72**
- Ø 3,0 mm **KI-7401-73**
- Ø 4,0 mm **KI-7401-74**



**FRAZIER**  
 19,0 cm, 7<sup>1</sup>/<sub>2</sub>"

- Charr. 6 **KI-7401-75**
- Charr. 8 **KI-7401-76**
- Charr. 10 **KI-7401-77**
- Charr. 12 **KI-7401-78**



**FERGUSSON**  
 18,0 cm, 7"

- Charr. 6 **KI-7401-79**
- Charr. 8 **KI-7401-80**
- Charr. 10 **KI-7401-81**
- Charr. 12 **KI-7401-82**



**POPPE**  
 13,0 cm, 5"

- Charr. 6 **KI-7401-83**
- Charr. 8 **KI-7401-84**
- Charr. 10 **KI-7401-85**
- Charr. 12 **KI-7401-86**



"Supporting Healthcare"

**KAAHA INDUSTRIES**

Manufacturer Of Dental & Surgical Instruments

**C10**

**220 to 229**



**Galle, Leber, Niere, Blase, Urologie**

**Gall, Liver, Kidney, Bladder, Urology**

**Bilis, Hígado, Riñon, Vejiga, Urología**

**Bile, Fegato, Rene, Vescica, Urologia**

Nierensteinzangen, Gallensteinzangen  
 Kidney Stone Forceps, Gall Stone Forceps  
 Pinzas para los cálculos renales, Pinzas para los cálculos biliares  
 Pinze per calcoli renali, Pinze per calcoli biliari



**RANDALL**



23,0 cm, 9"  
**KI-0100-01**

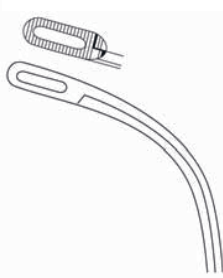

22,0 cm, 8<sup>5</sup>/<sub>8</sub>"  
**KI-0100-02**

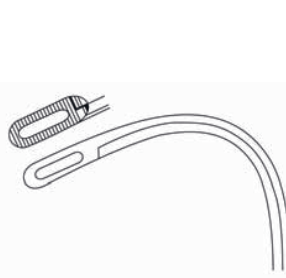

22,0 cm, 8<sup>5</sup>/<sub>8</sub>"  
**KI-0100-03**



22,0 cm, 8<sup>5</sup>/<sub>8</sub>"  
**KI-0100-04**



19,0 cm, 7<sup>1</sup>/<sub>2</sub>"  
**KI-0100-05**

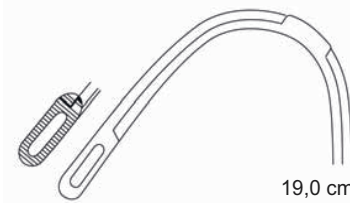

19,0 cm, 7<sup>1</sup>/<sub>2</sub>"  
**KI-0100-06**



**DESJARDINS**  
 23,0 cm, 9"



**KI-0100-07**



**KI-0100-08**



**MIXTER**  
 22,0 cm, 8<sup>5</sup>/<sub>8</sub>"  
**KI-0100-09**



**MAYO BLAKE**  
 20,0 cm, 8"  
**KI-0100-10**



20,0 cm, 8"  
**KI-0100-11**

Gallensteinzangen  
Gall Stone Forceps  
Pinzas para los cálculos biliares  
Pinze per calcoli biliari

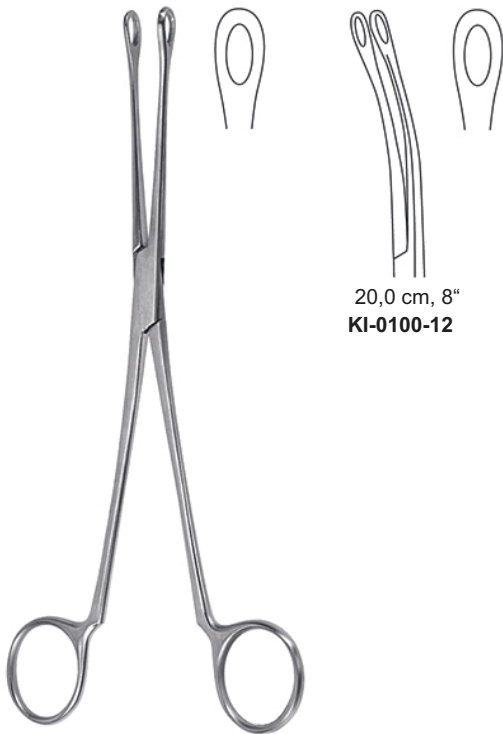

20,0 cm, 8"  
KI-0100-12

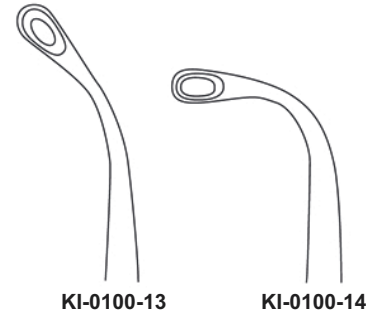

KI-0100-13

KI-0100-14

**BLAKE**  
20,0 cm, 8"  
KI-0100-15

**TURNER-WARWICK**  
18,0 cm, 7"

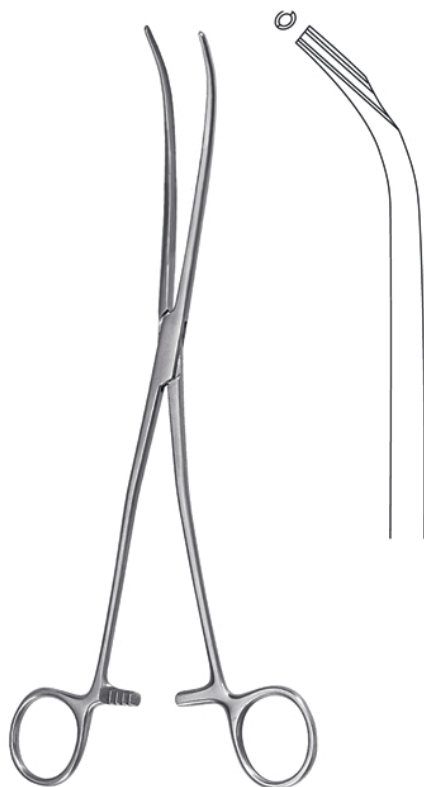

**SÖKELAND**  
24,0 cm, 9½"  
KI-0100-16

**CZERNY**  
24,5 cm, 9⅝"  
KI-0100-17

Gallensteinlöffel  
 Gall Stone Scoops  
 Cucharillas para los cálculos biliares  
 Cucchiari per calcoli biliari



**LUER-KÖRTE**  
 24,0 cm, 9½"

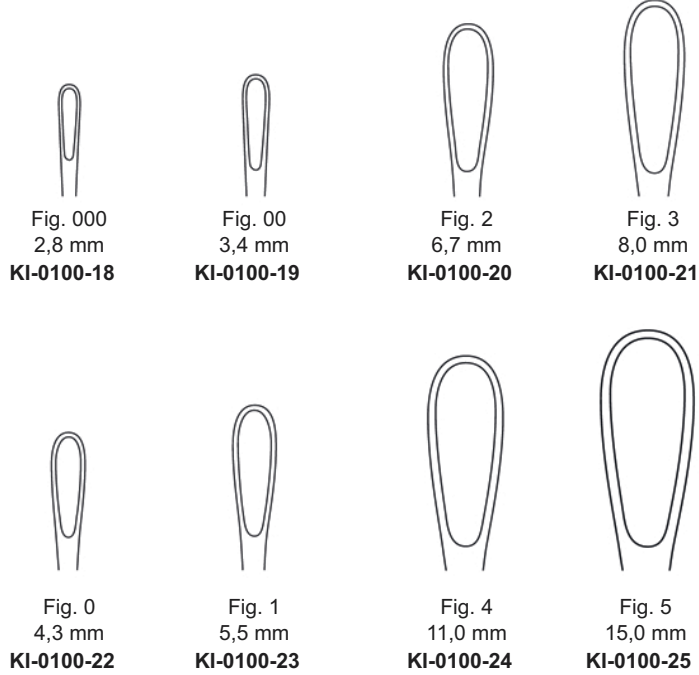

**FERGUSON**  
 21,5 cm, 8½"  
 KI-0100-26



**MAYO**  
 27,0 cm, 10⅝"  
 KI-0100-27

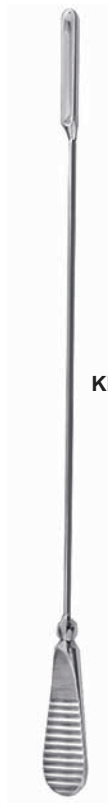

**MAYO**  
 27,0 cm, 10⅝"

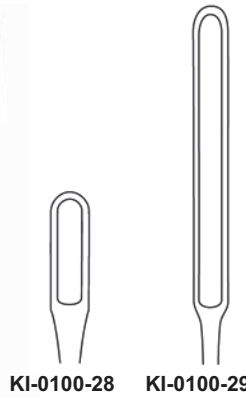

**MOYNIHAN**  
 34,0 cm, 13⅜"  
 KI-0100-30

Gallengangsonden, Gallengang Dilatoren  
 Gall Duct Probes, Common Bile Duct Dilators  
 Sonas p. el conducto biliar, Dilatadores para el conducto biliar  
 Dilatatori per condotti biliari, Dilatatori per coledoco



**MAYO**  
 32,0 cm, 12 1/2"  
 KI-0100-31



**OCHSNER**  
 35,0 cm, 13 3/4"  
 KI-0100-32



**DESJARDINS**  
 28,0 cm, 11"

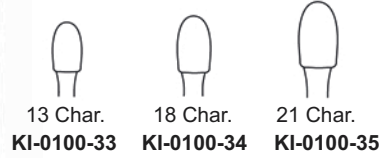

**MOORE**  
 30,0 cm, 12"  
 KI-0100-36

Gallenblasenlöffel  
 Gall bladder scoope  
 Cuccharilla para la vesicula biliar  
 Cucchiaio per colecisti



**DESJARDINS**  
 28,0 cm, 11"





# General Surgery Instruments



"Supporting Healthcare"  
**KAAHA INDUSTRIES**  
Manufacturer Of Dental & Surgical Instruments

Gallengang Dilatatoren  
Common Bile Duct Dilators  
Dilatadores para el conducto biliar  
Dilatatori per coledoco

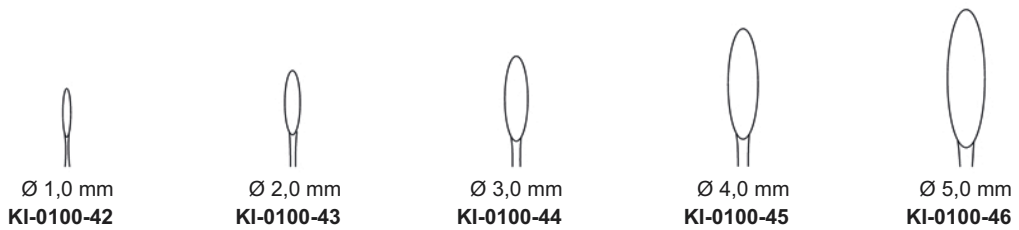

**BAKES**  
30,0 cm, 11<sup>3</sup>/<sub>4</sub>"  
KI-0100-41

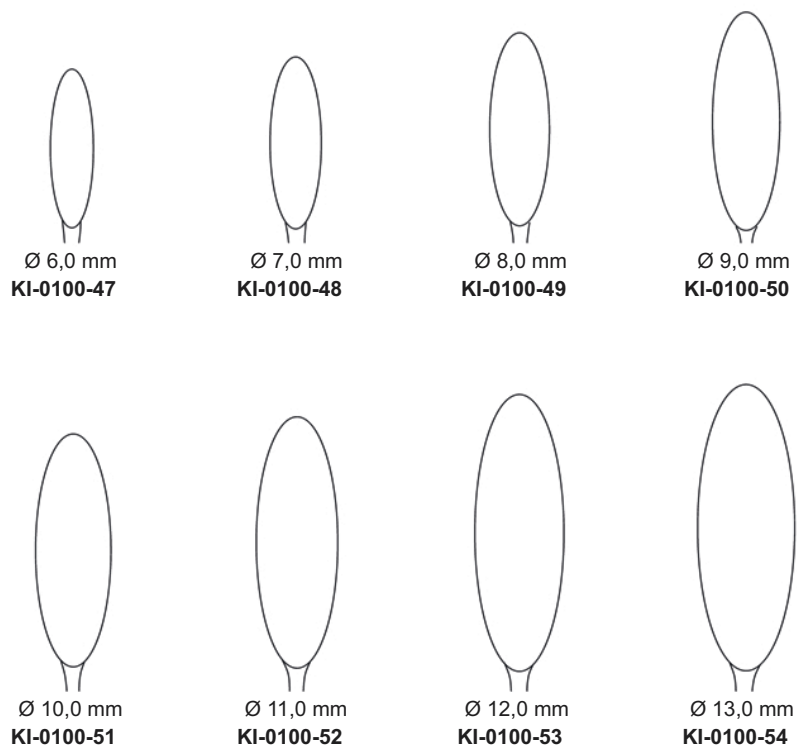



# General Surgery Instruments



"Supporting Healthcare"  
**KAAHA INDUSTRIES**  
 Manufacturer Of Dental & Surgical Instruments

Instrumente für Prostektomie  
 Prostatectomy Instruments  
 Instrumentos para la prostatectomía  
 Strumenti per operazioni della prostata



**MILLIN**  
 23,0 cm, 9"  
 KI-0100-63



**ATRAUMA**  
**MILLIN**  
 24,0 cm, 9½"  
 KI-0100-64



**MILLIN**  
 24,0 cm, 9½"  
 KI-0100-65



**MILLIN**  
 23,0 cm, 9"  
 KI-0100-66



**MILLIN**  
 28,5 cm, 11¼"  
 KI-0100-67

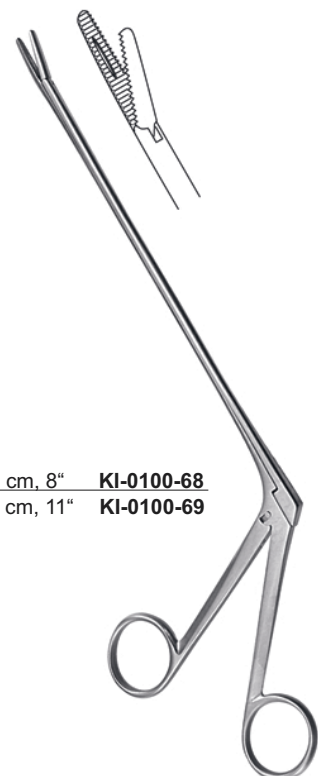

20,0 cm, 8" **KI-0100-68**  
 28,0 cm, 11" **KI-0100-69**

**MATHIEU**

Prostatahaken, Blasenspatel  
Prostatic Retractors, Bladder Retractor  
Separadores para la prostata, Separadores vesicales  
Retrattori prostatici, Divaricatori vescicali



**YOUNG**  
21,0 cm, 8<sup>1</sup>/<sub>4</sub>"  
KI-0100-70



**YOUNG**  
22,0 cm, 8<sup>5</sup>/<sub>8</sub>"  
KI-0100-71



**YOUNG**  
21,0 cm, 8<sup>1</sup>/<sub>4</sub>"  
KI-0100-72

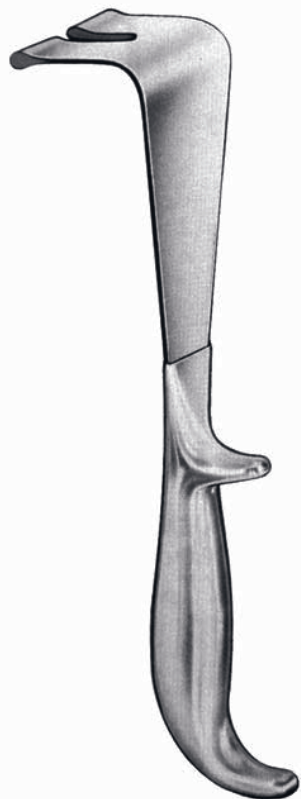

**YOUNG**  
22,0 cm, 8<sup>5</sup>/<sub>8</sub>"  
KI-0100-73



**LEGUEU**  
26,0 cm, 10<sup>1</sup>/<sub>4</sub>"  
KI-0100-74



**KOCHER**  
23,5 cm, 9<sup>1</sup>/<sub>4</sub>"  
KI-0100-75

# General Surgery Instruments



"Supporting Healthcare"  
**KAHA INDUSTRIES**  
 Manufacturer Of Dental & Surgical Instruments

Katheter, Penisklemmen  
 Catheters, Penis Clamp  
 Sondas, Compresor urétral  
 Cateteri, Serrapene



für Männer  
 for men  
 para hombres  
 per uomini

Char. 8	KI-0100-76
Char. 10	KI-0100-77
Char. 12	KI-0100-78
Char. 14	KI-0100-79
Char. 16	KI-0100-80
Char. 18	KI-0100-81
Char. 20	KI-0100-82
Char. 22	KI-0100-83
Char. 24	KI-0100-84

29,0 cm, 11 1/2"



für Frauen  
 for women  
 para mujeres  
 per donne

Char. 6	KI-0100-85
Char. 7	KI-0100-86
Char. 8	KI-0100-87
Char. 9	KI-0100-88
Char. 10	KI-0100-89
Char. 11	KI-0100-90
Char. 12	KI-0100-91
Char. 13	KI-0100-92
Char. 14	KI-0100-93
Char. 15	KI-0100-94
Char. 16	KI-0100-95
Char. 18	KI-0100-96
Char. 20	KI-0100-97
Char. 24	KI-0100-98

16,0 cm, 6 1/4"



**STRAUSS**  
 11,0 cm, 4 1/3"  
 KI-0100-99



**STOCKMANN**  
 8,0 cm, 3 1/4"  
 KI-0200-01

Ø 8,0 mm	KI-0200-02
Ø 11,0 mm	KI-0200-03
Ø 13,0 mm	KI-0200-04
Ø 16,0 mm	KI-0200-05
Ø 21,0 mm	KI-0200-06
Ø 26,0 mm	KI-0200-07
Ø 32,0 mm	KI-0200-08

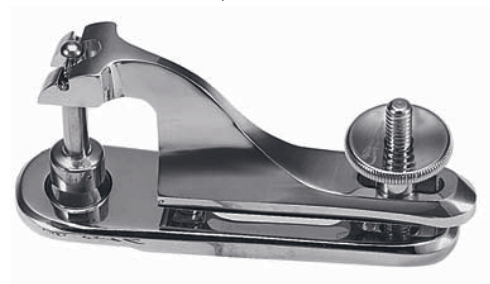

**COMCO**



“Supporting Healthcare”

**KAAHA INDUSTRIES**

Manufacturer Of Dental & Surgical Instruments

**C11**

**230 to 245**



**Magen, Darm, MaAKdarm**

**AKomach, InteAKines, ReAKum**

**EAKómoago, InteAKino, ReAKo**

**AKomaco, InteAKino, Retto**

Darm- und Gewebefazangen  
 Intestinal and Tissue Grasping Forceps  
 Pinzas intestinales y para tejidos  
 Pinze da presa per intestino e tessuti

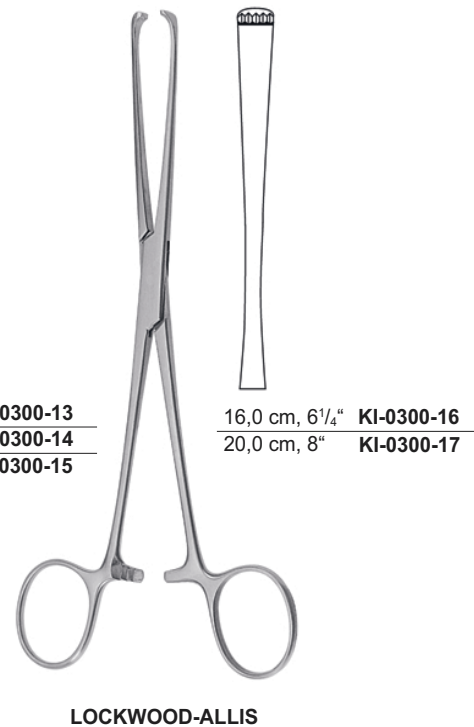
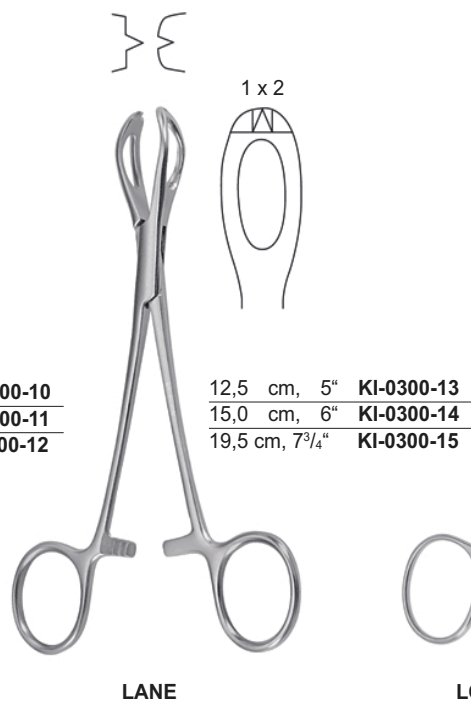
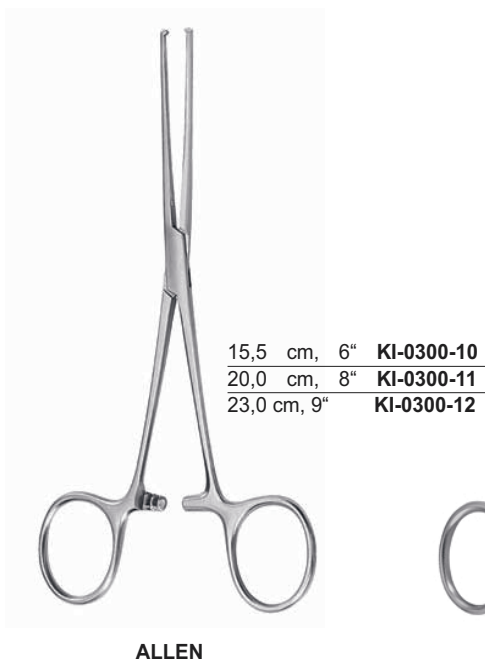
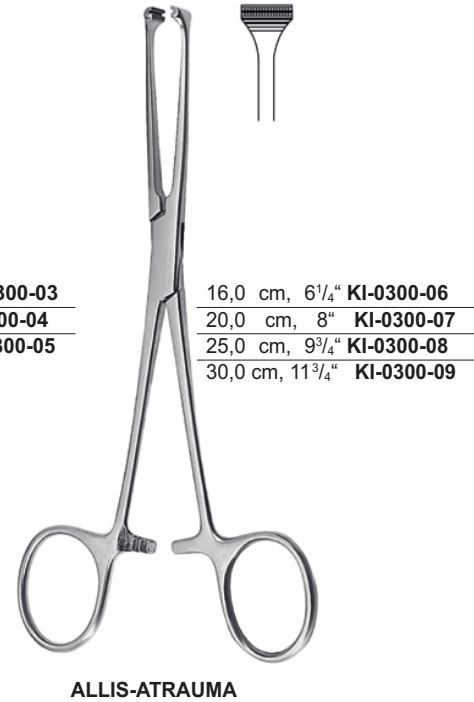
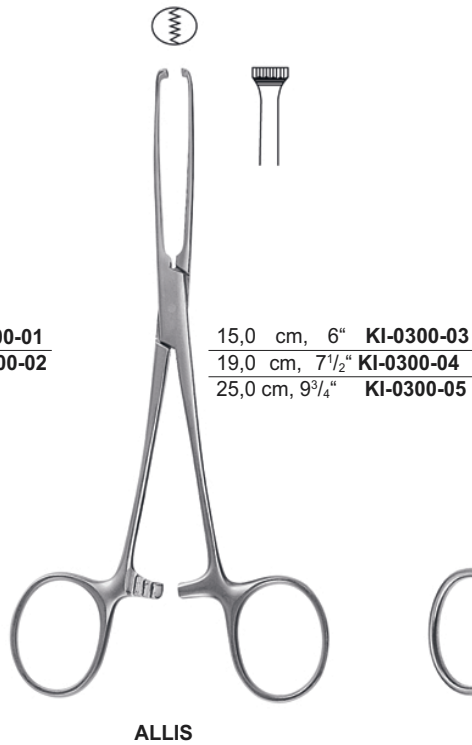
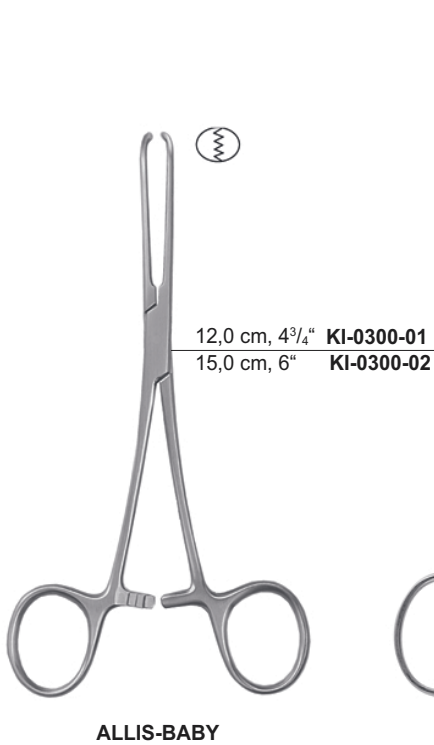

Darm- und Gewebefäßzangen  
 Intestinal and Tissue Grasping Forceps  
 Pinzas intestinales y para tejidos  
 Pinze da presa per intestino e tessuti



15,0 cm, 6" **KI-0300-18**  
 19,0 cm, 7½" **KI-0300-19**

**JUDD-ALLIS**



**LITTLEWOOD**  
 18,5 cm, 7¼"  
**KI-0300-20**



**ALLIS-ADAIR**  
 15,5 cm, 6"  
**KI-0300-21**



**BOYS-ALLIS**  
 15,5 cm, 6"  
**KI-0300-22**



**THOMS-ALLIS**  
 20,0 cm, 8"  
**KI-0300-23**



**ALLIS**  
 20,0 cm, 8"  
**KI-0300-24**



Darm- und Gewebefaszangen  
 Intestinal and Tissue Grasping Forceps  
 Pinzas intestinales y para tejidos  
 Pinze da presa per intestino e tessuti



**LOCKWOOD**  
 20,0 cm, 8"  
 KI-0300-25

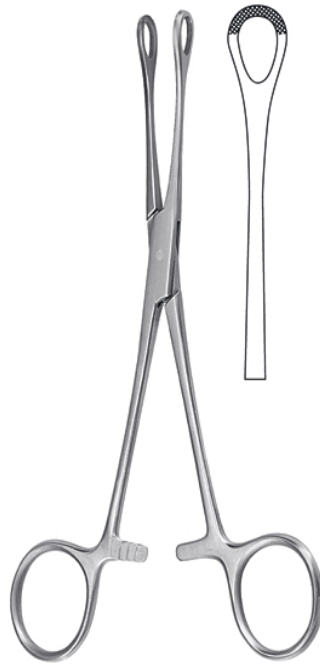

**WILLIAMS**  
 16,0 cm, 6 1/4"  
 KI-0300-26

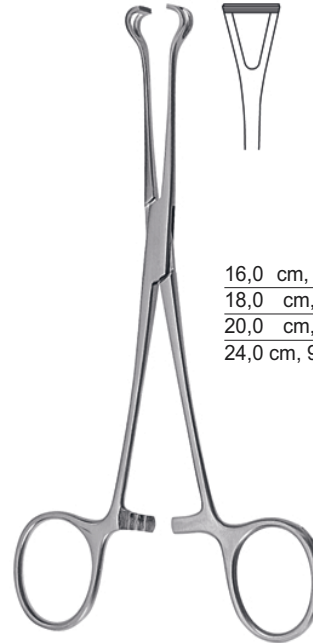

16,0 cm, 6 1/4" **KI-0300-27**  
 18,0 cm, 7" **KI-0300-28**  
 20,0 cm, 8" **KI-0300-29**  
 24,0 cm, 9 1/2" **KI-0300-30**



**BABCOCK-ATRAUMA**

16,0 cm, 6 1/4" **KI-0300-31**  
 20,0 cm, 8" **KI-0300-32**



**BABCOCK-TC**

16,0 cm, 6 1/4" **KI-0300-33**  
 20,0 cm, 8" **KI-0300-34**



**DUVAL-TC**  
 20,0 cm, 8"  
 KI-0300-35

Darmklemmen  
 Intestinal Clamp Forceps  
 Pinzas-clamps intestinales  
 Pinze intestinali



**DUVAL**

18,0 cm, 7"	<b>KI-0300-36</b>
20,0 cm, 8"	<b>KI-0300-37</b> <b>KI-0300-38</b>
23,0 cm, 9"	<b>KI-0300-39</b>

Darm- und Gewebefaßzangen  
 Intestinal and Tissue Grasping Forceps  
 Pinzas intestinales y para tejidos  
 Pinze da presa per intestino e tessuti



**BABY-DOYEN**  
 18,0 cm, 7"

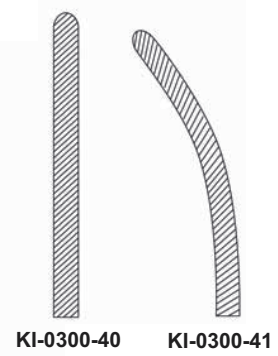

**DOYEN**

21,0 cm, 8 1/4"	<b>KI-0300-42</b>	21,0 cm, 8 1/4"	<b>KI-0300-44</b>
23,0 cm, 9"	<b>KI-0300-43</b>	23,0 cm, 9"	<b>KI-0300-45</b>

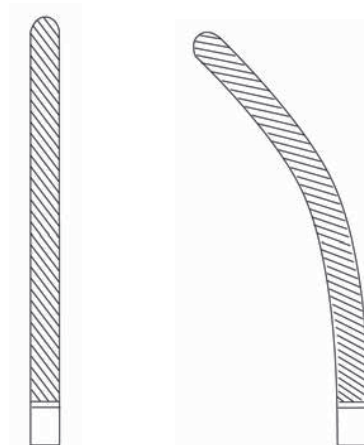

Darmklemmen  
 Intestinal Clamp Forceps  
 Pinzas-clamps intestinales  
 Pinze intestinali



**DOYEN**

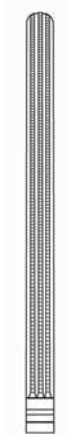

21,0 cm, 8<sup>1</sup>/<sub>4</sub>" **KI-0300-46**  
 23,0 cm, 9" **KI-0300-47**

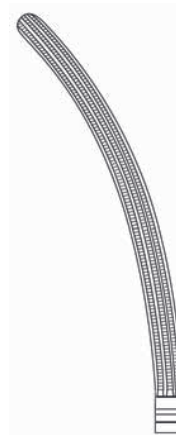

21,0 cm, 8<sup>1</sup>/<sub>4</sub>" **KI-0300-48**  
 23,0 cm, 9" **KI-0300-49**

mit atraumatischer Zahnung  
 with atraumatic serration  
 con bacos atraumáticas  
 con morsi atraumatici



**KOCHER**

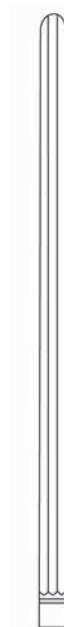

22,0 cm, 8<sup>5</sup>/<sub>8</sub>" **KI-0300-50**  
 25,0 cm, 9<sup>3</sup>/<sub>4</sub>" **KI-0300-51**  
 28,0 cm, 11" **KI-0300-52**



22,0 cm, 8<sup>5</sup>/<sub>8</sub>" **KI-0300-53**  
 25,0 cm, 9<sup>3</sup>/<sub>4</sub>" **KI-0300-54**  
 28,0 cm, 11" **KI-0300-55**

Darmklemmen  
 Intestinal Clamp Forceps  
 Pinzas-clamps intestinales  
 Pinze intestinali



**KOCHER**

mit atraumatischer Zahnung  
 with atraumatic serration  
 con bacos atraumáticos  
 con morsi atraumatici

22,0 cm, 8<sup>5</sup>/<sub>8</sub>" **KI-0300-56**  
 25,0 cm, 9<sup>3</sup>/<sub>4</sub>" **KI-0300-57**  
 28,0 cm, 11" **KI-0300-58**



22,0 cm, 8"  
 25,0 cm, 9<sup>3</sup>/<sub>4</sub>"



" **KI-0300-59**  
 " **KI-0300-60**  
 28,0 cm, 11" **KI-0300-61**



**MAYO-ROBSON**

21,0 cm, 8<sup>1</sup>/<sub>4</sub>" **KI-0300-62**  
 23,0 cm, 9" **KI-0300-63**  
 25,0 cm, 9<sup>3</sup>/<sub>4</sub>" **KI-0300-64**



21,0 cm, 8<sup>1</sup>/<sub>4</sub>" **KI-0300-65**  
 23,0 cm, 9" **KI-0300-66**  
 25,0 cm, 9<sup>3</sup>/<sub>4</sub>" **KI-0300-67**

Darmklemmen  
 Intestinal Clamp Forceps  
 Pinzas-clamps intestinales  
 Pinze intestinali



**MAYO-ROBSON**

21,0 cm, 8 1/4"	<b>KI-0300-68</b>	21,0 cm, 8 1/4"	<b>KI-0300-71</b>
23,0 cm, 9"	<b>KI-0300-69</b>	23,0 cm, 9"	<b>KI-0300-72</b>
25,0 cm, 9 3/4"	<b>KI-0300-70</b>	25,0 cm, 9 3/4"	<b>KI-0300-73</b>

mit atraumatischer Zahnung  
 with atraumatic serration  
 con bacos atraumáticos  
 con morsi atraumatici

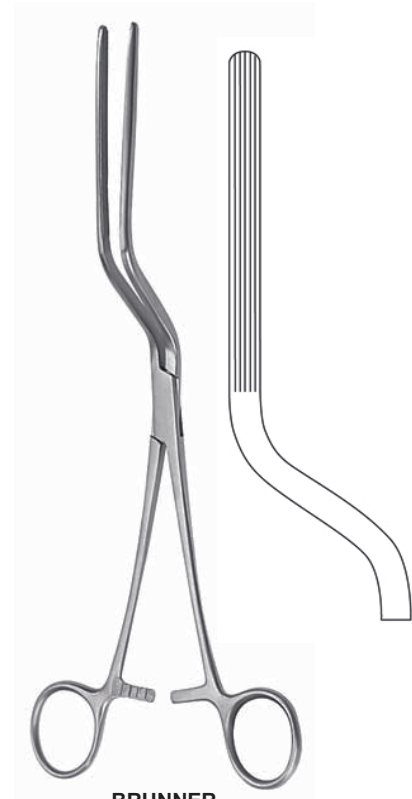

**BRUNNER**  
 24,0 cm, 9 1/2"  
**KI-0300-74**

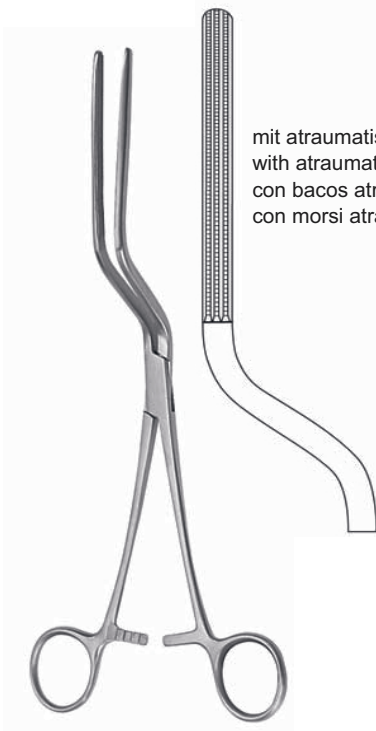

mit atraumatischer Zahnung  
 with atraumatic serration  
 con bacos atraumáticos  
 con morsi atraumatici

24,0 cm, 9 1/2"  
**KI-0300-75**

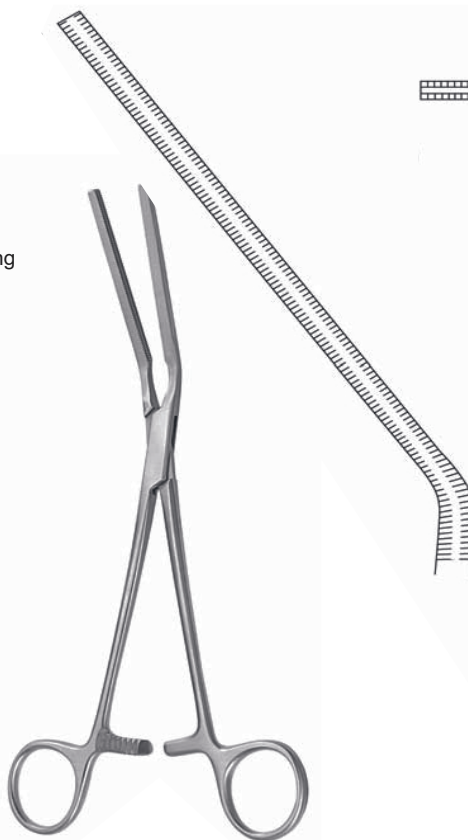

**GLASSMAN**  
 23,0 cm, 9"  
**KI-0300-76**



**GLASSMAN**  
 23,5 cm, 9 1/4"  
**KI-0300-77**

Darm- und Magenquetschklemmen  
 Intestinal and Stomach Clamps  
 Pinzas-clamps intestinales y estomacales  
 Pinze/Clamp per intestino e stomaco

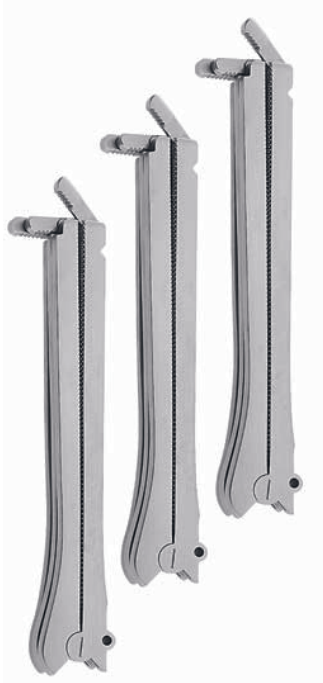

Maullänge  
 length of jaws  
 longitud de la boca  
 bocche lungh.

5,0 cm, 2" **KI-0300-78**  
 7,0 cm, 2 1/2" **KI-0300-79**  
 10,0 cm, 4" **KI-0300-80**

**DE MARTEL-WOLFSON**



**DE MARTEL-WOLFSON**  
 8,5 cm, 3 1/2"  
**KI-0300-81**



**DE MARTEL-WOLFSON**  
 26,0 cm, 10 1/4"  
**KI-0300-82**



**BABY-PAYR**  
 15,0 cm, 6"



**KI-0300-83**  
 mit Stift  
 with pin  
 con espiga  
 con perno



**KI-0300-84**  
 ohne Stift  
 without pin  
 sin espiga  
 senza perno



**PAYR**



21,0 cm, 8 1/4"  
**KI-0300-85**



29,0 cm, 11 1/2"  
**KI-0300-86** **KI-0300-87**  
**KI-0300-88**

mit Stift  
 with pin  
 con espiga  
 con perno

ohne Stift  
 without pin  
 sin espiga  
 senza perno

Darm- und Magenklappen  
 Intestinal and Stomach Clamp Forceps  
 Pinzas-clamps intestinales y estomacales  
 Pinze per intestino e stomaco



KI-0300-89

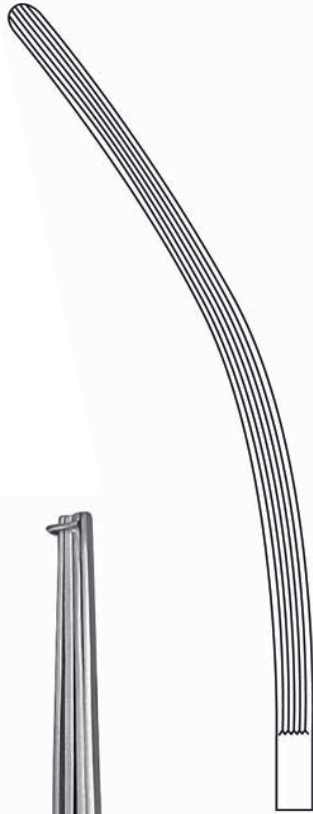

KI-0300-90



KI-0300-91



KI-0300-92

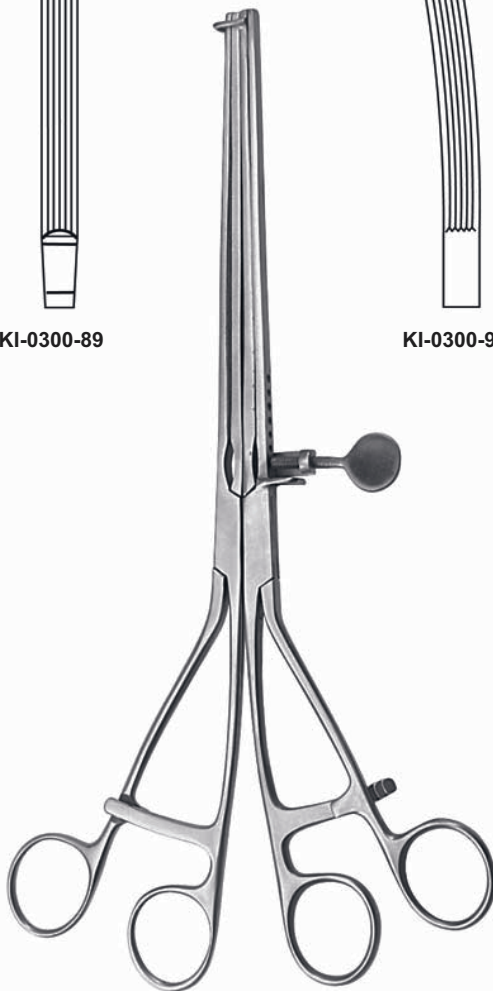

**LANE**  
 30,0 cm, 11<sup>3</sup>/<sub>4</sub>”

mit atraumatischer Zahnung  
 with atraumatic serration  
 con bacos atraumáticas  
 con morsi atraumatici



**SCUDDER**  
 33,0 cm, 13”

Rektum-Anastomosenklemmen  
Sigmoid Anastomosis Forceps  
Pinzas para anastomosis de recto  
Pinze per anastomosi de retto



19,0 cm, 7 1/2"  
KI-0300-93

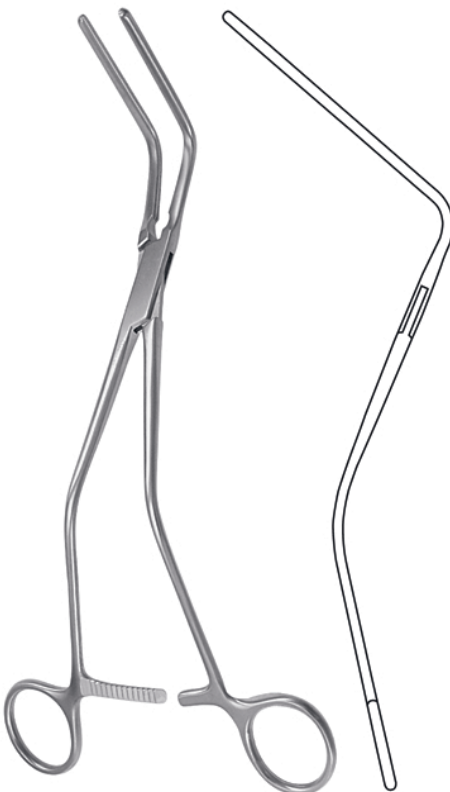
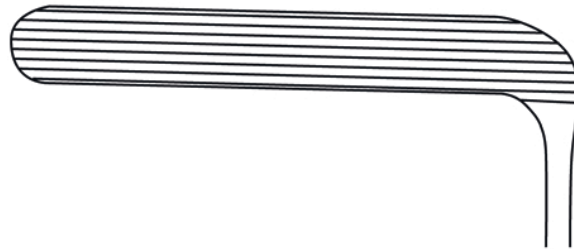

HAYES

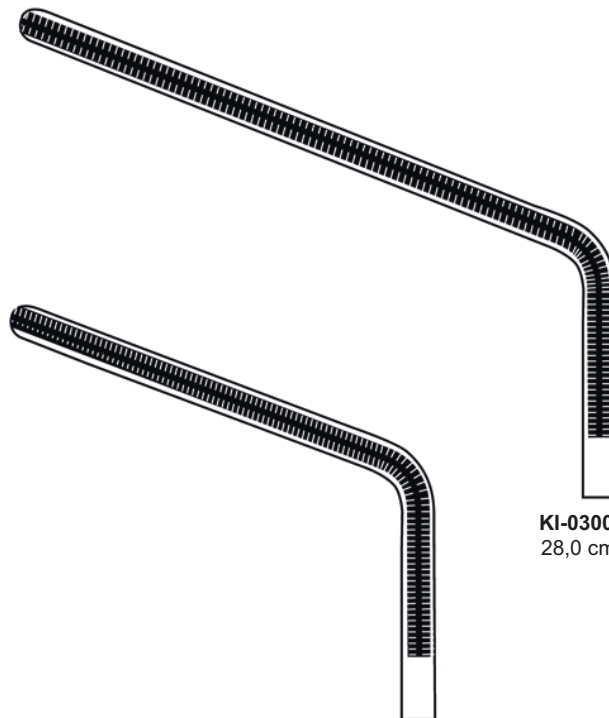

KI-0300-94  
28,0 cm, 11"

KI-0300-95  
26,0 cm, 10"



Mastdarm-Rektum-Spekula  
Rectal Specula  
Espéculos para el recto  
Speculi rectali

17 x 89 mm



**SIMS**  
15,0 cm, 6"  
KI-0300-96

17 x 89 mm



**SIMS**  
15,0 cm, 6"  
KI-0300-97

25 x 89 mm



**MATHIEU**  
21,0 cm, 8<sup>1</sup>/<sub>4</sub>"  
KI-0300-98

75 x 23 mm



**SMITH-BUIE**  
15,0 cm, 6"  
KI-0300-99

Analnspreizer, Sphinkterskope, Anuskope  
 Rectal Retractor, Sphincteroscopes, Anoscope  
 Separadores para el recto, Esfinteroscopios, Anoscopios  
 Dilatatori per l'ano ed il retti, Sfinteroscopi, Anoscopi

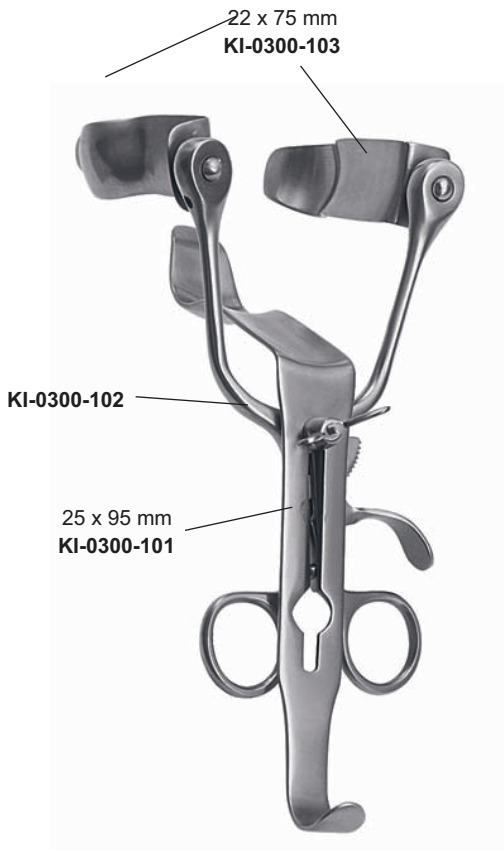

**ALAN PARKS**  
 13,5 cm, 5<sup>3</sup>/<sub>8</sub>"  
**KI-0300-100**



Kaltlichtkammer für Proktoskope  
 Cold-light clip for proctoscopes  
 Clip para luz fría con proctoscopios  
 Clip per luce fredda con protoscopi

**KI-0300-105**



- Ø 22 x 50 mm **KI-0300-106**
- Ø 22 x 100 mm **KI-0300-107**
- Ø 22 x 145 mm **KI-0300-108**
- Ø 22 x 200 mm **KI-0300-109**
- Ø 21 x 50 mm **KI-0300-110**
- Ø 27 x 50 mm **KI-0300-111**

**HAYES**



- Ø 16 x 65 mm **KI-0300-112**
- Ø 19 x 65 mm **KI-0300-113**
- Ø 22 x 65 mm **KI-0300-114**
- Ø 22 x 130 mm **KI-0300-115**

**HIRSCHMANN**

Anuskope, Proktoskope  
 Anoscope, Proctoscopes  
 Anoscopios, Proctoscopios  
 Anoscopi, Protoscopi



Ø 22 x 65 mm **KI-0300-116**  
 Ø 30 x 65 mm **KI-0300-117**

**CHELSEA EATON**



ohne Kaltlichtträger  
 without cold light carrier  
 sin portador para luz fría  
 senza luce fredda

mit Kaltlichtträger  
 with cold light carrier  
 con portador para luz fría  
 con luce fredda

**IVES FANSLER**  
 Ø 22 mm  
**KI-0300-118**

**IVES FANSLER**  
 Ø 22 mm  
**KI-0300-119**



Ø 17 x 65 mm **KI-0300-120**  
 Ø 17 x 80 mm **KI-0300-121**  
 Ø 20 x 65 mm **KI-0300-122**  
 Ø 20 x 80 mm **KI-0300-123**  
 Ø 24 x 65 mm **KI-0300-124**  
 Ø 24 x 80 mm **KI-0300-125**

**MORGAN**



**KI-0300-126**

**FANSLER**

Ø 25 x 65 mm **KI-0300-127**  
 Ø 29 x 65 mm **KI-0300-128**  
 Ø 38 x 70 mm **KI-0300-129**

**Mastdarm-Biopsiezangen**  
**Rectal Biopsy Forceps**  
 Pinzas sacabocado para biopsia rectal  
 Pinze taglienti per biopsia rettale

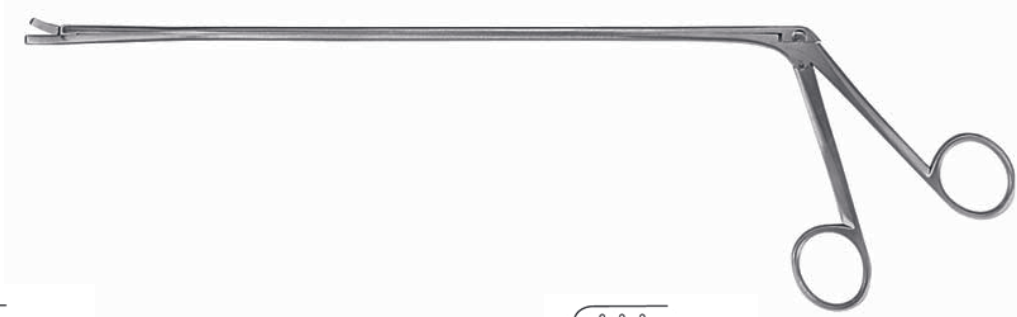

28,0 cm, 11" **KI-0300-130**  
 35,0 cm, 13<sup>3</sup>/<sub>4</sub>" **KI-0300-131**  
 42,0 cm, 16<sup>1</sup>/<sub>2</sub>" **KI-0300-132**



28,0 cm, 11" **KI-0300-133**  
 35,0 cm, 13<sup>3</sup>/<sub>4</sub>" **KI-0300-134**  
 42,0 cm, 16<sup>1</sup>/<sub>2</sub>" **KI-0300-135**



28,0 cm, 11" **KI-0300-136**  
 35,0 cm, 13<sup>3</sup>/<sub>4</sub>" **KI-0300-137**  
 42,0 cm, 16<sup>1</sup>/<sub>2</sub>" **KI-0300-138**

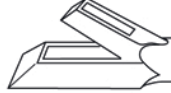

28,0 cm, 11" **KI-0300-139**  
 35,0 cm, 13<sup>3</sup>/<sub>4</sub>" **KI-0300-140**  
 42,0 cm, 16<sup>1</sup>/<sub>2</sub>" **KI-0300-141**

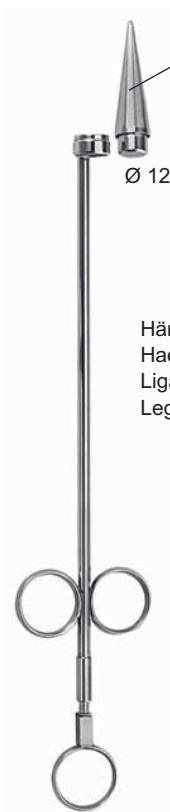

**KI-0300-142**

Ø 12,0 mm

Hämorrhoiden-Ligator mit Ladekonus  
 Haemorroidal ligator with loading attachment  
 Ligador para hemorroides con cono de carga  
 Legatori emorroidali con carica a cono

**RUDD**  
**KI-0300-144**

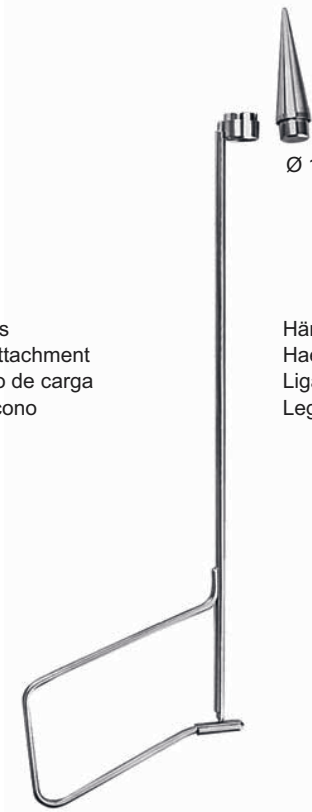

**KI-0300-143**

Ø 12,0 mm

Hämorrhoiden-Ligator mit Ladekonus  
 Haemorroidal ligator with loading attachment  
 Ligador para hemorroides con cono de carga  
 Legatori emorroidali con carica a cono

**MC GIVNEY**  
**KI-0300-145**

Hämorrhoiden-Faßzangen, Fistelsonden  
Haemorrhoidal Forceps, Fistula probes  
Pinza-clamps para hemorroides, Sondas para fistula  
Pinze per emorroidi. Sonde per fistola



**MC GIVNEY**  
19,0 cm, 7½"  
KI-0300-146



**MC GIVNEY**  
19,0 cm, 7½"  
KI-0300-147



**PRATT**  
21,0 cm, 8¼"



KI-0300-148



KI-0300-149



KI-0300-150



"Supporting Healthcare"

**KAAHA INDUSTRIES**

Manufacturer Of Dental & Surgical Instruments

**C12**

**246 to 281**



**Gynäkologie, GebuAAKhilfe**

**Gynecology, ObAKetrics**

**Ginecología, ObAKetricia**

**Ginecologia, OAKetricia**

Scheidenspekula  
 Vaginal Specula  
 Espéculos vaginales  
 Speculi vaginali

für Kinder  
 for children  
 para niños  
 per bambini



**COLLIN**  
 65 x 10 mm  
**KI-0400-01**

für Jungfrauen  
 for virgins  
 para vírgenes  
 per vergini



**COLLIN**  
 65 x 10 mm  
**KI-0400-02**

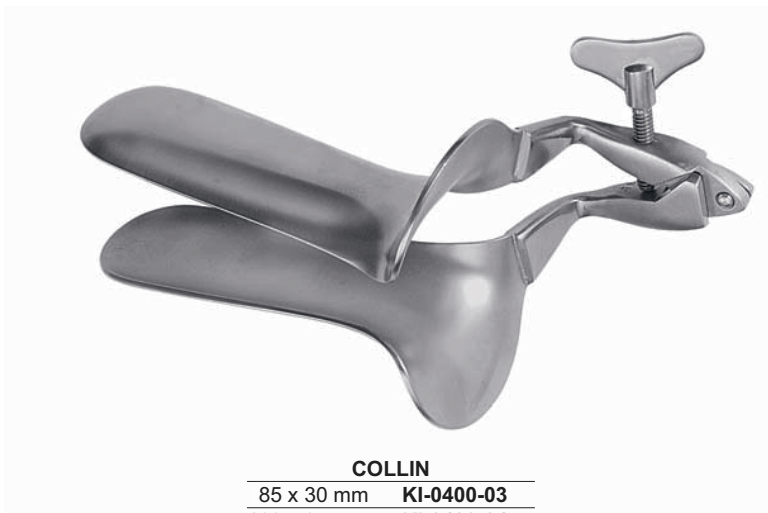

**COLLIN**

85 x 30 mm	<b>KI-0400-03</b>
100 x 35 mm	<b>KI-0400-04</b>
110 x 40 mm	<b>KI-0400-05</b>



**CUSCO**

80 x 24 mm	<b>KI-0400-06</b>
80 x 32 mm	<b>KI-0400-07</b>
98 x 16 mm	<b>KI-0400-08</b>
105 x 25 mm	<b>KI-0400-09</b>
107 x 29 mm	<b>KI-0400-10</b>
115 x 35 mm	<b>KI-0400-11</b>

Scheidenspekula  
 Vaginal Specula  
 Espécules vaginales  
 Speculi vaginali



zentrale Stellschraube  
 central fixation screw  
 tornillo de sujeto central  
 vite di regolazione centrale

**CUSCO**

75 x 32 mm	<b>KI-0400-12</b>
85 x 36 mm	<b>KI-0400-13</b>
95 x 37 mm	<b>KI-0400-14</b>



seitliche Stellschraube  
 lateral fixation screw  
 tornillo de sujeto lateral  
 vite di regolazione laterale

für Jungfrauen  
 for virgins  
 para virgenes  
 per vergini

**CUSCO**

75 x 17 mm	<b>KI-0400-15</b>
------------	-------------------



seitliche Stellschraube  
 lateral fixation screw  
 tornillo de sujeto lateral  
 vite di regolazione laterale

**CUSCO**

75 x 32 mm	<b>KI-0400-16</b>
85 x 35 mm	<b>KI-0400-17</b>
100 x 35 mm	<b>KI-0400-18</b>



Schweizer Modell  
 Swiss pattern  
 Modelo suizo  
 Modello svizzero

**CUSCO**

90 x 23-25 mm	<b>KI-0400-19</b>
100 x 25-27 mm	<b>KI-0400-20</b>
110 x 27-30 mm	<b>KI-0400-21</b>



Scheidenspekula  
 Vaginal Specula  
 Espéculos vaginales  
 Speculi vaginali



**GRAVE**  
 75 x 20 mm **KI-0400-22**  
 95 x 35 mm **KI-0400-23**  
 115 x 35 mm **KI-0400-24**



**PEDERSON**  
 75 x 13 mm **KI-0400-25**  
 100 x 22 mm **KI-0400-26**  
 120 x 25 mm **KI-0400-27**



**SEMM**  
 90 x 14-18 mm **KI-0400-28**  
 100 x 17-20 mm **KI-0400-29**  
 100 x 25-30 mm **KI-0400-30**



**WEISSBARTH**  
 21,0 cm, 8 1/4"  
**KI-0400-31**

Scheidenspekula  
 Vaginal Specula  
 Espéculos vaginales  
 Speculi vaginali



1,14 kg

**AUVARD**  
 75 x 38 mm  
 KI-0400-32



1,14 kg

**AUVARD**  
 75 x 38 mm  
 KI-0400-33

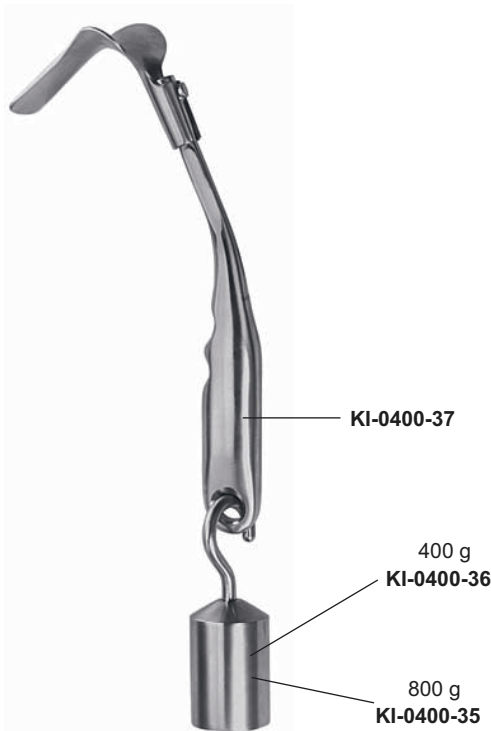

**SCHERBACK**  
 KI-0400-34

koplett, complete, completo, completo

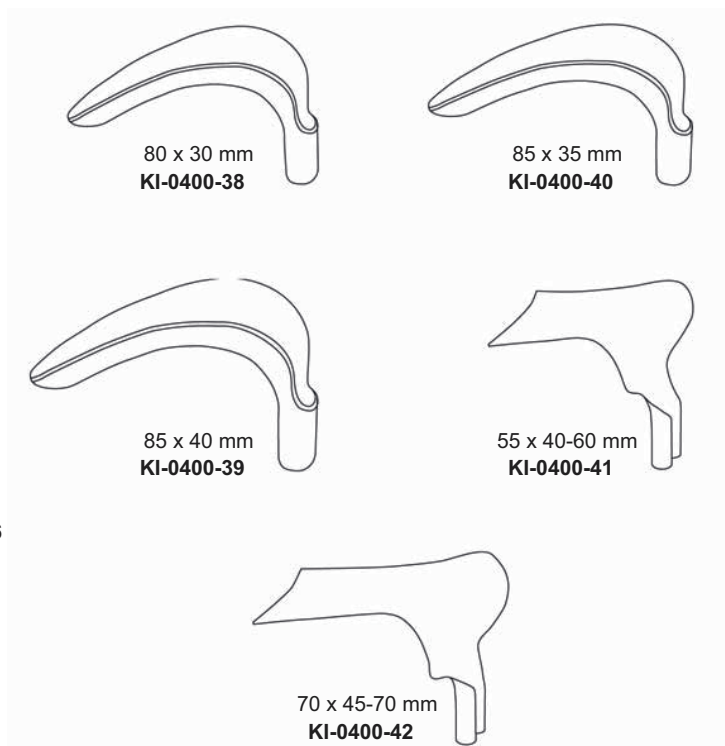

Scheidenspekula  
 Vaginal Specula  
 Espéculos vaginales  
 Speculi vaginali



Satz  
 Set  
 Juego  
 Set

**KRISTELLER**  
 Fig. 1 **KI-0400-43**  
 Fig. 2 **KI-0400-44**  
 Fig. 3 **KI-0400-45**



Spekula allein, fl ach  
 Specula only, fl at hollow  
 Espéculos suelto, con huecos planos  
 Solo speculi, piatta

**KRISTELLER**  
 105 x 26 mm **KI-0400-46**  
 105 x 28 mm **KI-0400-47**  
 105 x 33 mm **KI-0400-48**

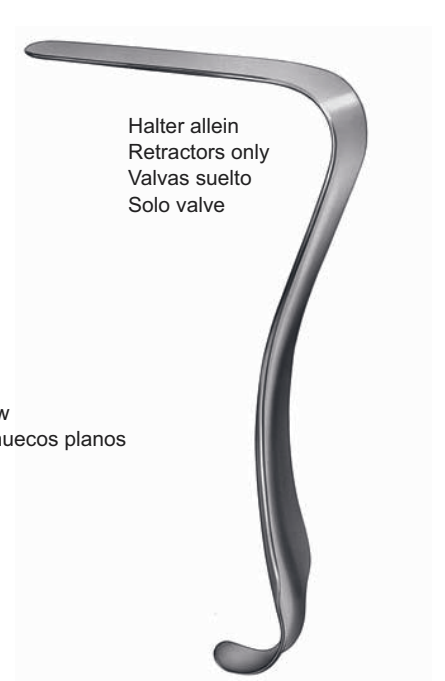

Halter allein  
 Retractors only  
 Valvas suelto  
 Solo valve

**KRISTELLER**  
 115 x 22 mm **KI-0400-49**  
 115 x 24 mm **KI-0400-50**  
 115 x 29 mm **KI-0400-51**



Satz  
 Set  
 Juego  
 Set

**KRISTELLER**  
 Fig. 1 **KI-0400-52**  
 Fig. 2 **KI-0400-53**  
 Fig. 3 **KI-0400-54**



Spekula allein, fl ach  
 Specula only, fl at hollow  
 Espéculos suelto, con huecos planos  
 Solo speculi, piatta

**KRISTELLER**  
 110 x 27 mm **KI-0400-55**  
 110 x 30 mm **KI-0400-56**  
 110 x 36 mm **KI-0400-57**

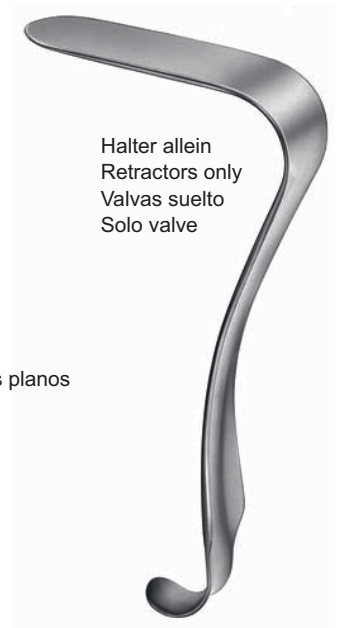

Halter allein  
 Retractors only  
 Valvas suelto  
 Solo valve

**KRISTELLER**  
 115 x 23 mm **KI-0400-58**  
 115 x 26 mm **KI-0400-59**  
 115 x 32 mm **KI-0400-60**

Scheidenspekula  
 Vaginal Specula  
 Espéculos vaginales  
 Speculi vaginali



Satz  
 Set  
 Juego  
 Set

**KRISTELLER**

Fig. 0 **KI-0400-61**  
 Fig. 1 **KI-0400-62**  
 Fig. 2 **KI-0400-63**  
 Fig. 3 **KI-0400-64**



Spekula allein  
 Specula only  
 Espéculos suelto  
 Solo speculi

**KRISTELLER**

70 x 15 mm **KI-0400-65**  
 70 x 27 mm **KI-0400-66**  
 80 x 30 mm **KI-0400-67**  
 90 x 36 mm **KI-0400-68**

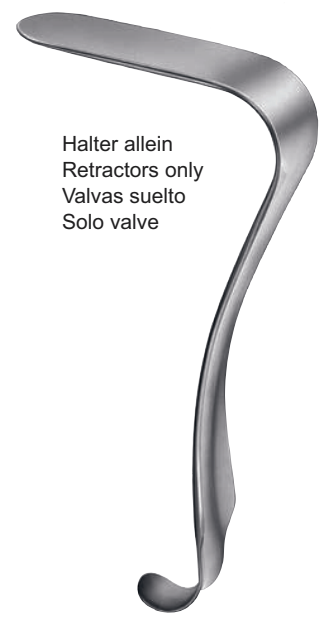

Halter allein  
 Retractors only  
 Valvas suelto  
 Solo valve

**KRISTELLER**

75 x 10 mm **KI-0400-69**  
 75 x 23 mm **KI-0400-70**  
 85 x 26 mm **KI-0400-71**  
 100 x 32 mm **KI-0400-72**



konisch, für Jungfrauen  
 conical blades, for virgins  
 valvos cónicos, para virgenes  
 valve coniche, per vergini

Satz  
 Set  
 Juego  
 Set

**KRISTELLER**

Fig. 00 **KI-0400-73**  
 Fig. 0 **KI-0400-74**



Spekula allein  
 Specula only  
 Espéculos suelto  
 Solo speculi

**KRISTELLER**

105 x 18 mm **KI-0400-75**  
 105 x 21 mm **KI-0400-76**



Halter allein  
 Retractors only  
 Valvas suelto  
 Solo valve

**KRISTELLER**

110 x 14 mm **KI-0400-77**  
 110 x 17 mm **KI-0400-78**

Scheidenspekula  
 Vaginal Specula  
 Espéculos vaginales  
 Speculi vaginali



leicht hohl  
 slightly-concave  
 ligeremente concavos  
 leggeremente concavi

Fig	a x b	
1	55 x 35 mm	KI-0400-79
2	85 x 35 mm	KI-0400-80
3	115 x 35 mm	KI-0400-81
1	55 x 45 mm	KI-0400-82
2	85 x 45 mm	KI-0400-83
3	115 x 45 mm	KI-0400-84
4	160 x 45 mm	KI-0400-85
1	55 x 60 mm	KI-0400-86
2	85 x 60 mm	KI-0400-87
3	115 x 60 mm	KI-0400-88
4	160 x 60 mm	KI-0400-89

**DOYEN**  
 23,0 cm, 9"

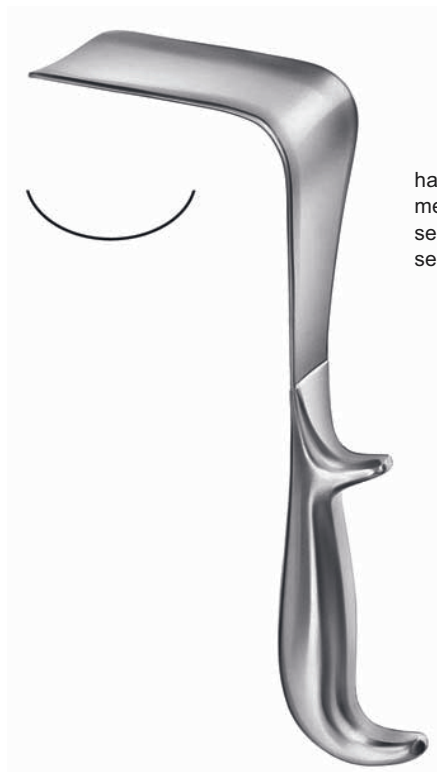

halb-hohl  
 medium-concave  
 semi-concavos  
 semi-concavi

Fig	a x b	
1	55 x 35 mm	KI-0400-90
2	85 x 35 mm	KI-0400-91
3	115 x 35 mm	KI-0400-92
1	55 x 45 mm	KI-0400-93
2	85 x 45 mm	KI-0400-94
3	115 x 45 mm	KI-0400-95
1	55 x 60 mm	KI-0400-96
2	85 x 60 mm	KI-0400-97
3	115 x 60 mm	KI-0400-98

**DOYEN**  
 23,0 cm, 9"

Scheidenspekula  
 Vaginal Specula  
 Espéculos vaginales  
 Speculi vaginali



Satz  
 Set  
 Juego  
 Set

**KALLMORGEN**  
 70 x 40 mm **KI-0400-99**  
 90 x 40 mm **KI-0400-100**



Spekula allein  
 Specula only  
 Espéculos suelto  
 Solo speculi

**KALLMORGEN**  
 70 x 40 mm **KI-0400-101**  
 90 x 40 mm **KI-0400-102**



Halter allein  
 Retractors only  
 Valvas suelto  
 Solo valve

**KALLMORGEN**  
 70 x 40 mm **KI-0400-103**  
 90 x 40 mm **KI-0400-104**



70 x 15 mm

**KRISTELLER**  
 17,0 cm, 6<sup>3</sup>/<sub>4</sub>“  
**KI-0400-105**



75 x 39 mm

**KALLMORGEN**  
 17,0 cm, 6<sup>3</sup>/<sub>4</sub>“  
**KI-0400-106**



**JACKSON**  
 75 x 38 mm **KI-0400-107**  
 90 x 38 mm **KI-0400-108**  
 100 x 38 mm **KI-0400-109**

Scheidenspekula  
Vaginal Specula  
Espéculos vaginales  
Speculi vaginali

76 x 25 mm



70 x 22 mm

**BREISKY**  
14,0 cm, 5½"  
KI-0400-110

82 x 30 mm



76 x 25 mm

**BREISKY**  
14,0 cm, 5½"  
KI-0400-111

95 x 38 mm



82 x 30 mm

**BREISKY**  
17,0 cm, 6¾"  
KI-0400-112

102 x 44 mm



95 x 38 mm

**BREISKY**  
17,0 cm, 6¾"  
KI-0400-113

**Scheidenspekula und -halter**  
**Vaginal Specula and Retractors**  
**Espéculos y valvas vaginales**  
**Speculi e valve vaginali**

**SIMS**  
**KI-1294-00**  
 Satz, Set, Juego, Set



**SIMS**  
 12,5 cm, 5"  
**KI-0400-114**



**SIMS**  
 15,0 cm, 6"  
**KI-0400-115**



**SIMS**  
 17,5 cm, 7"  
**KI-0400-116**



**MATHIEU**  
 100 x 13-23 mm **KI-0400-117**  
 100 x 16-30 mm **KI-0400-118**



**MATHIEU**  
 100 x 11-21 mm **KI-0400-119**  
 100 x 14-27 mm **KI-0400-120**



**LANDAU**  
 100 x 28 mm **KI-0400-121**  
 100 x 38 mm **KI-0400-122**



Scheidenspekula  
 Vaginal Specula  
 Espéculos vaginales  
 Speculi vaginali



**BREISKY**

- 100 x 20 mm **KI-0400-123**
- 100 x 25 mm **KI-0400-124**
- 100 x 30 mm **KI-0400-125**
- 100 x 35 mm **KI-0400-126**
- 100 x 40 mm **KI-0400-127**
- 130 x 20 mm **KI-0400-128**
- 130 x 25 mm **KI-0400-129**
- 130 x 30 mm **KI-0400-130**
- 130 x 35 mm **KI-0400-131**
- 130 x 40 mm **KI-0400-132**
- 155 x 40 mm **KI-0400-133**

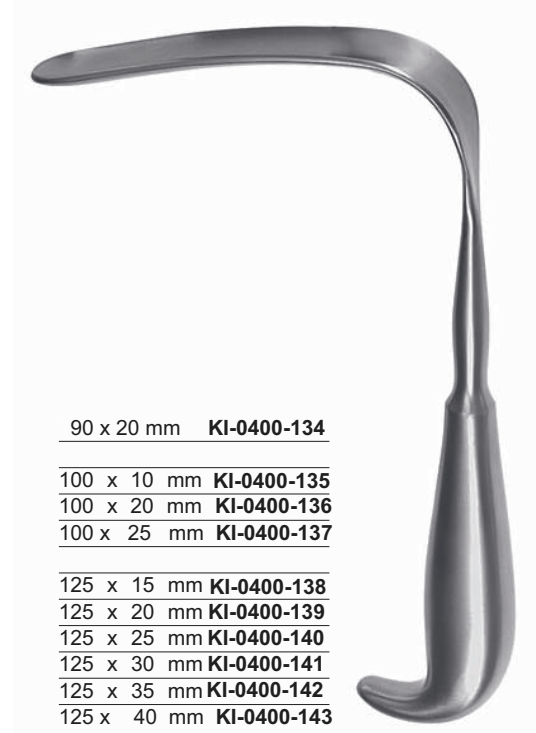

**MATZENAUER**

- 90 x 20 mm **KI-0400-134**
- 100 x 10 mm **KI-0400-135**
- 100 x 20 mm **KI-0400-136**
- 100 x 25 mm **KI-0400-137**
- 125 x 15 mm **KI-0400-138**
- 125 x 20 mm **KI-0400-139**
- 125 x 25 mm **KI-0400-140**
- 125 x 30 mm **KI-0400-141**
- 125 x 35 mm **KI-0400-142**
- 125 x 40 mm **KI-0400-143**



**BRAUN, MODIF.**  
 19,0 cm, 7 1/2"  
**KI-0400-144**



**DOYEN**  
 23,0 cm, 9"  
**KI-0400-145**



**DOYEN**  
 25,0 cm, 9"  
**KI-0400-146**



**WERTHEIM**  
 30,0 cm, 12"  
**KI-0400-147**

Endospekula, Lateral-Spekulum, Intrauterinsonde  
 Endospecula, Lateral Speculum, Intrauterine Probe  
 Endoespécucos, Espécuculo lateral, Sonda intra-uterina  
 Endospeculi, Speculo lateral, Sonde intrauterine

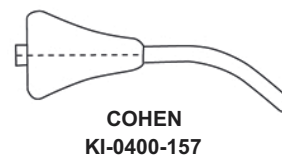
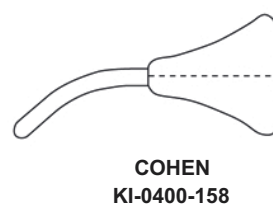
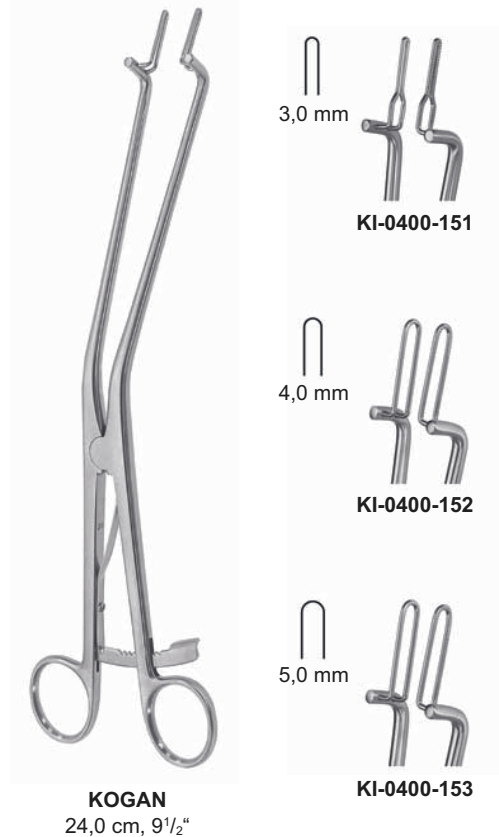

Uterus-Dilatatoren  
 Uterine Dilators  
 Dilatadores uterinos  
 Dilatatori uterini



**HEGAR**  
 18,5 cm, 7 1/4"

Ø 1,0 mm	<b>KI-0400-159</b>
Ø 2,0 mm	<b>KI-0400-160</b>
Ø 3,0 mm	<b>KI-0400-161</b>
Ø 4,0 mm	<b>KI-0400-162</b>
Ø 5,0 mm	<b>KI-0400-163</b>
Ø 6,0 mm	<b>KI-0400-164</b>
Ø 7,0 mm	<b>KI-0400-165</b>
Ø 8,0 mm	<b>KI-0400-166</b>
Ø 9,0 mm	<b>KI-0400-167</b>
Ø 10,0 mm	<b>KI-0400-168</b>
Ø 11,0 mm	<b>KI-0400-169</b>
Ø 12,0 mm	<b>KI-0400-170</b>
Ø 13,0 mm	<b>KI-0400-171</b>
Ø 14,0 mm	<b>KI-0400-172</b>
Ø 15,0 mm	<b>KI-0400-173</b>
Ø 16,0 mm	<b>KI-0400-174</b>
Ø 17,0 mm	<b>KI-0400-175</b>
Ø 18,0 mm	<b>KI-0400-176</b>
Ø 19,0 mm	<b>KI-0400-177</b>
Ø 20,0 mm	<b>KI-0400-178</b>
Ø 21,0 mm	<b>KI-0400-179</b>
Ø 22,0 mm	<b>KI-0400-180</b>
Ø 23,0 mm	<b>KI-0400-181</b>
Ø 24,0 mm	<b>KI-0400-182</b>
Ø 25,0 mm	<b>KI-0400-183</b>
Ø 26,0 mm	<b>KI-0400-184</b>



**HEGAR**  
 18,5 cm, 7 1/4"

Ø 1,5 mm	<b>KI-0400-185</b>
Ø 2,5 mm	<b>KI-0400-186</b>
Ø 3,5 mm	<b>KI-0400-187</b>
Ø 4,5 mm	<b>KI-0400-188</b>
Ø 5,5 mm	<b>KI-0400-189</b>
Ø 6,5 mm	<b>KI-0400-190</b>
Ø 7,5 mm	<b>KI-0400-191</b>
Ø 8,5 mm	<b>KI-0400-192</b>
Ø 9,5 mm	<b>KI-0400-193</b>
Ø 10,5 mm	<b>KI-0400-194</b>
Ø 11,5 mm	<b>KI-0400-195</b>
Ø 12,5 mm	<b>KI-0400-196</b>
Ø 13,5 mm	<b>KI-0400-197</b>
Ø 14,5 mm	<b>KI-0400-198</b>
Ø 15,5 mm	<b>KI-0400-199</b>
Ø 16,5 mm	<b>KI-0400-200</b>
Ø 17,5 mm	<b>KI-0400-201</b>



205 x 105 x 45 mm

**HEGAR**  
**KI-0400-202**  
 Satz, Set, Juego, Set  
 Ø 1,0 - Ø 26,0  
 (26 dilators)

**HEGAR**  
**KI-0400-203**  
 Satz, Set, Juego, Set  
 Ø 4,0 - Ø 17,0  
 (14 dilators)

Uterus-Dilatatoren  
 Uterine Dilators  
 Dilataores uterinos  
 Dilattatori uterini



**HEGAR**  
 20,0 cm, 8"

1,0 / 2,0 mm	<b>KI-0400-204</b>
Ø 3,0 / 4,0 mm	<b>KI-0400-205</b>
Ø 5,0 / 6,0 mm	<b>KI-0400-206</b>
Ø 7,0 / 8,0 mm	<b>KI-0400-207</b>
Ø 9,0 / 10,0 mm	<b>KI-0400-208</b>
Ø 11,0 / 12,0 mm	<b>KI-0400-209</b>
Ø 13,0 / 14,0 mm	<b>KI-0400-210</b>
Ø 15,0 / 16,0 mm	<b>KI-0400-211</b>
Ø 17,0 / 18,0 mm	<b>KI-0400-212</b>
Ø 19,0 / 20,0 mm	<b>KI-0400-213</b>
Ø 21,0 / 22,0 mm	<b>KI-0400-214</b>
Ø 23,0 / 24,0 mm	<b>KI-0400-215</b>
Ø 25,0 / 26,0 mm	<b>KI-0400-216</b>



**HEGAR**  
**KI-0400-217**  
 Satz, Set, Juego, Set  
 Ø 3,0 / 4,0 - Ø 17,0 / 18,0 mm  
 (8 dilators)

**HEGAR**  
**KI-0400-218**  
 Satz, Set, Juego, Set  
 Ø 1,0 / 2,0 - Ø 25,0 / 26,0 mm  
 (13 dilators)



**HANK**

Ø 4,5 / 5,0 mm	<b>KI-0400-219</b>
Ø 5,5 / 6,0 mm	<b>KI-0400-220</b>
Ø 6,5 / 7,0 mm	<b>KI-0400-221</b>
Ø 7,5 / 8,0 mm	<b>KI-0400-222</b>
Ø 8,5 / 9,0 mm	<b>KI-0400-223</b>
Ø 9,5 / 10,0 mm	<b>KI-0400-224</b>

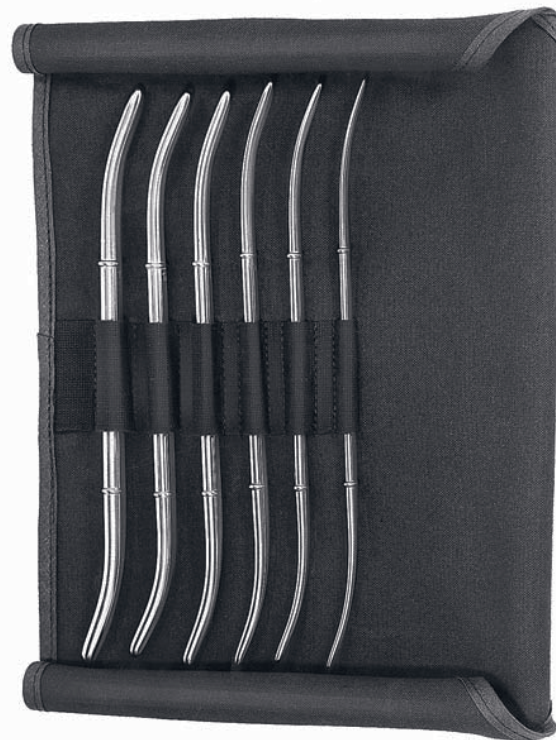

**HANK**  
**KI-0400-225**  
 Satz, Set, Juego, Set  
 Ø 4,5 / 5,0 - Ø 9,5 / 10,0 mm  
 (6 dilators)

Uterus-Dilatatoren, Hakenzangen  
 Uterine Dilators, Uterine Tenaculum Forceps  
 Dilatadores uterinos, Pinzas para coger el cuello del útero  
 Dilatatori uterini, Pinze per abbassare il collo dell'utero



**PRATT**

Ø 4,5 / 5,0 mm	<b>KI-0400-226</b>
Ø 5,5 / 6,0 mm	<b>KI-0400-227</b>
Ø 7,5 / 8,0 mm	<b>KI-0400-228</b>
Ø 8,5 / 9,0 mm	<b>KI-0400-229</b>
Ø 9,5 / 10,0 mm	<b>KI-0400-230</b>
Ø 11,5 / 12,0 mm	<b>KI-0400-231</b>
Ø 12,5 / 13,0 mm	<b>KI-0400-232</b>
Ø 13,5 / 14,0 mm	<b>KI-0400-233</b>



**PRATT**  
**KI-0400-234**

Satz, Set, Juego, Set  
 Ø 4,5 / 5,0 - Ø 13,5 / 14,0 mm  
 (8 dilators)



**BARRETT**  
 18,0 cm, 7"  
**KI-0400-235**

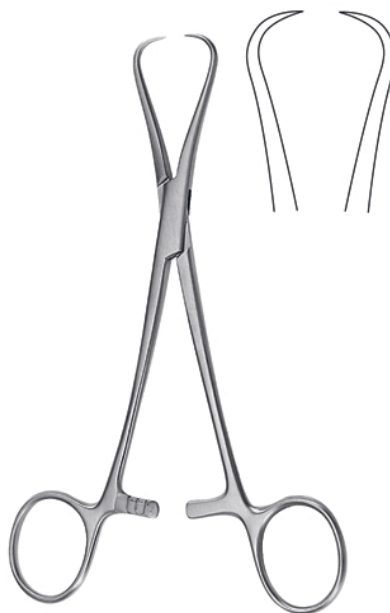

**ADAIR**  
 19,0 cm, 7½"  
**KI-0400-236**



**STAUDE-MOORE**  
 17,0 cm, 6¾"  
**KI-0400-237**

**Hakenzangen**  
**Uterine Tenaculum Forceps**  
Pinzas para coger el cuello del útero  
Pinze per abbassare il collo dell'utero

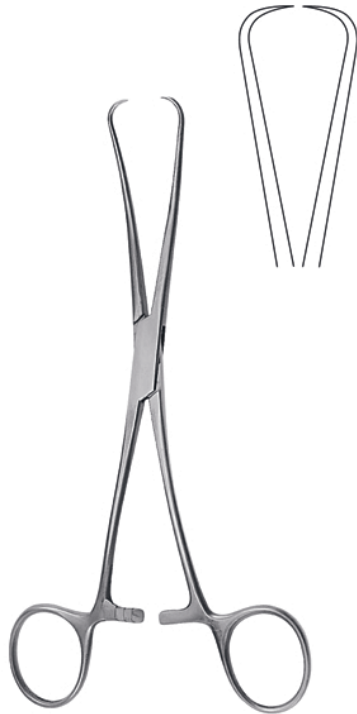

**JARCHO**  
20,0 cm, 8"  
KI-0400-238



**SCHROEDER**  
25,0 cm, 9<sup>3</sup>/<sub>4</sub>"  
KI-0400-239



**BRAUN**  
25,0 cm, 9<sup>3</sup>/<sub>4</sub>"  
KI-0400-240



**DUPLAY**  
28,0 cm, 11"  
KI-0400-241



**POZZI**  
26,0 cm, 10<sup>1</sup>/<sub>4</sub>"  
KI-0400-242



**KAHN**  
24,0 cm, 9<sup>1</sup>/<sub>2</sub>"  
KI-0400-243

Hakenzangen  
 Uterine Tenaculum Forceps  
 Pinzas para coger el cuello del útero  
 Pinze per abbassare il collo dell'utero



**SKENE**  
 24,0 cm, 9 1/2"  
 KI-0400-244



**SCHROEDER**  
 24,0 cm, 9 1/2"  
 KI-0400-245



**SCHROEDER**  
 24,0 cm, 9 1/2"  
 KI-0400-246



**TEALE**  
 23,0 cm, 9"  
 KI-0400-247



**JACOBS**  
 21,0 cm, 8 1/2"  
 KI-0400-248



**JACOBS**  
 21,0 cm, 8 1/2"  
 KI-0400-249

**Hakenzangen**  
**Uterine Tenaculum Forceps**  
 Pinzas para coger el cuello del útero  
 Pinze per abbassare il collo dell'utero



**MUSEUX**  
 24,0 cm, 9 1/2"

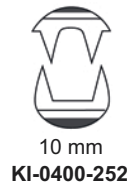

**MUSEUX**  
 24,0 cm, 9 1/2"

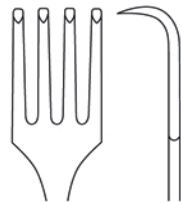
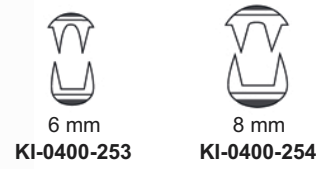

**BRAUN**  
 15,5 cm, 6"  
 KI-0400-256

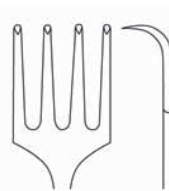

**CZERNY**  
 20,5 cm, 8"  
 KI-0400-257



**PRATT**  
 28,0 cm, 11"  
 KI-0400-258



**IOWA**  
 26,0 cm, 10 1/4"  
 KI-0400-259



Polypen- und Ovarienzangen, Uterusfaßzangen  
 Polypus and Ovum Forceps, Uterine Elevating Forceps  
 Pinzas para pólipos uterinos y ovarios, Pinzas para la útero  
 Pinze per polipi e ovaie, Pinze per affarrare l'utero



**DOYEN**  
 20,5 cm, 8"  
 KI-0400-260

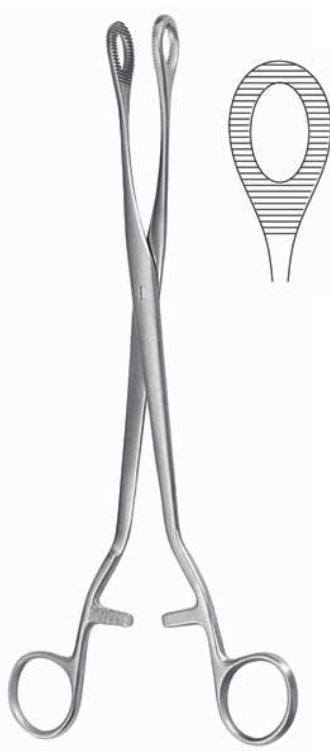

**NOTO**  
 27,0 cm, 10<sup>5</sup>/<sub>8</sub>"  
 KI-0400-261

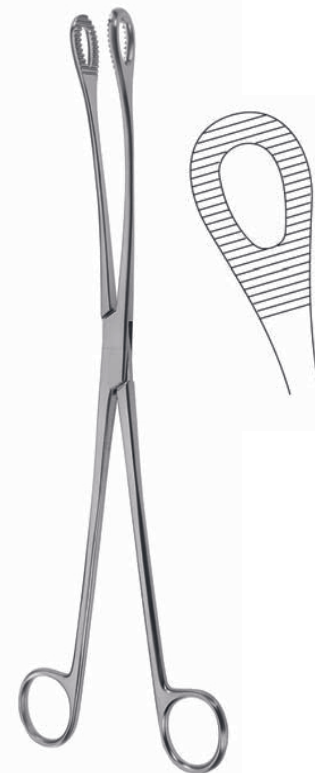

**KELLY**  
 32,0 cm, 12<sup>1</sup>/<sub>2</sub>"  
 KI-0400-262



**HEYWOOD-SMITH**  
 25,0 cm, 9<sup>3</sup>/<sub>4</sub>"  
 KI-0400-263



**DARTIGUES**  
 27,0 cm, 10<sup>3</sup>/<sub>4</sub>"  
 KI-0400-264



**SOMER**  
 23,0 cm, 9"  
 KI-0400-265

Uterusfaßzangen, Uterussonden, Zentimetereinteilung  
 Uterine Elevating Forceps, Uterine Probes, graduated in centimeters  
 Pinzas para la útero, Histerómetros, graduado en centímetros  
 Pinze per affarrare l'utero, Isterometri, graduato in cm



**COLLIN**  
 25,0 cm, 9<sup>3</sup>/<sub>4</sub>"  
 KI-0400-266



**BEACHAM**  
 26,0 cm, 10<sup>1</sup>/<sub>4</sub>"  
 KI-0400-267

Amniotom  
 Amniotome  
 Amniótomo  
 Amniotomo



**BRAUN**  
 28,0 cm, 11"  
 KI-0400-268

Uterus-Depressor  
 Uterine depressor  
 Depresor uterino  
 Depressori uterini



**SIMS**  
 32,0 cm, 12<sup>1</sup>/<sub>2</sub>"  
 KI-0400-269

biegsam  
 malleable  
 maleable  
 malleabile



**SIMS**  
 32,0 cm, 12<sup>1</sup>/<sub>2</sub>"  
 KI-0400-270



**MARTIN**  
 32,0 cm, 12<sup>1</sup>/<sub>2</sub>"  
 KI-0400-271



**MARTIN**  
 32,0 cm, 12<sup>1</sup>/<sub>2</sub>"  
 KI-0400-272

biegsam  
 malleable  
 maleable  
 malleabile



**VALLEIX**  
 25,0 cm, 10"  
 KI-0400-273

Ø 4 mm



**SIMPSON**  
 29,0 cm, 11<sup>1</sup>/<sub>2</sub>"  
 KI-0400-274

biegsam  
 malleable  
 maleable  
 malleabile

Ø 4 mm



**COLLIN**  
 28,0 cm, 11"  
 KI-0400-275

# General Surgery Instruments



"Supporting Healthcare"  
**KAHA INDUSTRIES**  
 Manufacturer Of Dental & Surgical Instruments

Biopsieküretten  
 Biopsy Curettes  
 Curetas para biopsia  
 Curette per biopsia



**KEVORKIAN**  
 30,0 cm, 12"  
 KI-0400-276



**KEVORKIAN**  
 30,0 cm, 12"  
 KI-0400-277



**KEVORKIAN**  
 30,0 cm, 12"  
 KI-0400-278

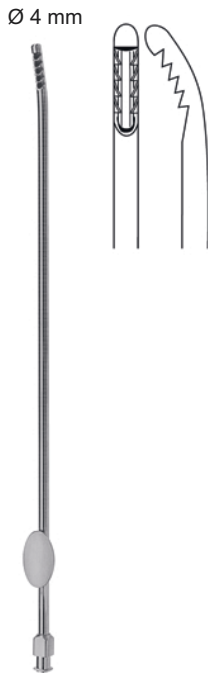

**NOVAK**  
 23,0 cm, 9"  
 KI-0400-279

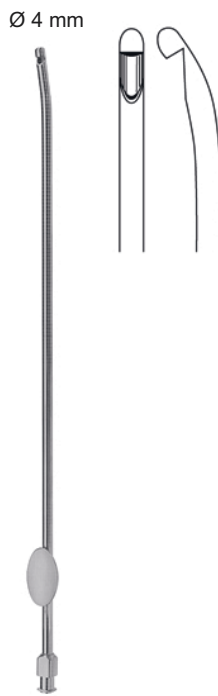

**RANDALL**  
 23,0 cm, 9"  
 KI-0400-280



**MILAN**  
 29,0 cm, 11½"



Ø 4 mm  
 KI-0400-281

Ø 4 mm  
 KI-0400-282

Ø 4 mm  
 KI-0400-283

Myominstrumente  
 Myoma Instruments  
 Instrumentos para mioma  
 Strumenti per fibroma



**UTERUSPERFORATOR**  
 25,0 cm, 9<sup>3</sup>/<sub>4</sub>"  
 KI-0400-284



**FISTELHAKEN**  
 25,0 cm, 9<sup>3</sup>/<sub>4</sub>"  
 KI-0400-285



**SIMON**  
 22,0 cm, 8<sup>5</sup>/<sub>8</sub>"  
 KI-0400-286



**EMMETT**  
 22,0 cm, 8<sup>5</sup>/<sub>8</sub>"



KI-0400-287



KI-0400-288



KI-0400-289



KI-0400-290



KI-0400-291



**SEGOND**  
 27,0 cm, 10<sup>5</sup>/<sub>8</sub>"  
 KI-0400-292



**AYRE**  
 23,0 cm, 9"  
 KI-0400-293

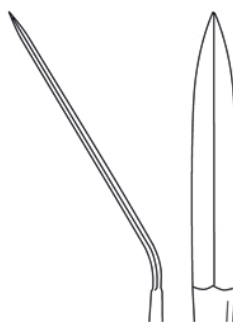

**DOYEN**  
 19,0 cm, 7<sup>1</sup>/<sub>2</sub>"  
 KI-0400-294

**DOYEN**  
 17,0 cm, 6<sup>3</sup>/<sub>4</sub>"  
 KI-0400-295

**Uterusküretten**  
**Uterine Curettes**  
**Curetas uterinas**  
**Curette uterine**

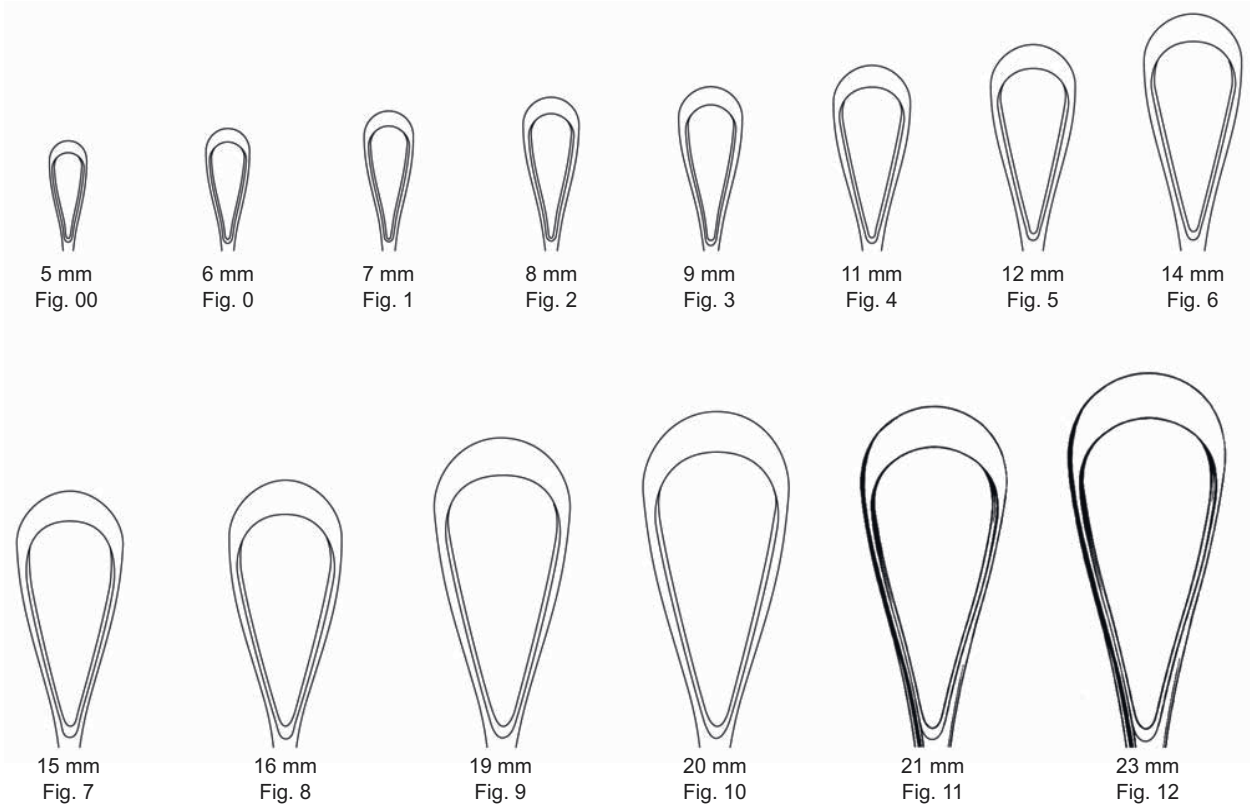

scharf, fest  
 sharp, rigid  
 cortantes, rígidas  
 acute, rigide

Fig. 00	KI-0400-296
Fig. 0	KI-0400-297
Fig. 1	KI-0400-298
Fig. 2	KI-0400-299
Fig. 3	KI-0400-300
Fig. 4	KI-0400-301
Fig. 5	KI-0400-302
Fig. 6	KI-0400-303
Fig. 7	KI-0400-304
Fig. 8	KI-0400-305
Fig. 9	KI-0400-306
Fig. 10	KI-0400-307
Fig. 11	KI-0400-308
Fig. 12	KI-0400-309

**RECAMIER**  
 26,0 cm, 10<sup>1</sup>/<sub>4</sub>"



scharf, biegsam  
 sharp, malleable  
 cortantes, maleable  
 acute, malleabile

Fig. 00	KI-0400-310
Fig. 0	KI-0400-311
Fig. 1	KI-0400-312
Fig. 2	KI-0400-313
Fig. 3	KI-0400-314
Fig. 4	KI-0400-315
Fig. 5	KI-0400-316
Fig. 6	KI-0400-317
Fig. 7	KI-0400-318
Fig. 8	KI-0400-319
Fig. 9	KI-0400-320
Fig. 10	KI-0400-321
Fig. 11	KI-0400-322
Fig. 12	KI-0400-323

**RECAMIER**  
 26,0 cm, 10<sup>1</sup>/<sub>4</sub>"

**Uterusküretten**  
**Uterine Curettes**  
**Curetas uterinas**  
**Curette uterine**

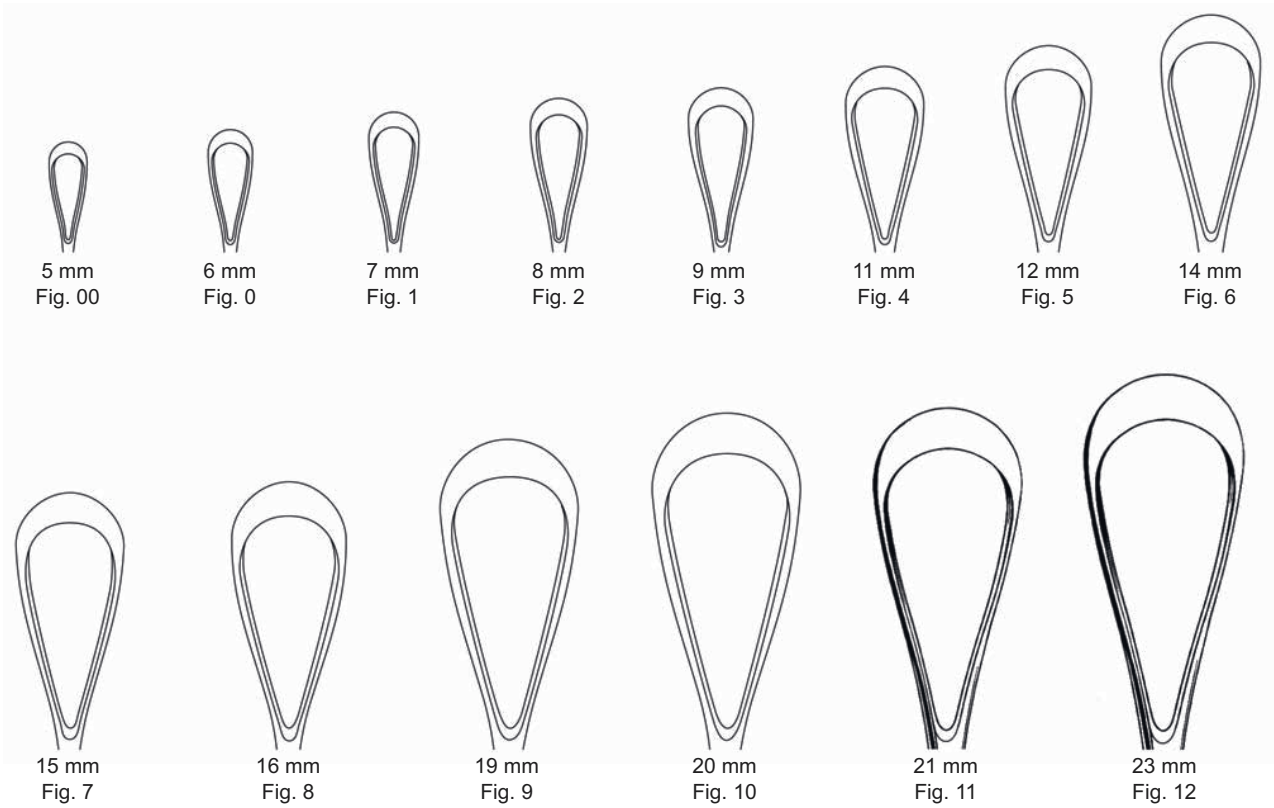

scharf, fest  
 sharp, rigid  
 cortantes, rígidas  
 acute, rigide

- |         |                    |
|---------|--------------------|
| Fig. 00 | <b>KI-0400-324</b> |
| Fig. 0  | <b>KI-0400-325</b> |
| Fig. 1  | <b>KI-0400-326</b> |
| Fig. 2  | <b>KI-0400-327</b> |
| Fig. 3  | <b>KI-0400-328</b> |
| Fig. 4  | <b>KI-0400-329</b> |
| Fig. 5  | <b>KI-0400-330</b> |
| Fig. 6  | <b>KI-0400-331</b> |
| Fig. 7  | <b>KI-0400-332</b> |
| Fig. 8  | <b>KI-0400-333</b> |
| Fig. 9  | <b>KI-0400-334</b> |
| Fig. 10 | <b>KI-0400-335</b> |
| Fig. 11 | <b>KI-0400-336</b> |
| Fig. 12 | <b>KI-0400-337</b> |

**SIMS**  
 26,0 cm, 10<sup>1</sup>/<sub>4</sub>"



scharf, biegsam  
 sharp, malleable  
 cortantes, maleable  
 acute, malleabile

- |         |                    |
|---------|--------------------|
| Fig. 00 | <b>KI-0400-338</b> |
| Fig. 0  | <b>KI-0400-339</b> |
| Fig. 1  | <b>KI-0400-340</b> |
| Fig. 2  | <b>KI-0400-341</b> |
| Fig. 3  | <b>KI-0400-342</b> |
| Fig. 4  | <b>KI-0400-343</b> |
| Fig. 5  | <b>KI-0400-344</b> |
| Fig. 6  | <b>KI-0400-345</b> |
| Fig. 7  | <b>KI-0400-346</b> |
| Fig. 8  | <b>KI-0400-347</b> |
| Fig. 9  | <b>KI-0400-348</b> |
| Fig. 10 | <b>KI-0400-349</b> |
| Fig. 11 | <b>KI-0400-350</b> |
| Fig. 12 | <b>KI-0400-351</b> |

**SIMS**  
 26,0 cm, 10<sup>1</sup>/<sub>4</sub>"

Uterusküretten  
 Uterine Curettes  
 Curetas uterinas  
 Curette uterine

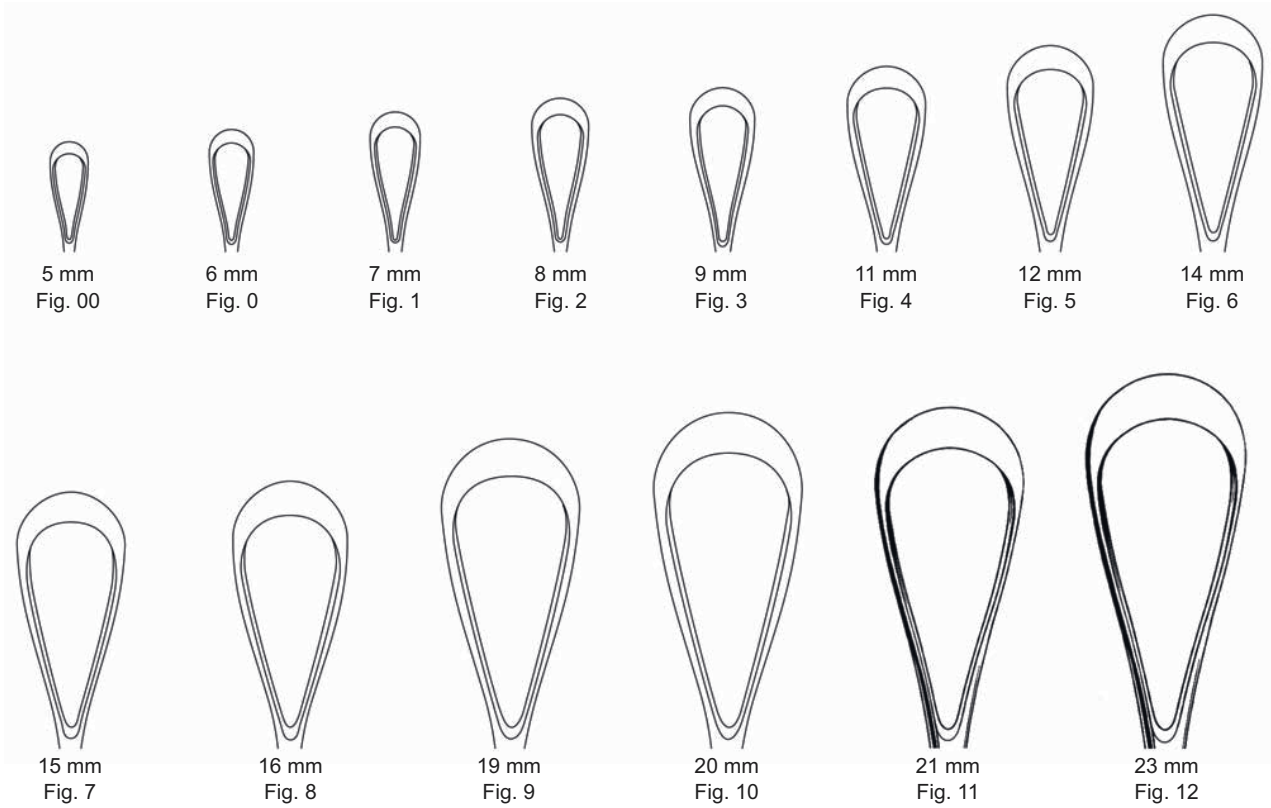

scharf, fest  
 sharp, rigid  
 cortantes, rígidas  
 acute, rigide

Fig. 00	KI-0400-352
Fig. 0	KI-0400-353
Fig. 1	KI-0400-354
Fig. 2	KI-0400-355
Fig. 3	KI-0400-356
Fig. 4	KI-0400-357
Fig. 5	KI-0400-358
Fig. 6	KI-0400-359
Fig. 7	KI-0400-360
Fig. 8	KI-0400-361
Fig. 9	KI-0400-362
Fig. 10	KI-0400-363
Fig. 11	KI-0400-364
Fig. 12	KI-0400-365

**RECAMIER**  
 31,0 cm, 12<sup>1</sup>/<sub>4</sub>"



scharf, biegsam  
 sharp, malleable  
 cortantes, maleable  
 acute, malleabile

Fig. 00	KI-0400-366
Fig. 0	KI-0400-367
Fig. 1	KI-0400-368
Fig. 2	KI-0400-369
Fig. 3	KI-0400-370
Fig. 4	KI-0400-371
Fig. 5	KI-0400-372
Fig. 6	KI-0400-373
Fig. 7	KI-0400-374
Fig. 8	KI-0400-375
Fig. 9	KI-0400-376
Fig. 10	KI-0400-377
Fig. 11	KI-0400-378
Fig. 12	KI-0400-379

**RECAMIER**  
 31,0 cm, 12<sup>1</sup>/<sub>4</sub>"

**Uterusküretten**  
**Uterine Curettes**  
**Curetas uterinas**  
**Curette uterine**

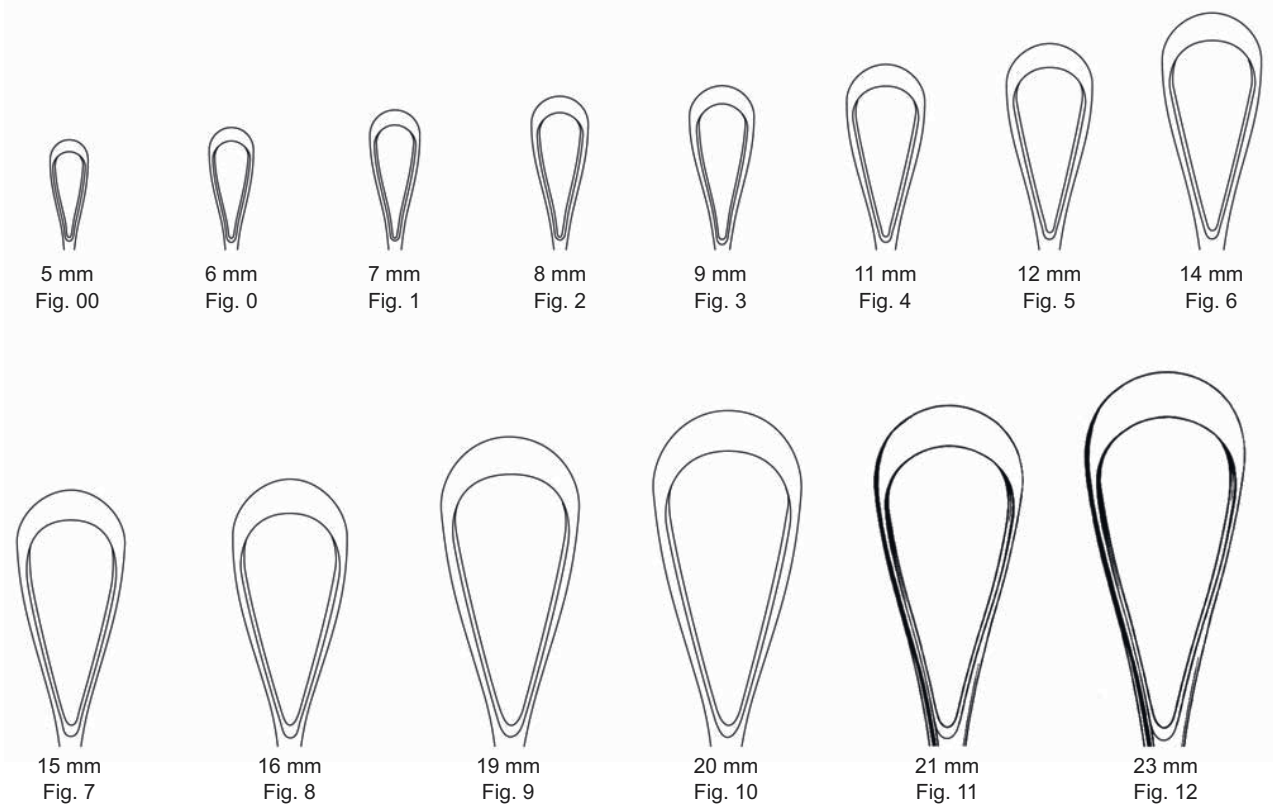

scharf, fest  
 sharp, rigid  
 cortantes, rígidas  
 acute, rigide

Fig. 00	KI-0400-380
Fig. 0	KI-0400-381
Fig. 1	KI-0400-382
Fig. 2	KI-0400-383
Fig. 3	KI-0400-384
Fig. 4	KI-0400-385
Fig. 5	KI-0400-386
Fig. 6	KI-0400-387
Fig. 7	KI-0400-388
Fig. 8	KI-0400-389
Fig. 9	KI-0400-390
Fig. 10	KI-0400-391
Fig. 11	KI-0400-392
Fig. 12	KI-0400-393

**SIMS**  
 31,0 cm, 12 1/4"



scharf, biegsam  
 sharp, malleable  
 cortantes, maleable  
 acute, malleabile

Fig. 00	KI-0400-394
Fig. 0	KI-0400-395
Fig. 1	KI-0400-396
Fig. 2	KI-0400-397
Fig. 3	KI-0400-398
Fig. 4	KI-0400-399
Fig. 5	KI-0400-400
Fig. 6	KI-0400-401
Fig. 7	KI-0400-402
Fig. 8	KI-0400-403
Fig. 9	KI-0400-404
Fig. 10	KI-0400-405
Fig. 11	KI-0400-406
Fig. 12	KI-0400-407

**SIMS**  
 31,0 cm, 12 1/4"



Uterusküretten  
 Uterine Curettes  
 Curetas uterinas  
 Curette uterine

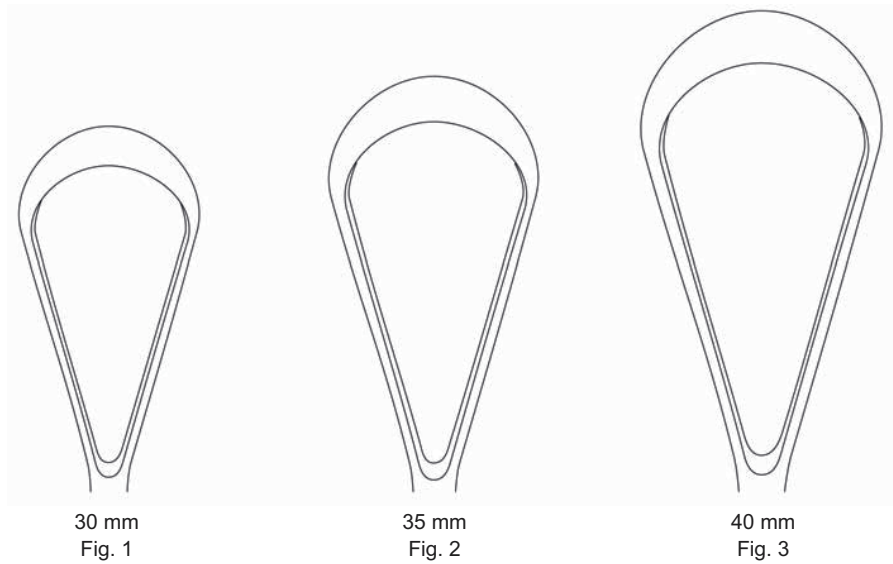

scharf, fest  
 sharp, rigid  
 cortantes, rígidas  
 acute, rigide

Fig. 1 **KI-0400-408**  
 Fig. 2 **KI-0400-409**  
 Fig. 3 **KI-0400-410**

**SIMS**  
 31,0 cm, 12<sup>1</sup>/<sub>4</sub>"



scharf, biegsam  
 sharp, malleable  
 cortantes, maleable  
 acute, malleabile

Fig. 1 **KI-0400-411**  
 Fig. 2 **KI-0400-412**  
 Fig. 3 **KI-0400-413**

**SIMS**  
 31,0 cm, 12<sup>1</sup>/<sub>4</sub>"

Uterusküretten  
 Uterine Curettes  
 Curetas uterinas  
 Curette uterine

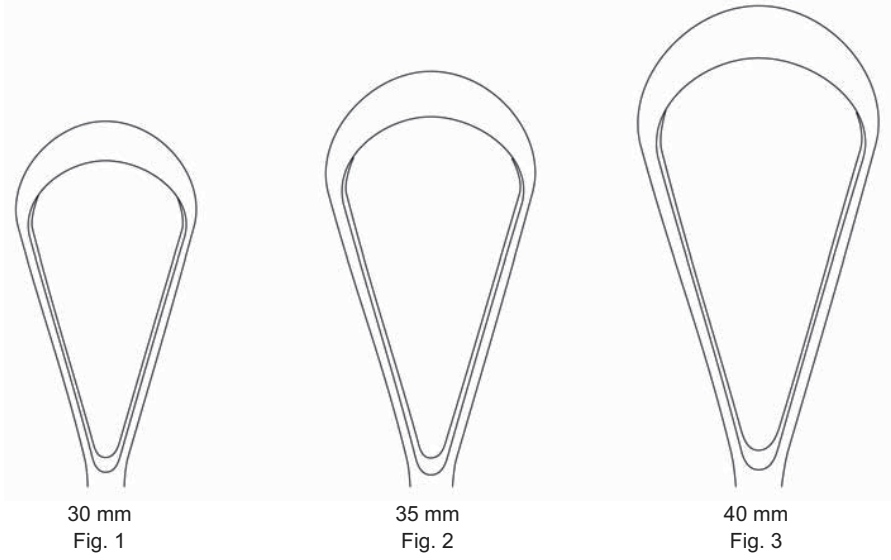

scharf, fest  
 sharp, rigid  
 cortantes, rígidas  
 acute, rigide

Fig. 1 **KI-0400-414**  
 Fig. 2 **KI-0400-415**  
 Fig. 3 **KI-0400-416**

**BUMM**  
 31,0 cm, 12 1/4"



scharf, biegsam  
 sharp, malleable  
 cortantes, maleable  
 acute, malleabile

Fig. 1 **KI-0400-417**  
 Fig. 2 **KI-0400-418**  
 Fig. 3 **KI-0400-419**

**BUMM**  
 31,0 cm, 12 1/4"

Uteruslöffel, Uterus-Biopsiezangen  
 Uterine Scoopes, Cervical Biopsy and Specimen Forceps  
 Cucharillas uterinas, Pinzas saca-bocados para biopsia  
 Curette uterine, Pinze per la biopsia cervicale e da prelievo

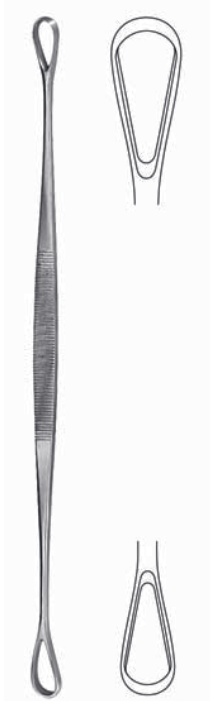

**BLAKE**  
 27,0 cm, 10<sup>5</sup>/<sub>8</sub>"  
 KI-0400-420



**SIMON**  
 25,0 cm, 9<sup>3</sup>/<sub>4</sub>"

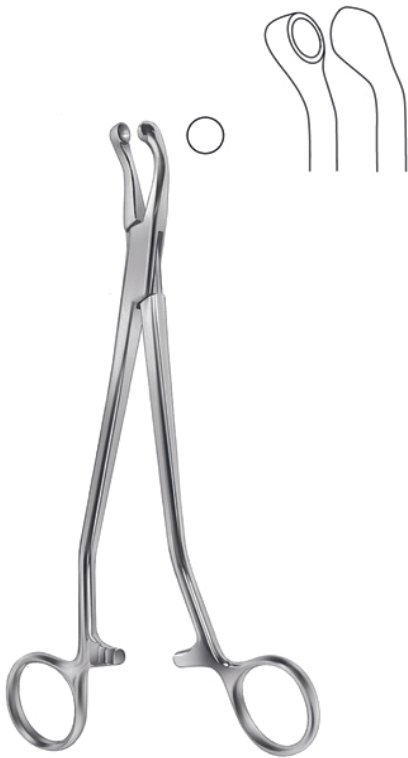
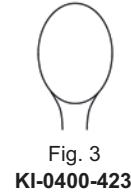
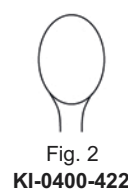
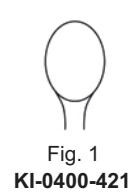

**THOMS-GAYLOR**  
 22,0 cm, 8<sup>5</sup>/<sub>8</sub>" KI-0400-427  
 24,0 cm, 9<sup>1</sup>/<sub>2</sub>" KI-0400-428

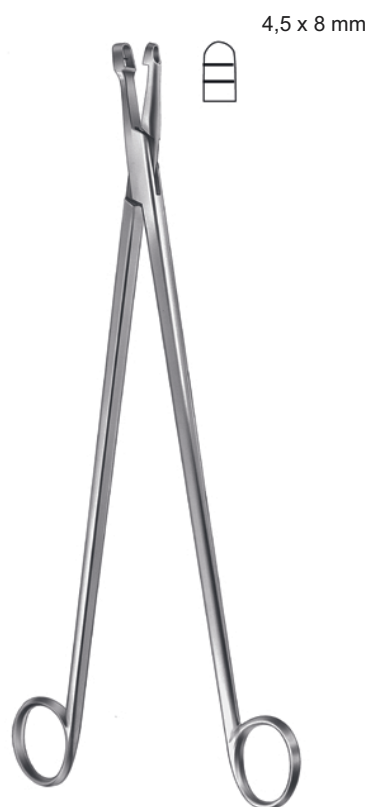

29,0 cm, 11<sup>1</sup>/<sub>2</sub>" KI-0400-429



**SCHUMACHER-VAN DOREN**  
 24,0 cm, 9<sup>1</sup>/<sub>2</sub>"  
 KI-0400-430

**Uterus-Biopsiezangen**  
**Cervical Biopsy and Specimen Forceps**  
**Pinzas saca-bocados para biopsia**  
**Pinze per la biopsia cervicale e da prelievo**



**THOMS-GAYLOR**  
 24,0 cm, 9½"  
 KI-0400-431



**FAURE**  
 21,0 cm, 8¼"  
 KI-0400-432



**SCHUBERT**  
 26,0 cm, 10¼"  
 KI-0400-433

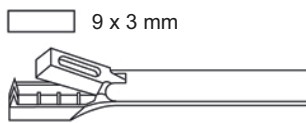
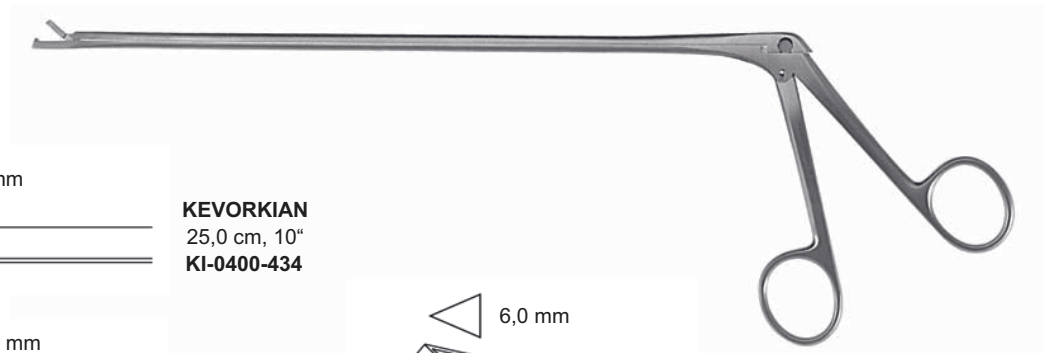

**KEVORKIAN**  
 25,0 cm, 10"  
 KI-0400-434

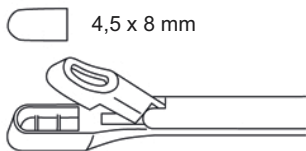

**EPPENDORFER**  
 20,0 cm, 8"  
 KI-0400-435

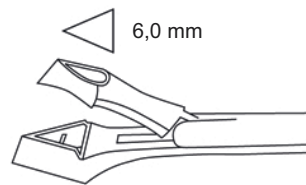

**SCHUMACHER**  
 24,0 cm, 9½"  
 KI-0400-438

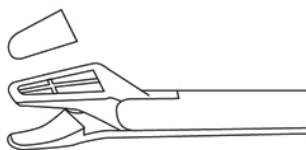

**ALEXANDER**  
 28,0 cm, 11"  
 KI-0400-436

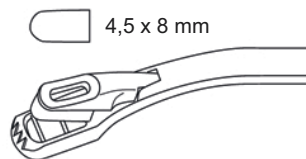

**WITTNER**  
 23,0 cm, 9"  
 KI-0400-439

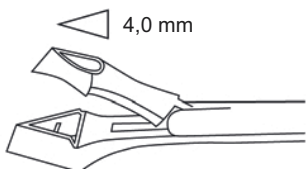

**SCHUMACHER**  
 24,0 cm, 9½"  
 KI-0400-437

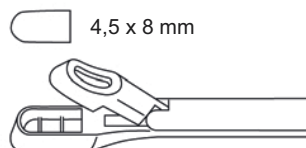

**WITTNER**  
 23,0 cm, 9"  
 KI-0400-440

Uterus-Biopsiezangen  
 Cervical Biopsy and Specimen Forceps  
 Pinzas saca-bocados para biopsia  
 Pinze per la biopsia cervicale e da prelievo

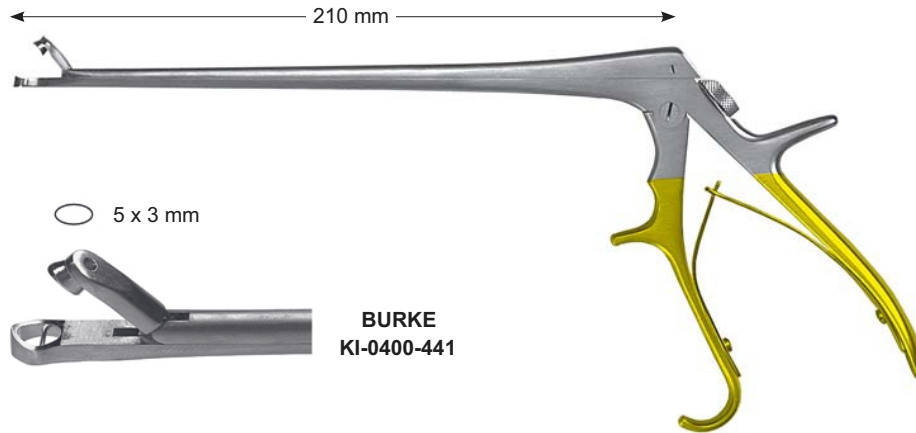

Geburtszangen  
Obstetrical Forceps  
Fórceps para obstétrica  
Forbici per ostetricia



**WRIGLEY**  
28,0 cm, 11"  
KI-0400-447



**SIMPSON**  
30,0 cm, 11<sup>3</sup>/<sub>4</sub>"  
KI-0400-448



**SIMPSON-BRAUN**  
33,0 cm, 13"  
KI-0400-449



**SIMPSON-BRAUN**  
36,0 cm, 14<sup>1</sup>/<sub>8</sub>"  
KI-0400-450



**SIMPSON-LUIKART**  
36,0 cm, 14<sup>1</sup>/<sub>8</sub>"  
KI-0400-451



**DE LEE**  
30,0 cm, 11<sup>3</sup>/<sub>4</sub>"  
KI-0400-452



**DE LEE**  
36,0 cm, 14<sup>1</sup>/<sub>8</sub>"  
KI-0400-453



**DE LEE**  
38,0 cm, 15<sup>5</sup>/<sub>8</sub>"  
KI-0400-454

# General Surgery Instruments



"Supporting Healthcare"  
**KAHA INDUSTRIES**  
Manufacturer Of Dental & Surgical Instruments

Geburtszangen  
Obstetrical Forceps  
Fórceps para obstétrica  
Forbici per ostetricia



**MC LEAN**  
36,0 cm, 14<sup>1</sup>/<sub>8</sub>"  
KI-0400-455



**KIELAND**  
41,0 cm, 16"  
KI-0400-456



**KIELAND-LUIKART**  
40,0 cm, 15<sup>3</sup>/<sub>4</sub>"  
KI-0400-457



**PIPER**  
44,0 cm, 17<sup>1</sup>/<sub>4</sub>"  
KI-0400-458



**ELLIOT**  
32,0 cm, 12<sup>1</sup>/<sub>2</sub>"  
KI-0400-459



**ELLIOT**  
38,0 cm, 15"  
KI-0400-460



**NAEGELE**  
36,0 cm, 14<sup>1</sup>/<sub>8</sub>"  
KI-0400-461



**NAEGELE**  
40,0 cm, 15<sup>3</sup>/<sub>4</sub>"  
KI-0400-462

Geburtszangen, Plazentar- und Abortuszangen  
 Obstetrical Forceps, Placenta and Ovum Forceps  
 Fórceps para obstétrica, Pinzas para aborto y placenta  
 Forbici per ostetricia, Pinze per placenta e per ovaie



**GREEN-ARMYTAGE**  
 21,0 cm, 8<sup>1</sup>/<sub>4</sub>"  
 KI-0400-463



**PESTALOZZA**  
 30,0 cm, 11<sup>3</sup>/<sub>4</sub>"  
 KI-0400-464



**SAENGER**  
 27,0 cm, 10<sup>5</sup>/<sub>8</sub>"  
 KI-0400-465



**SAENGER**  
 27,0 cm, 10<sup>5</sup>/<sub>8</sub>"  
 KI-0400-466



**WINTER**  
 28,0 cm, 11"



Fig. 1  
 KI-0400-467



Fig. 2  
 KI-0400-468



Fig. 3  
 KI-0400-469



Fig. 1  
 KI-0400-470



Fig. 2  
 KI-0400-471



Fig. 3  
 KI-0400-472



# General Surgery Instruments



"Supporting Healthcare"  
**KAHA INDUSTRIES**  
Manufacturer Of Dental & Surgical Instruments

Plazentar- und Abortuszangen  
Placenta and Ovum Forceps  
Pinzas para aborto y placenta  
Pinze per placenta e per ovaie

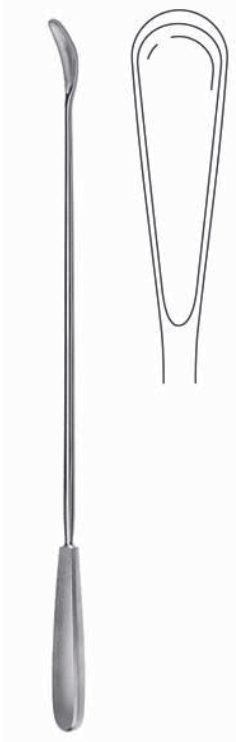

**WALLICH**  
42,0 cm, 16½"  
KI-0400-473



**MARTIN**  
34,0 cm, 13¾"  
KI-0400-474



**BIERER**  
33,0 cm, 13"  
KI-0400-475



**BIERER**  
33,0 cm, 13"  
KI-0400-476



**BIERER**  
33,0 cm, 13"  
KI-0400-477



**BIERER**  
33,0 cm, 13"  
KI-0400-478



“Supporting Healthcare”

**KAAHA INDUSTRIES**

Manufacturer Of Dental & Surgical Instruments

**C13**

**282 to 285**



**Vorbereitung, Dermatologie**

**Preparation, Dermatology**

**Preparación, Dermatología**

**Preparazione, Dermatologia**

Hautstanzen, Nagel Instrumente  
 Dermal Punches, Nail Instruments  
 Trépanos cutáneos, Instrumentos para uñas  
 Trapani dermatici, Strumenti per unghie



Lupusküretten  
 Lupus curettes  
 Curetas para lupus  
 Raschiatoio per lupus

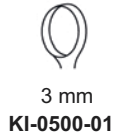

**PIFFARD**  
 14,0 cm, 5<sup>3</sup>/<sub>4</sub>"



**KEYES**  
 12,0 cm, 4<sup>3</sup>/<sub>4</sub>"

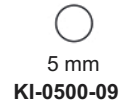
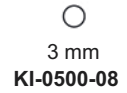
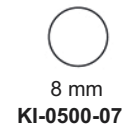
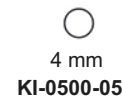
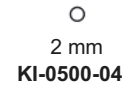

**KEYES**  
 12,0 cm, 4<sup>3</sup>/<sub>4</sub>"  
**KI-0500-11**

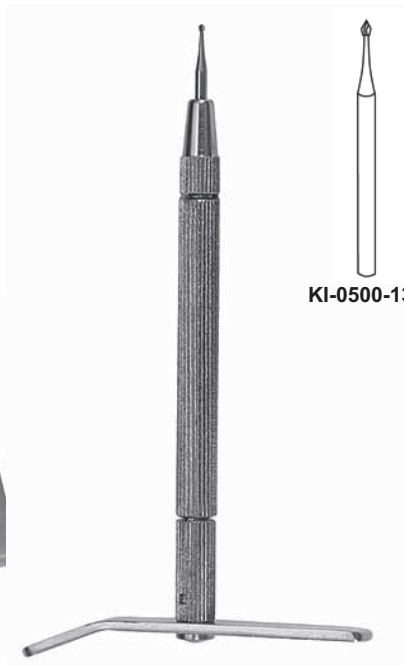

**NAGELBOHRER**  
**KI-0500-12**  
 komplett, complete,  
 completo, completo

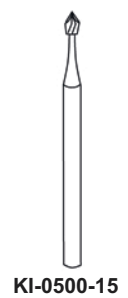
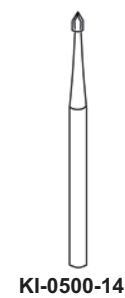

Komedonenquetscher  
 Comedo Extractors  
 Saca-comedones  
 Tiracomedoni



**UNNA**  
 14,0 cm, 5<sup>3</sup>/<sub>4</sub>"  
 KI-0500-16



**UNNA**  
 14,0 cm, 5<sup>3</sup>/<sub>4</sub>"  
 KI-0500-17



**SAALFELD**  
 10,0 cm, 4"  
 KI-0500-18



**SAALFELD**  
 14,0 cm, 5<sup>3</sup>/<sub>4</sub>"  
 KI-0500-19



**SCHAMBERG**  
 10,0 cm, 4"  
 KI-0500-20



**WALTON**  
 14,0 cm, 5<sup>3</sup>/<sub>4</sub>"  
 KI-0500-21



**FOX**  
 14,0 cm, 5<sup>3</sup>/<sub>4</sub>"

- 3 mm  
KI-0500-22
- 4 mm  
KI-0500-24
- 5 mm  
KI-0500-23
- 6 mm  
KI-0500-25

Lupusküretten  
 Lupus curettes  
 Curetas para lupus  
 Raschiatoio per lupus

Nagel Instrumente  
 Nail Instruments  
 Instruments para uñas  
 Strumenti per unghie



059-1420-01

**FINGERRINGSÄGE**  
 17,0 cm, 6<sup>3</sup>/<sub>4</sub>"  
 KI-0500-26



059-1430-01

**WALTON**  
 16,0 cm, 6<sup>1</sup>/<sub>4</sub>"  
 KI-0500-27



**RADOLF**  
 13,5 cm, 5<sup>3</sup>/<sub>8</sub>"  
 KI-0500-28



**NAGELZANGE**  
 13,5 cm, 5<sup>3</sup>/<sub>8</sub>"  
 KI-0500-29



**NAGELZANGE**  
 13,0 cm, 5"  
 KI-0500-30



**NAGELZANGE**  
 14,0 cm, 5<sup>1</sup>/<sub>2</sub>"

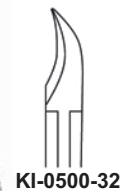
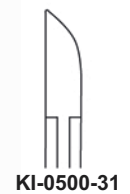

KI-0500-31

KI-0500-32



“Supporting Healthcare”

**KAAHA INDUSTRIES**

Manufacturer Of Dental & Surgical Instruments

**C14**  
286 to 295

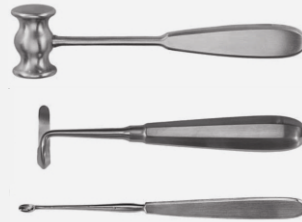

**Knochenchirurgie**

**Bone Surgery**

**Cirurgía ósea**































**Chirurgia ossea**

# General Surgery Instruments



"Supporting Healthcare"  
**KAHA INDUSTRIES**  
 Manufacturer Of Dental & Surgical Instruments

Scharfe Löffel  
 Bone Curettes  
 Cucharillas cortantes  
 Curetta per ossa

		
	Fig. 0000 KI-0600-08	Fig. 0000 KI-0600-18
		
	Fig. 000 KI-0600-09	Fig. 000 KI-0600-19
		
Fig. 000 KI-0600-01	Fig. 00 KI-0600-10	Fig. 00 KI-0600-20
		
Fig. 00 KI-0600-02	Fig. 0 KI-0600-11	Fig. 0 KI-0600-21
		
Fig. 0 KI-0600-03	Fig. 1 KI-0600-12	Fig. 1 KI-0600-22
		
Fig. 0 KI-0600-03	Fig. 2 KI-0600-13	Fig. 2 KI-0600-23
		
Fig. 1 KI-0600-04	Fig. 3 KI-0600-14	Fig. 3 KI-0600-24
		
Fig. 2 KI-0600-05	Fig. 4 KI-0600-15	Fig. 4 KI-0600-25
		
Fig. 3 KI-0600-06	Fig. 5 KI-0600-16	Fig. 5 KI-0600-26
		
Fig. 4 KI-0600-07	Fig. 6 KI-0600-17	Fig. 6 KI-0600-27
		
<b>SCHEDE</b> 17,0 cm, 6 <sup>3</sup> / <sub>4</sub> "	<b>VOLKMANN</b> 17,0 cm, 6 <sup>3</sup> / <sub>4</sub> "	<b>BRUNS</b> 17,0 cm, 6 <sup>3</sup> / <sub>4</sub> "

Scharfe Löffel  
 Bone Currettes  
 Cucharillas cortantes  
 Curetta per ossa

Fig. 00000  
**KI-0600-28**

Fig. 0000  
**KI-0600-29**

Fig. 000  
**KI-0600-30**

Fig. 00  
**KI-0600-31**

Fig. 0  
**KI-0600-32**



**LEMPERT**  
 21,5 cm, 8½"



**HALLE**  
 21,0 cm, 8¼"

Fig. 00  
**KI-0600-33**

Fig. 0  
**KI-0600-34**

Fig. 1  
**KI-0600-35**



**DAUBENSPECK**  
 20,0 cm, 8"

Fig. 00  
**KI-0600-36**

Fig. 0  
**KI-0600-37**

Fig. 1  
**KI-0600-38**

Fig. 2  
**KI-0600-39**



Scharfe Löffel  
 Bone Curettes  
 Cucharillas cortantes  
 Curetta per ossa



Fig. 1  
**KI-0600-40**



Fig. 2  
**KI-0600-41**

**WILLIGER**  
 17,0 cm, 6<sup>3</sup>/<sub>4</sub>"



Fig. 0  
**KI-0600-42**

Fig. 1  
**KI-0600-43**

**WILLIGER**  
 14,0 cm, 5<sup>1</sup>/<sub>2</sub>"

Fig. 2  
**KI-0600-44**



Fig. 00/0  
**KI-0600-45**  
 14,0 cm, 5<sup>1</sup>/<sub>2</sub>"

Fig. 0/1  
**KI-0600-46**  
 14,0 cm, 5<sup>1</sup>/<sub>2</sub>"

Fig. 1/2  
**KI-0600-47**  
 14,0 cm, 5<sup>1</sup>/<sub>2</sub>"

**MARTINI**  
 14,0 cm, 5<sup>1</sup>/<sub>2</sub>"  
**KI-0600-48**



**VOLKMANN**

**KI-0600-49**  
 13,0 cm, 5"

**KI-0600-50**  
 14,0 cm, 5<sup>1</sup>/<sub>2</sub>"

**KI-0600-51**  
 17,0 cm, 6<sup>3</sup>/<sub>4</sub>"



**JANZEN**  
 15,0 cm, 6"  
**KI-0600-52**



**JANZEN**  
 16,0 cm, 6<sup>1</sup>/<sub>4</sub>"  
**KI-0600-53**

Dissektoren, Elevatorien  
 Dissectors, Elecators  
 Disecadores, Elevadores  
 Dissettori, Elevatori

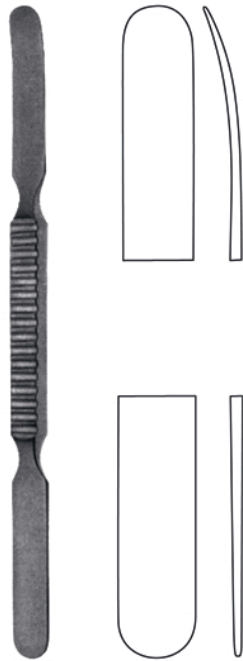

**WATSON-CHEYNE**  
 17,5 cm, 6<sup>5</sup>/<sub>8</sub>"  
 KI-0600-54



**MC DONALD**  
 19,0 cm, 7<sup>1</sup>/<sub>2</sub>"  
 KI-0600-55



**WILLIGER**  
 17,0 cm, 6<sup>3</sup>/<sub>4</sub>"  
 KI-0600-56



**WILLIGER**  
 16,0 cm, 6<sup>1</sup>/<sub>4</sub>"  
 KI-0600-57



**LANGENBECK**  
 20,0 cm, 8"  
 KI-0600-58



**LANGENBECK**  
 20,0 cm, 8"  
 KI-0600-59

Raspatorien  
 Raspatories  
 Periostótomos  
 Periostotomi



**ADSON**  
 17,0 cm, 6<sup>3</sup>/<sub>4</sub>"

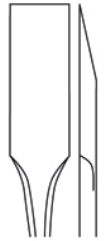

8 mm  
 KI-0600-60



7 mm  
 KI-0600-61



7 mm  
 KI-0600-62



7 mm  
 KI-0600-63



**KÖNIG**  
 15,5 cm, 6"  
 KI-0600-64



5 mm



**LAMBOTTE**  
 21,0 cm, 8<sup>1</sup>/<sub>4</sub>"



10 mm  
 KI-0600-65



15 mm  
 KI-0600-66



20 mm  
 KI-0600-67



25 mm  
 KI-0600-68



**FARBEUF**  
 15,0 cm, 6"  
 KI-0600-69



12,5 mm

Raspatorien  
 Raspatories  
 Periostótomos  
 Periostotomi

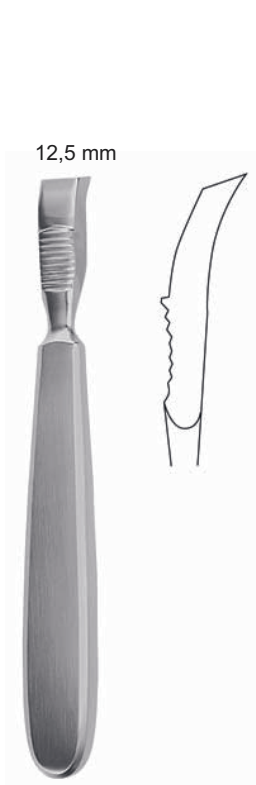

**FARABEU**  
 15,0 cm, 6"  
 KI-0600-70



**LANGENBECK**  
 19,0 cm, 7 1/2"  
 KI-0600-71



**SEDILLOT**  
 21,0 cm, 8 1/4"  
 KI-0600-72



**WILLIGER**  
 16,0 cm, 6 1/4"  
 4 mm KI-0600-73  
 6 mm KI-0600-74  
 8 mm KI-0600-75



für Kinder  
 for children  
 para niños  
 per bambini

**DOYEN**  
 17,0 cm, 6 3/4"  
 KI-0600-76



für Kinder  
 for children  
 para niños  
 per bambini

**DOYEN**  
 17,0 cm, 6 3/4"  
 KI-0600-77



für Erwachsene  
 for adults  
 para adultos  
 per adulti

**DOYEN**  
 17,0 cm, 6 3/4"  
 KI-0600-78



für Erwachsene  
 for adults  
 para adultos  
 per adulti

**DOYEN**  
 17,0 cm, 6 3/4"  
 KI-0600-79

# General Surgery Instruments



"Supporting Healthcare"  
**KAHA INDUSTRIES**  
 Manufacturer Of Dental & Surgical Instruments

Flachmeißel, Hohlmeißel, Osteotome  
 Chisels, Gouges, Osteotomes  
 Cinceles, Gubias, Osteótomos  
 Scalpelli, Sgorbie, Osteotomi

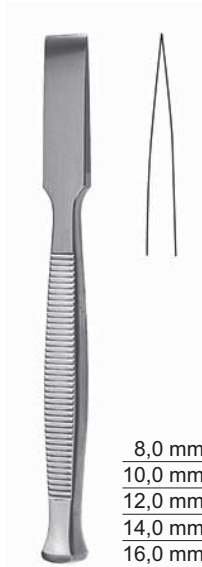

8,0 mm	<b>KI-0600-80</b>
10,0 mm	<b>KI-0600-81</b>
12,0 mm	<b>KI-0600-82</b>
14,0 mm	<b>KI-0600-83</b>
16,0 mm	<b>KI-0600-84</b>

13,5 cm, 5<sup>3</sup>/<sub>8</sub>"



8,0 mm	<b>KI-0600-85</b>
10,0 mm	<b>KI-0600-86</b>
12,0 mm	<b>KI-0600-87</b>
14,0 mm	<b>KI-0600-88</b>
16,0 mm	<b>KI-0600-89</b>

13,5 cm, 5<sup>3</sup>/<sub>8</sub>"



8,0 mm	<b>KI-0600-90</b>
10,0 mm	<b>KI-0600-91</b>
12,0 mm	<b>KI-0600-92</b>
14,0 mm	<b>KI-0600-93</b>
16,0 mm	<b>KI-0600-94</b>

13,5 cm, 5<sup>3</sup>/<sub>8</sub>"



3,0 mm	<b>KI-0600-95</b>
4,0 mm	<b>KI-0600-96</b>
5,0 mm	<b>KI-0600-97</b>
6,0 mm	<b>KI-0600-99</b>

**PARTSCH**  
 13,5 cm, 5<sup>3</sup>/<sub>8</sub>"



3,0 mm	<b>KI-0600-100</b>
4,0 mm	<b>KI-0600-101</b>
5,0 mm	<b>KI-0600-102</b>
6,0 mm	<b>KI-0600-103</b>

**PARTSCH**  
 13,5 cm, 5<sup>3</sup>/<sub>8</sub>"



10,0 mm	<b>KI-0600-104</b>
15,0 mm	<b>KI-0600-105</b>
20,0 mm	<b>KI-0600-106</b>
25,0 mm	<b>KI-0600-107</b>

**STILLE**  
 20,0 cm, 8"

Flachmeißel, Hohlmeißel, Osteotome  
 Chisels, Gouges, Osteotomes  
 Cinceles, Gubias, Osteótomos  
 Scalpelli, Sgorbie, Osteotomi



10,0 mm	<b>KI-0600-108</b>
15,0 mm	<b>KI-0600-109</b>
20,0 mm	<b>KI-0600-110</b>
25,0 mm	<b>KI-0600-111</b>

**STILLE**  
 20,0 cm, 8"



10,0 mm	<b>KI-0600-112</b>
15,0 mm	<b>KI-0600-113</b>
20,0 mm	<b>KI-0600-114</b>
25,0 mm	<b>KI-0600-115</b>

**STILLE**  
 20,0 cm, 8"



4,0 mm	<b>KI-0600-116</b>
6,0 mm	<b>KI-0600-117</b>
8,0 mm	<b>KI-0600-118</b>
10,0 mm	<b>KI-0600-119</b>
12,0 mm	<b>KI-0600-120</b>
14,0 mm	<b>KI-0600-121</b>

**ALEXANDER**  
 18,0 cm, 7"



4,0 mm	<b>KI-0600-122</b>
6,0 mm	<b>KI-0600-123</b>
8,0 mm	<b>KI-0600-124</b>
10,0 mm	<b>KI-0600-125</b>
12,0 mm	<b>KI-0600-126</b>
14,0 mm	<b>KI-0600-127</b>

**ALEXANDER**  
 18,0 cm, 7"



6,0 mm	<b>KI-0600-128</b>
9,0 mm	<b>KI-0600-129</b>
13,0 mm	<b>KI-0600-130</b>
16,0 mm	<b>KI-0600-131</b>
19,0 mm	<b>KI-0600-132</b>
25,0 mm	<b>KI-0600-133</b>
32,0 mm	<b>KI-0600-134</b>

**SMITH-PETERSEN**  
 20,0 cm, 8"



6,0 mm	<b>KI-0600-135</b>
9,0 mm	<b>KI-0600-136</b>
13,0 mm	<b>KI-0600-137</b>
16,0 mm	<b>KI-0600-138</b>
19,0 mm	<b>KI-0600-139</b>
25,0 mm	<b>KI-0600-140</b>
32,0 mm	<b>KI-0600-141</b>

**SMITH-PETERSEN**  
 20,0 cm, 8"

# General Surgery Instruments



"Supporting Healthcare"  
**KAHA INDUSTRIES**  
 Manufacturer Of Dental & Surgical Instruments

Flachmeißel, Hohlmeißel, Osteotome, Hämmer  
 Chisels, Gouges, Osteotomes, Mallets  
 Cinceles, Gubias, Osteótomos, Martillos  
 Scalpelli, Sgorbie, Osteotomi, Martelli



9,0 mm	KI-0600-142
14,0 mm	KI-0600-143
16,0 mm	KI-0600-144
19,0 mm	KI-0600-145
25,0 mm	KI-0600-146

**SMITH-PETERSEN**  
 20,0 cm, 8"



9,0 mm	KI-0600-147
14,0 mm	KI-0600-148
16,0 mm	KI-0600-149
19,0 mm	KI-0600-150
25,0 mm	KI-0600-151

**SMITH-PETERSEN**  
 20,0 cm, 8"



6,0 mm	KI-0600-152
15,0 mm	KI-0600-153
20,0 mm	KI-0600-154
25,0 mm	KI-0600-155
30,0 mm	KI-0600-156
38,0 mm	KI-0600-157
44,0 mm	KI-0600-158
50,0 mm	KI-0600-159

**LAMBOTTE**  
 24,0 cm, 9 1/2"



6,0 mm	KI-0600-160
15,0 mm	KI-0600-161
20,0 mm	KI-0600-162
25,0 mm	KI-0600-163
30,0 mm	KI-0600-164
38,0 mm	KI-0600-165
44,0 mm	KI-0600-166
50,0 mm	KI-0600-167

**LAMBOTTE**  
 24,0 cm, 9 1/2"



Ø 30 mm  
 220 g

**COLLIN**  
 20,0 cm, 8"  
 KI-0600-168



Ø 22 mm  
 200 g

mit Bleifüllung  
 lead filled head  
 cabezal relleno de plomo  
 testa di piombo

**PARTSCH**  
 18,0 cm, 7"  
 KI-0600-169



Ø 45 mm  
 300 g

**BERGMANN**  
 24,0 cm, 9 1/2"  
 KI-0600-170



“Supporting Healthcare”

**KAAHA INDUSTRIES**

Manufacturer Of Dental & Surgical Instruments

**C15**  
296 to 299



**AKerilisation**

**AKerilization**

**EAKerilización**

**AKerilizzazione**



Sterilisierzangen  
Sterilizing Forceps  
Pinzas para esterilización  
Pinze per sterilizzazione



20,0 cm, 8"  
KI-0700-01



**CHEATTLE**  
27,0 cm, 10<sup>5</sup>/<sub>8</sub>"  
KI-0700-02



**ROGGE**  
23,0 cm, 9"  
KI-0700-03



**PYE-SMITH (HARRISON)**  
30,0 cm, 12"  
KI-0700-04



**MAYO**  
14,0 cm, 5<sup>1</sup>/<sub>2</sub>"  
KI-0700-05



**BUNT**  
12,0 cm, 4<sup>3</sup>/<sub>4</sub>"  
KI-0700-06

**Schalen**  
**Trays**  
**Bandejas**  
**Bacinelle**



**STANDZYLINDER**

Ø 75 x 130 mm	<b>KI-0700-07</b>
Ø 75 x 175 mm	<b>KI-0700-08</b>
Ø 100 x 175 mm	<b>KI-0700-09</b>
Ø 100 x 200 mm	<b>KI-0700-10</b>



**RUNDE SCHALE**

Ø 40,0 mm	<b>KI-0700-11</b>
Ø 60,0 mm	<b>KI-0700-12</b>
Ø 80,0 mm	<b>KI-0700-13</b>
Ø 100,0 mm	<b>KI-0700-14</b>
Ø 120,0 mm	<b>KI-0700-15</b>
Ø 150,0 mm	<b>KI-0700-16</b>



**SPÜLSCHALE**

165 x 55 mm	0,75 l	<b>KI-0700-17</b>
175 x 70 mm	1,00 l	<b>KI-0700-18</b>
225 x 100 mm	2,00 l	<b>KI-0700-19</b>
240 x 95 mm	2,75 l	<b>KI-0700-20</b>
260 x 120 mm	4,00 l	<b>KI-0700-21</b>
290 x 100 mm	5,00 l	<b>KI-0700-22</b>
315 x 150 mm	5,50 l	<b>KI-0700-23</b>
325 x 135 mm	8,00 l	<b>KI-0700-24</b>
360 x 165 mm	12,00 l	<b>KI-0700-25</b>
415 x 150 mm	14,00 l	<b>KI-0700-26</b>



**NIERENSCHALE**

170 mm	<b>KI-0700-27</b>
250 mm	<b>KI-0700-28</b>
275 mm	<b>KI-0700-29</b>

Schalen  
 Trays  
 Bandejas  
 Bacinelle



**INSTRUMENTENKÄSTCHEN**

200 x 150 x 25 mm	<b>KI-0700-30</b>
260 x 180 x 30 mm	<b>KI-0700-31</b>
300 x 220 x 30 mm	<b>KI-0700-32</b>
350 x 220 x 40 mm	<b>KI-0700-33</b>
220 x 170 x 50 mm	<b>KI-0700-34</b>
280 x 200 x 50 mm	<b>KI-0700-35</b>
320 x 240 x 50 mm	<b>KI-0700-36</b>
370 x 270 x 50 mm	<b>KI-0700-37</b>
420 x 320 x 50 mm	<b>KI-0700-38</b>



**NAEDELDOSE**

**KI-0700-39**

Ø 65 x 17 mm

Außen- und Innendose

Exterior and interior box

Caja exterior e interior

Scatola esterna es interiore

**KI-0700-40**

Ø 62 x 13 mm

Innendose allein

Interior box only

Caja interior, suelta

Scatola interiore sola



**SPÜLSCHALE  
 MIT SKALIERUNG**

25 ccm

**KI-0700-41**



**SPÜLBECHER  
 MIT SKALIERUNG**

50 ccm

**KI-0700-42**

# General Surgery Instruments Catalogue



“Supporting Healthcare”

**KAAHA INDUSTRIES**

Manufacturer Of Dental & Surgical Instruments

☎ +92-300-717-1438

☎ +92-52-353-1555

☎ +92-52-353-1555

✉ sales@kaahaindustries.com

✉ info@kaahaindustries.com

🌐 www.kaahaindustries.com

📍 Head Marala Road, Kotli Loharan East, P.O.Box 51220 - Sialkot - Pakistan.

